

# EKS + EKX

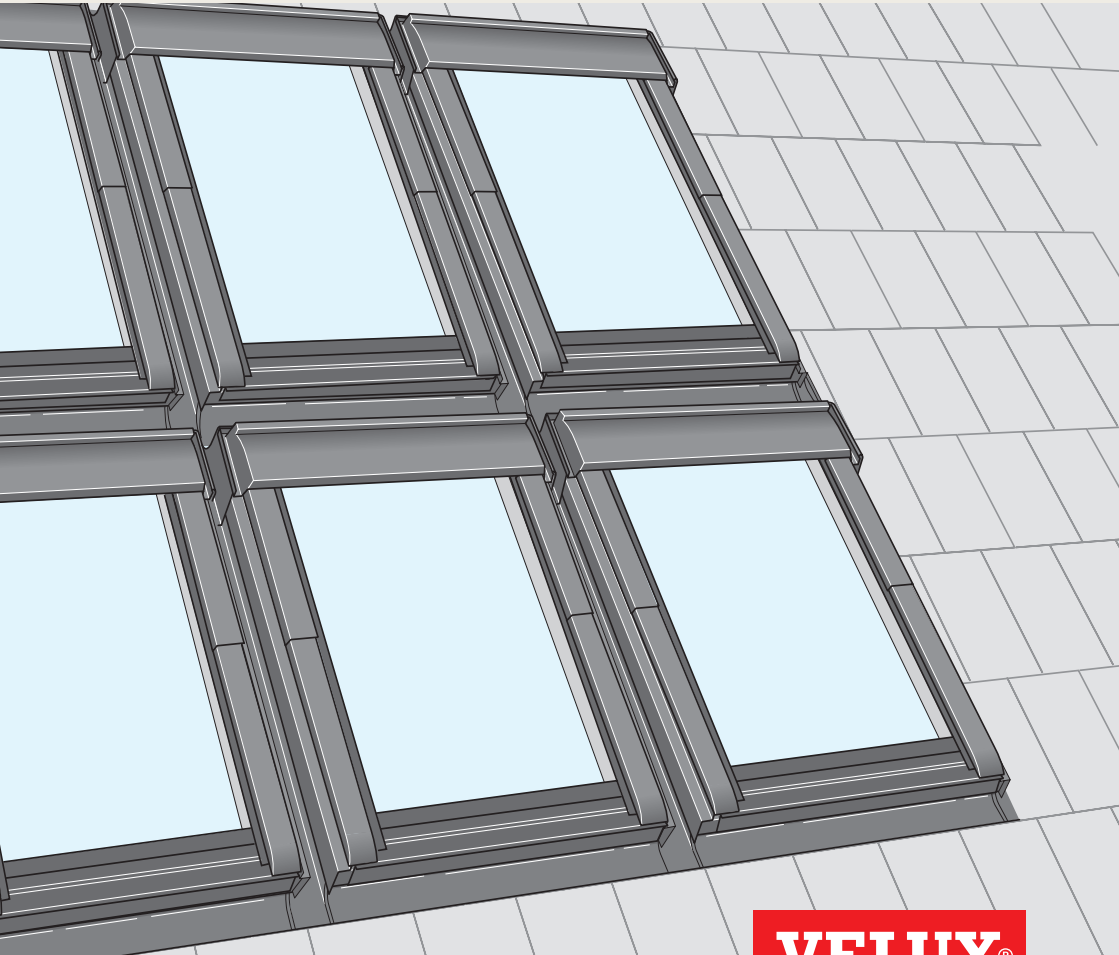

VAS 455049-2024-10



0001



0002



0003

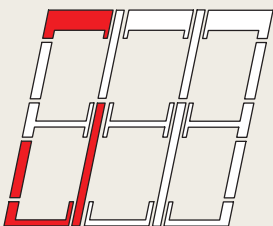

0001

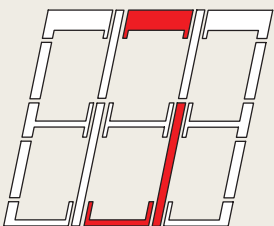

0002

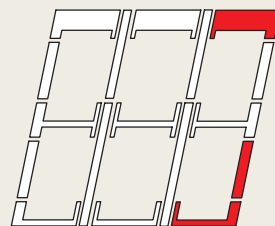

0003

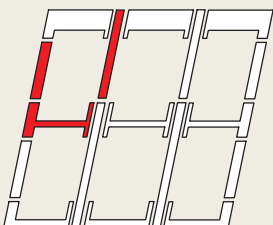

0004

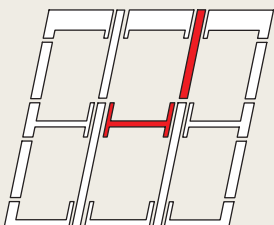

0005

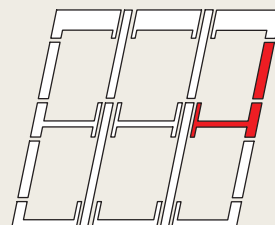

0006



**a = 100 - 160 mm**

**b = xx mm**

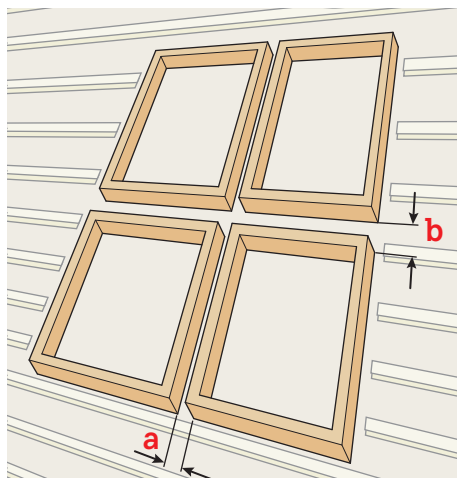
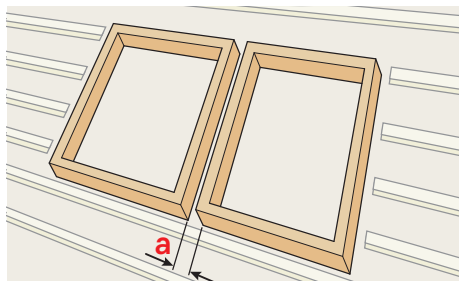

1

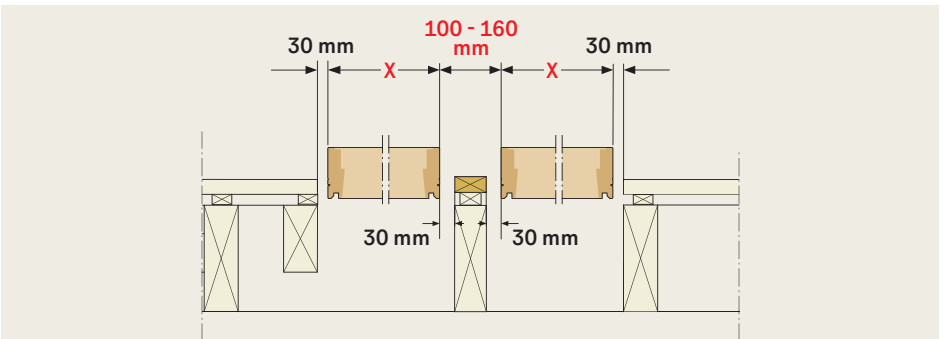
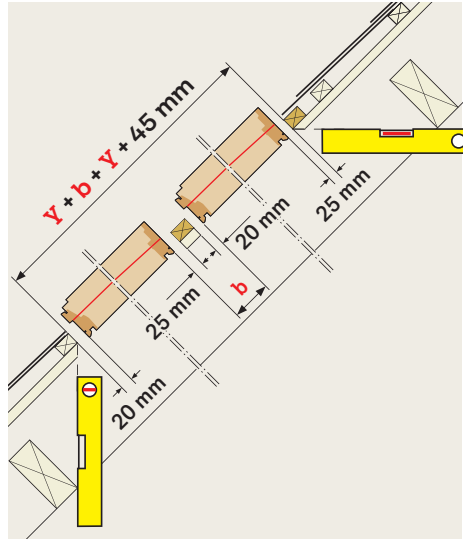
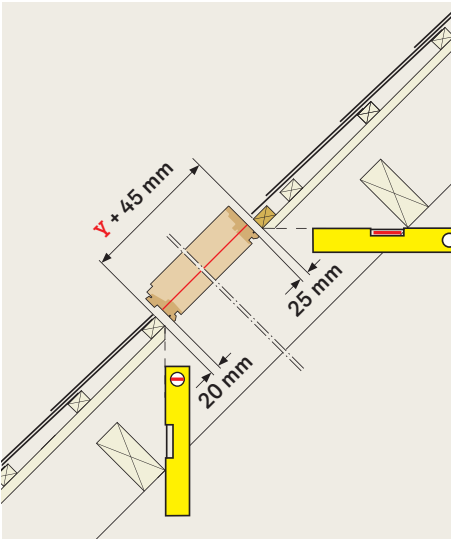
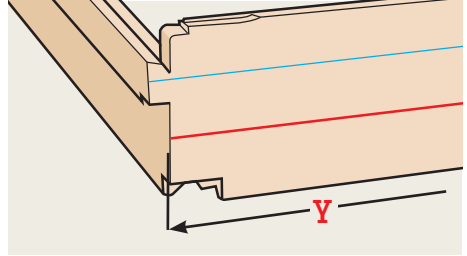
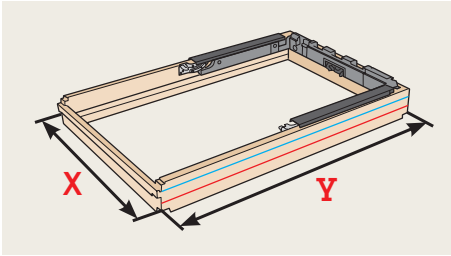
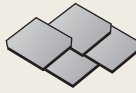
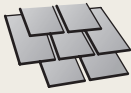

2

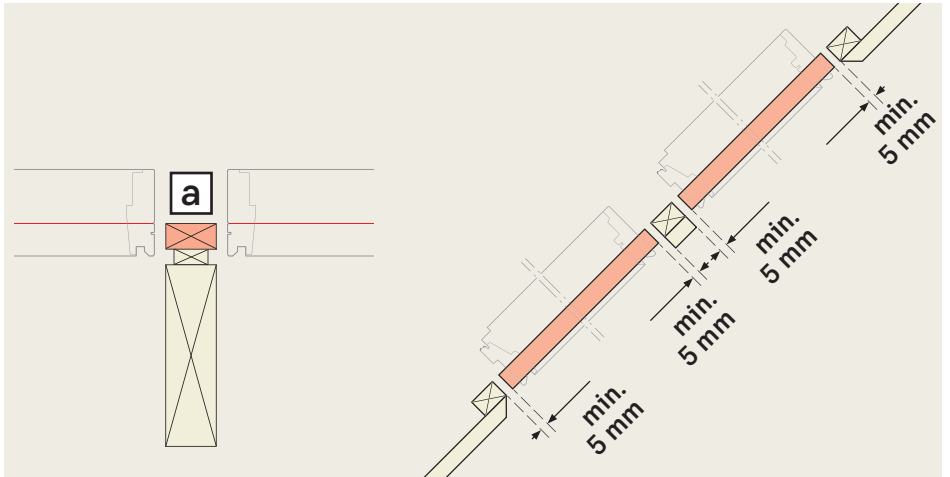
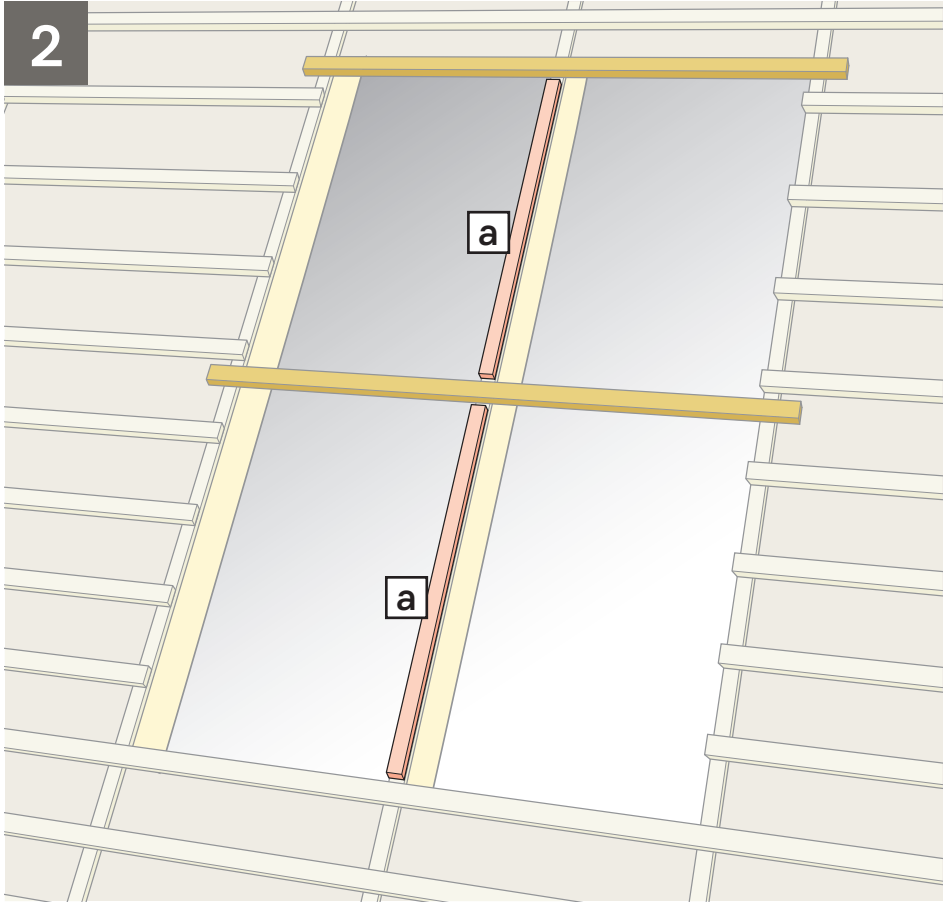



3

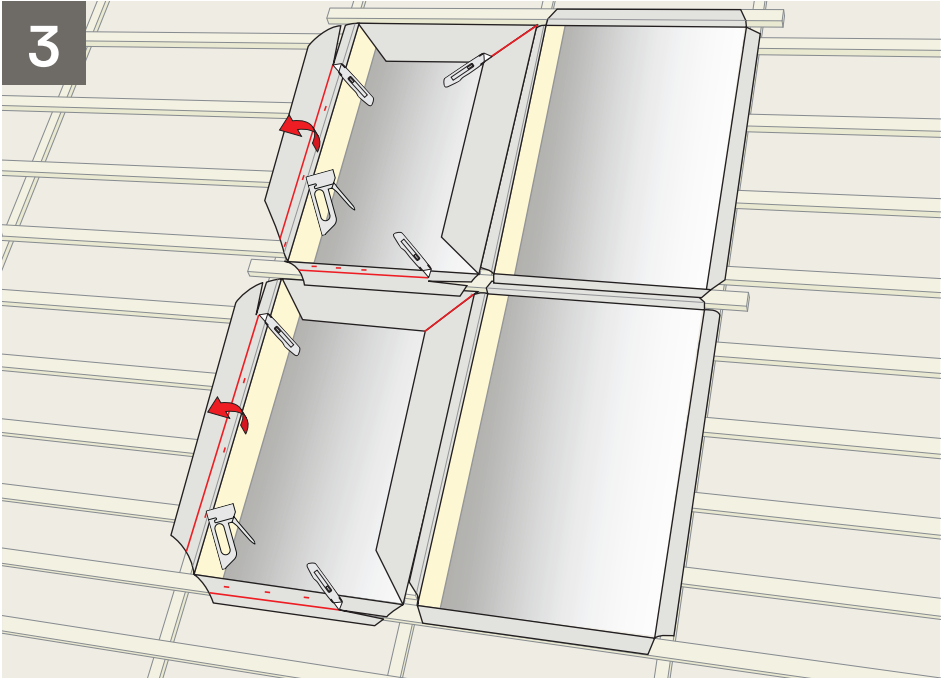

4

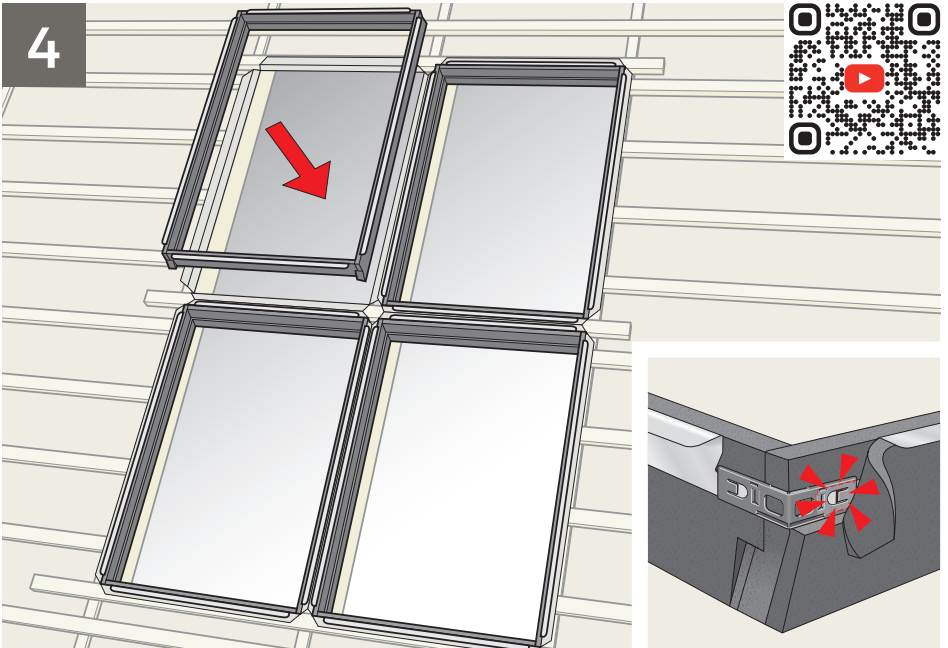

5

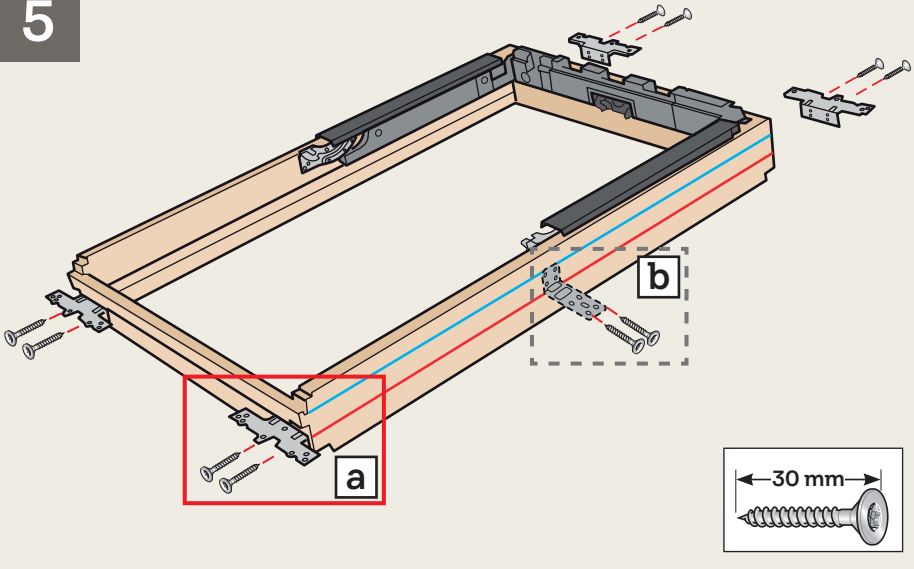

a

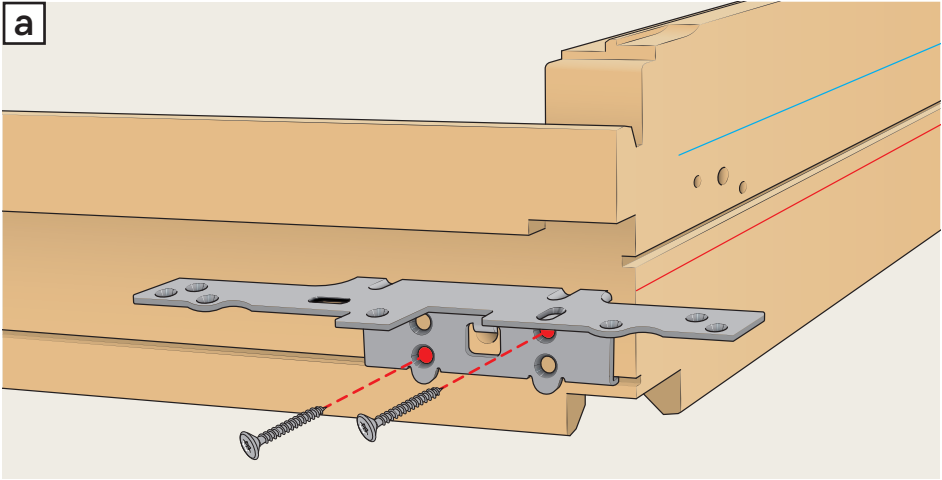

b

- K08
- K10
- K12

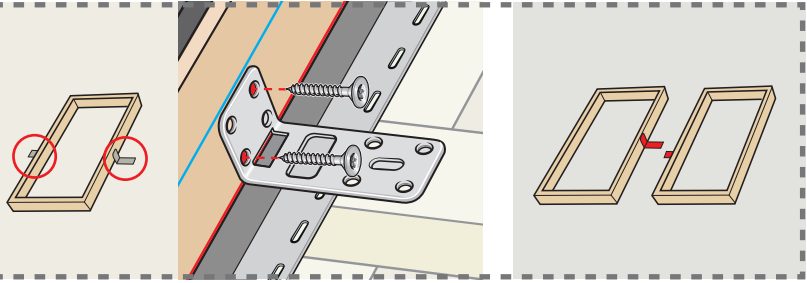

6

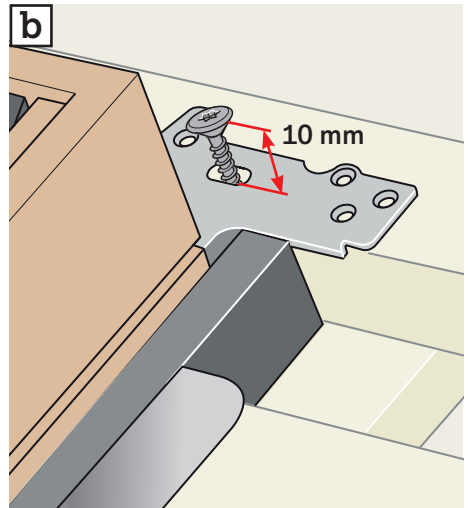
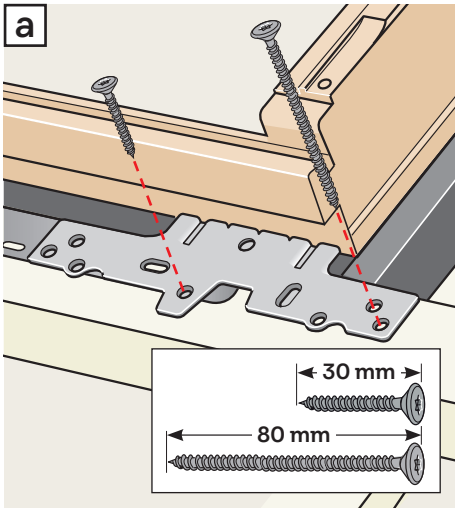
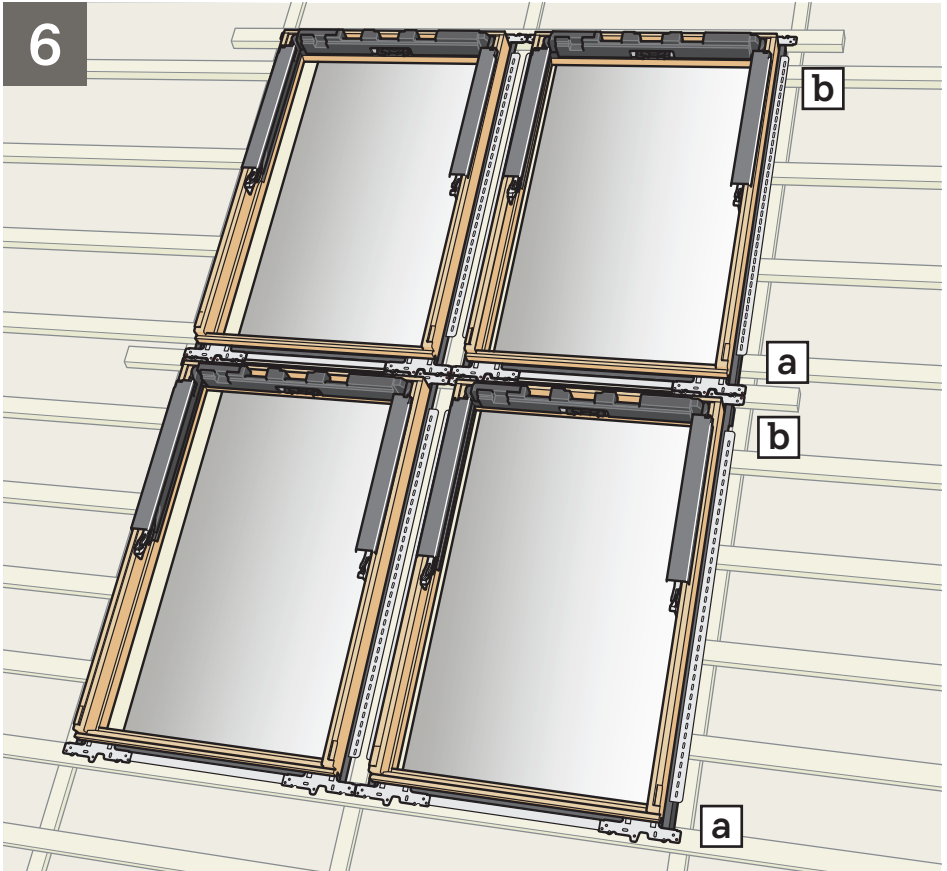

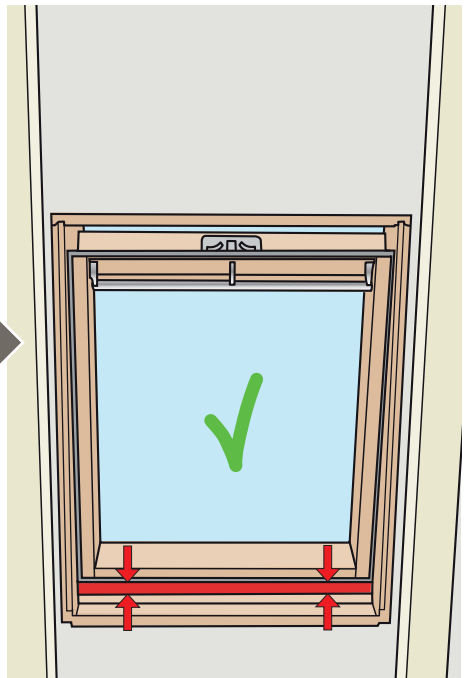
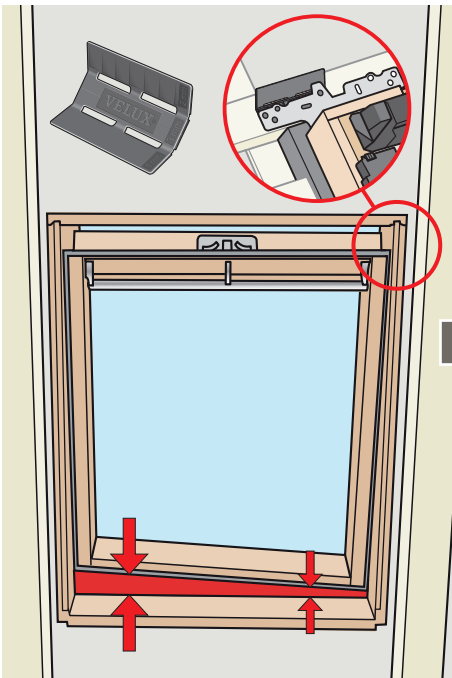
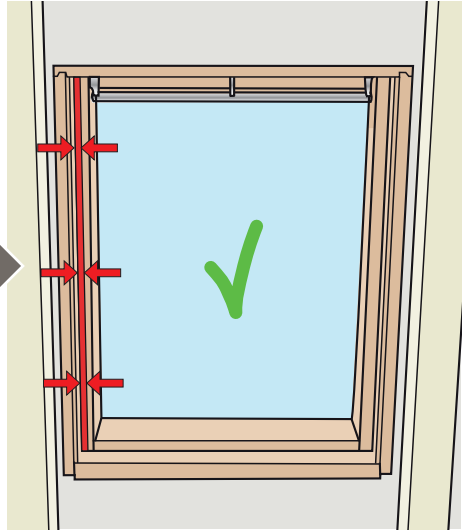
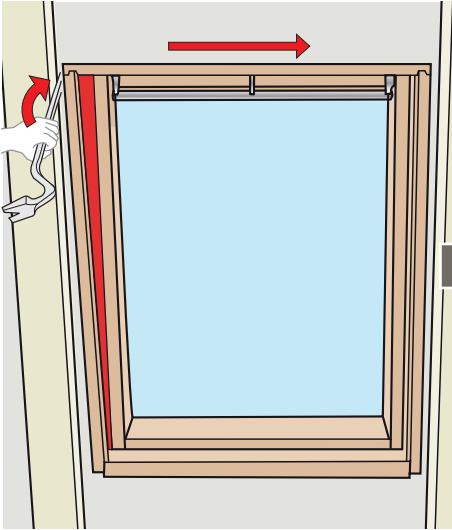

8

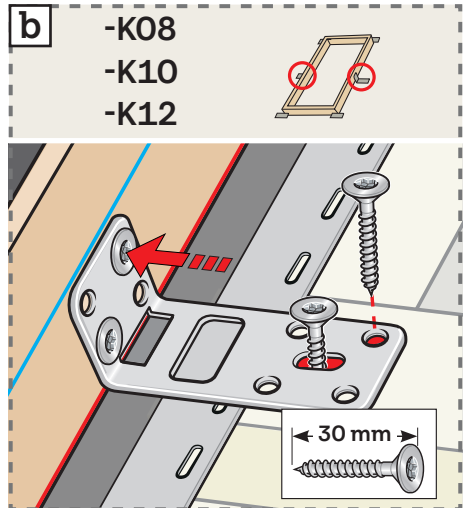
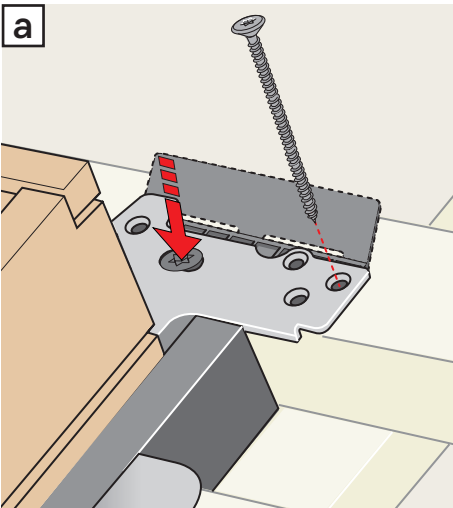
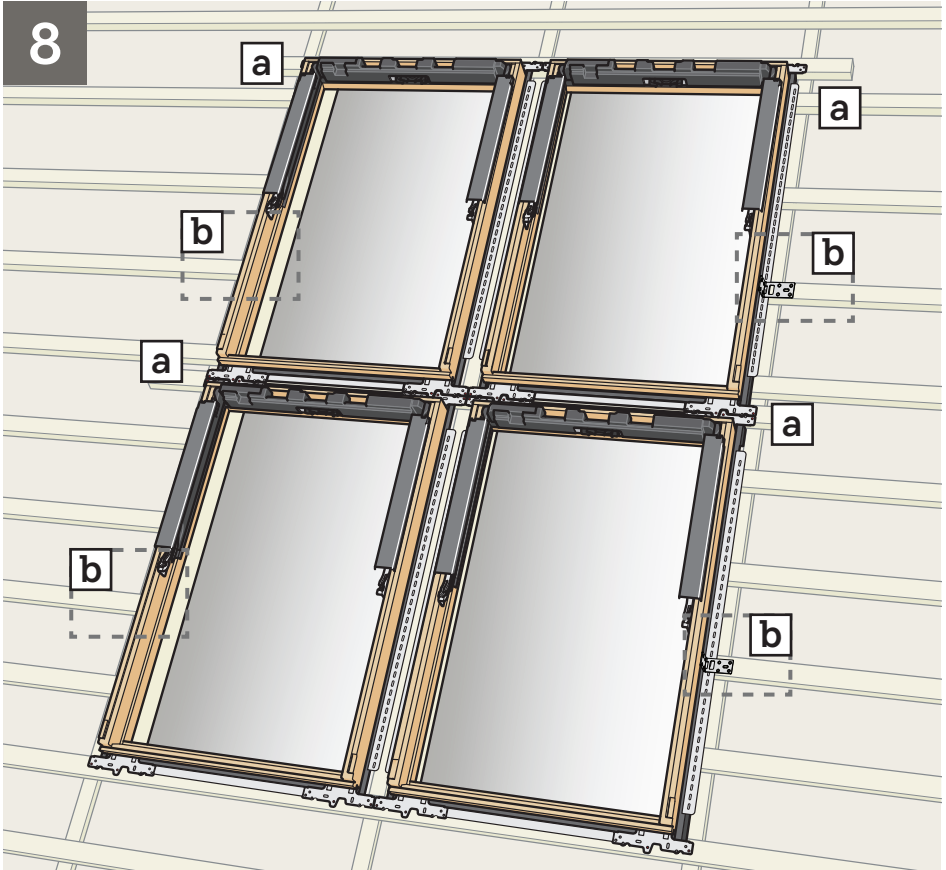

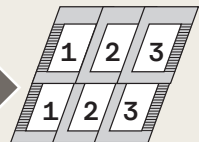
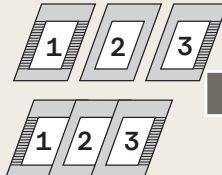
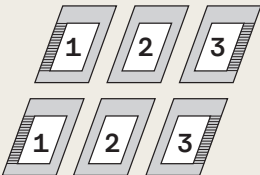
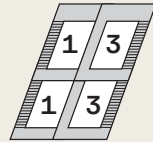
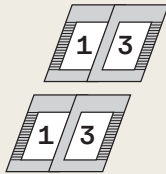
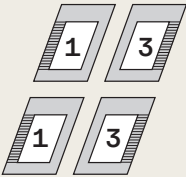
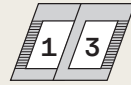
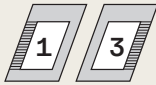
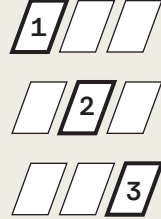
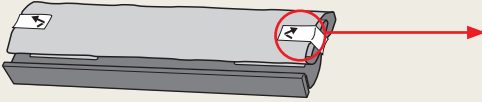
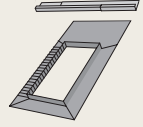

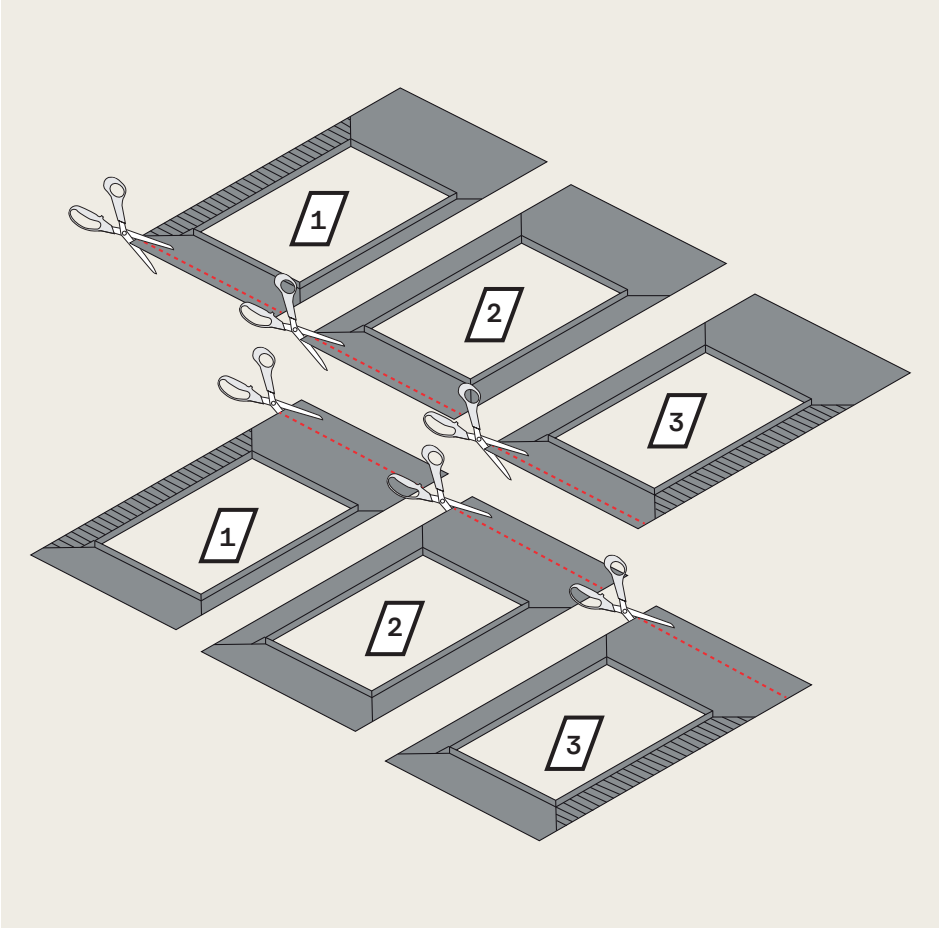

9

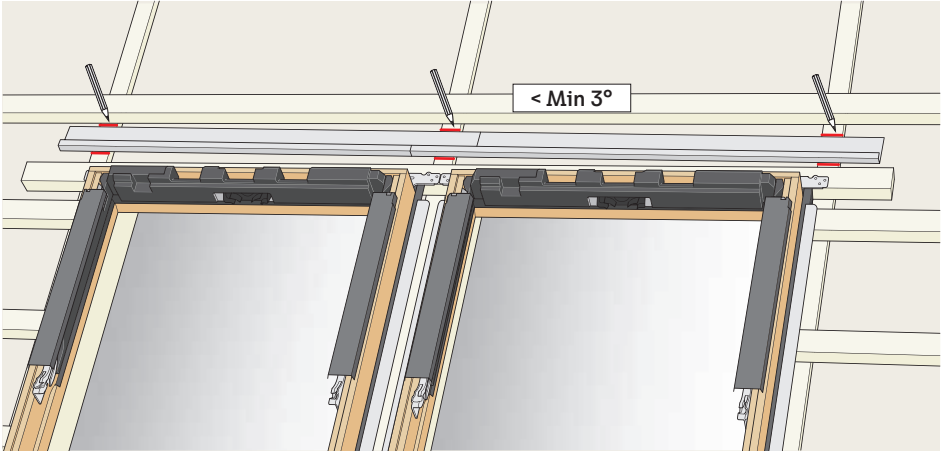

10

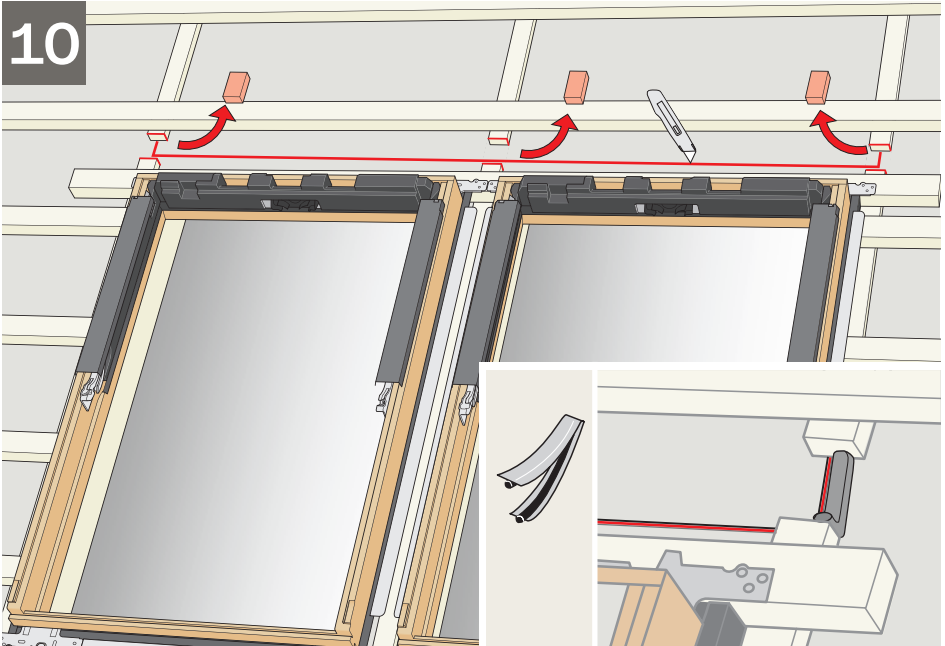



11

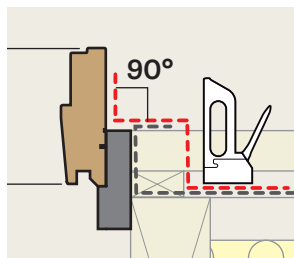
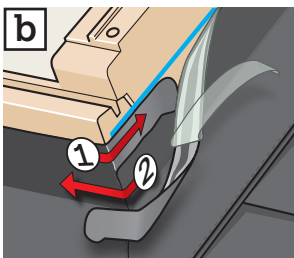
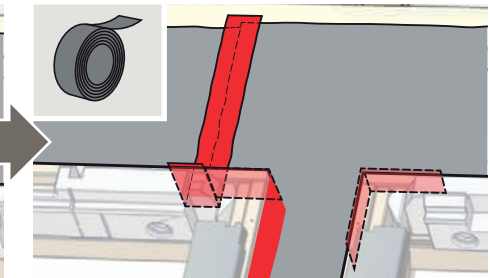
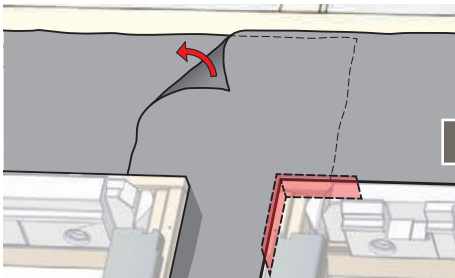
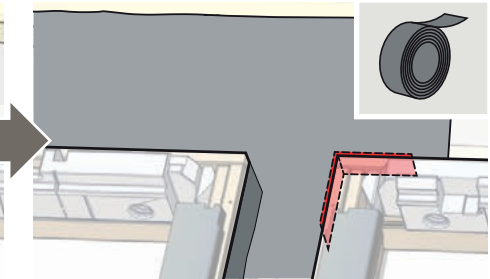
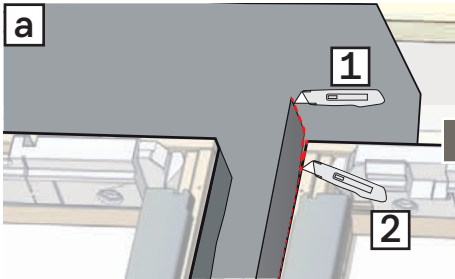
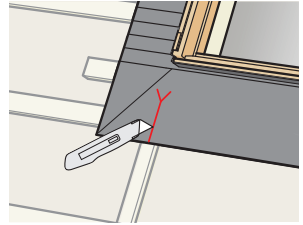
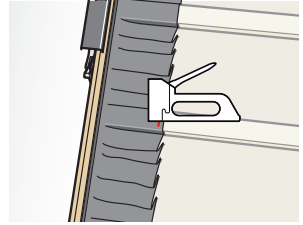
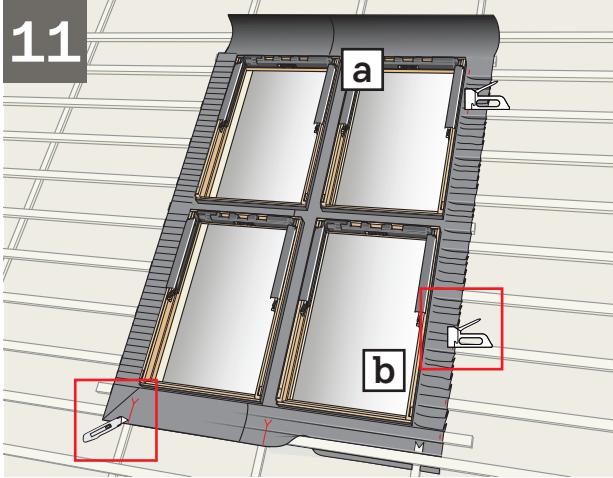

12

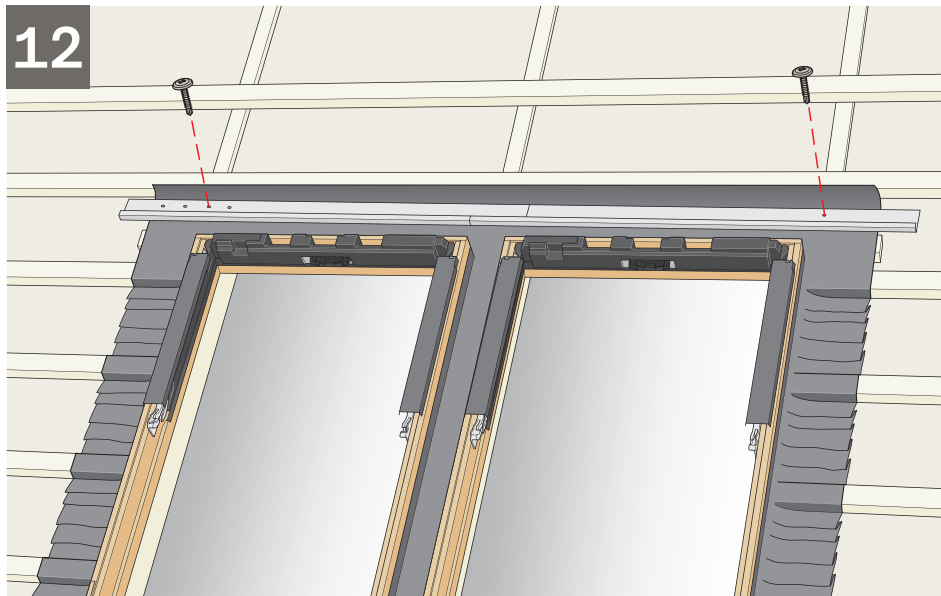

13

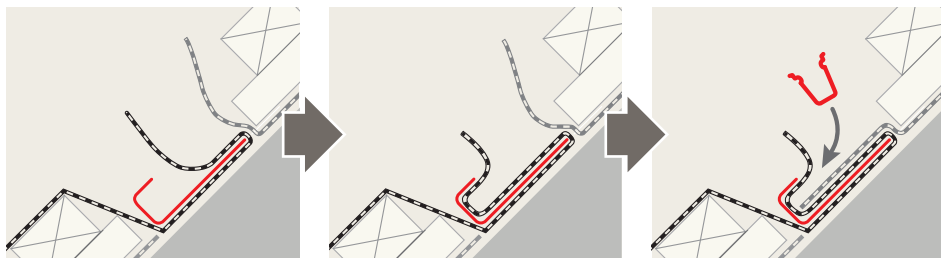

14

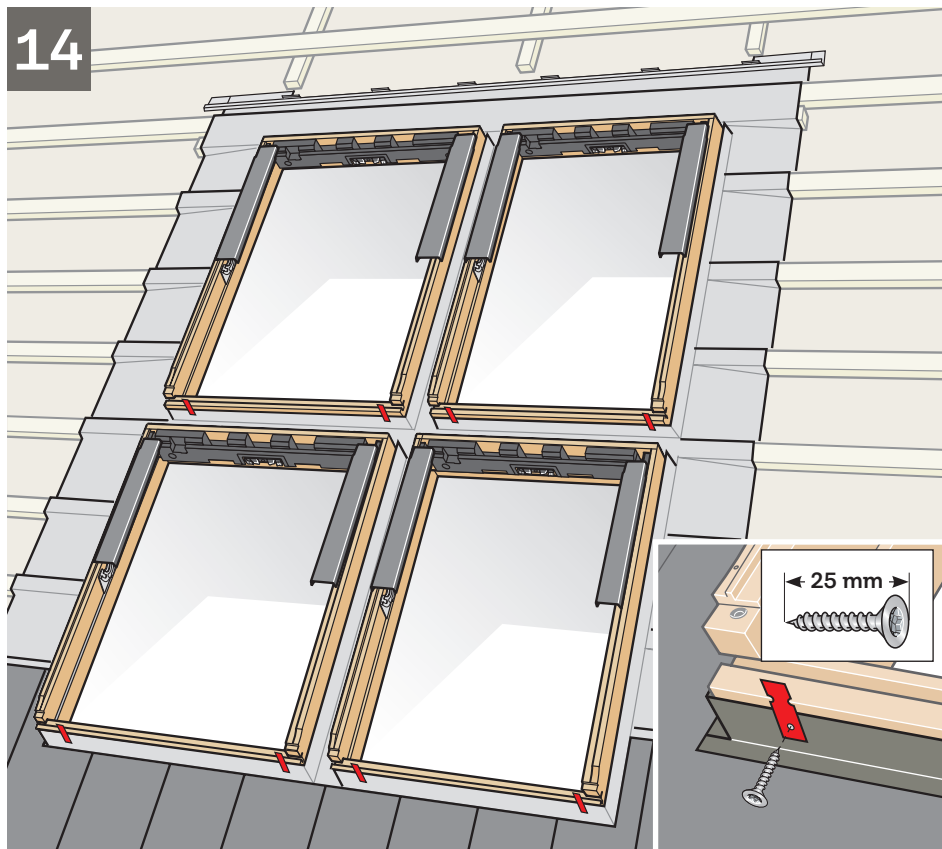

15

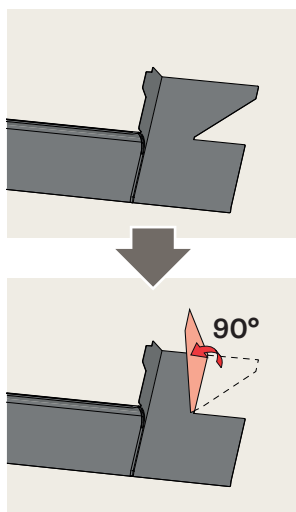
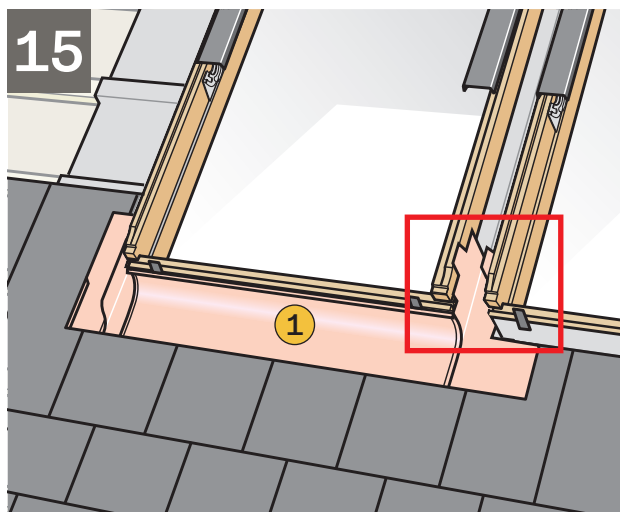

16

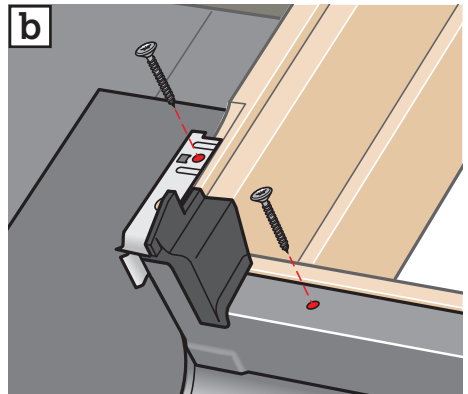
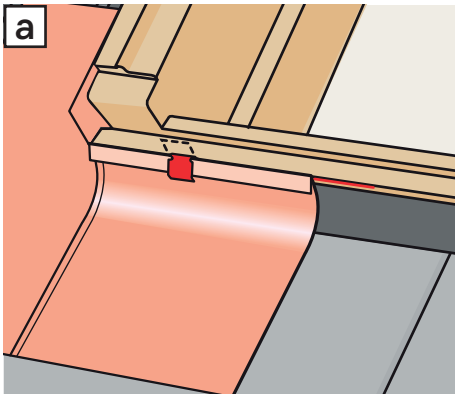
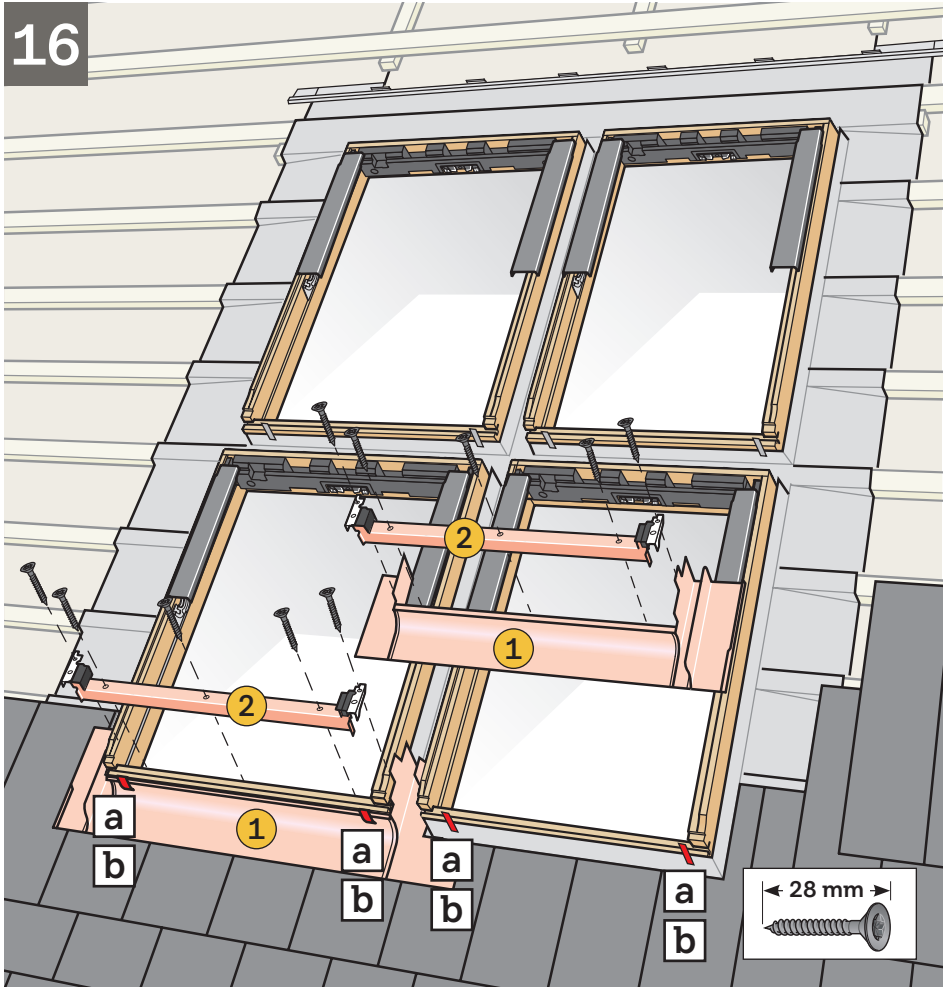

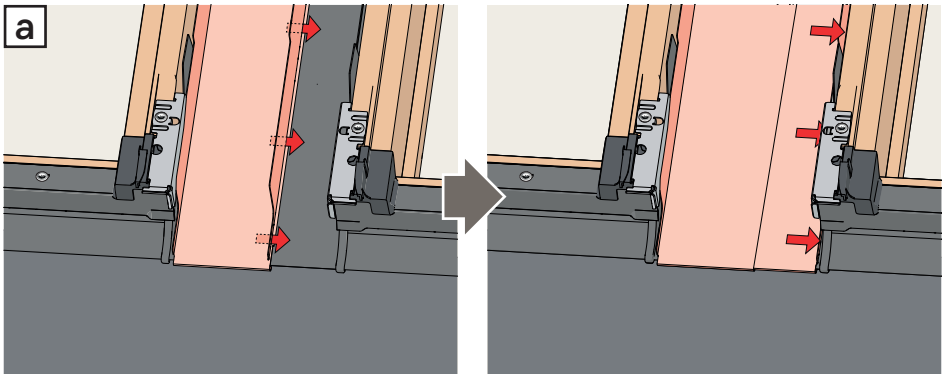
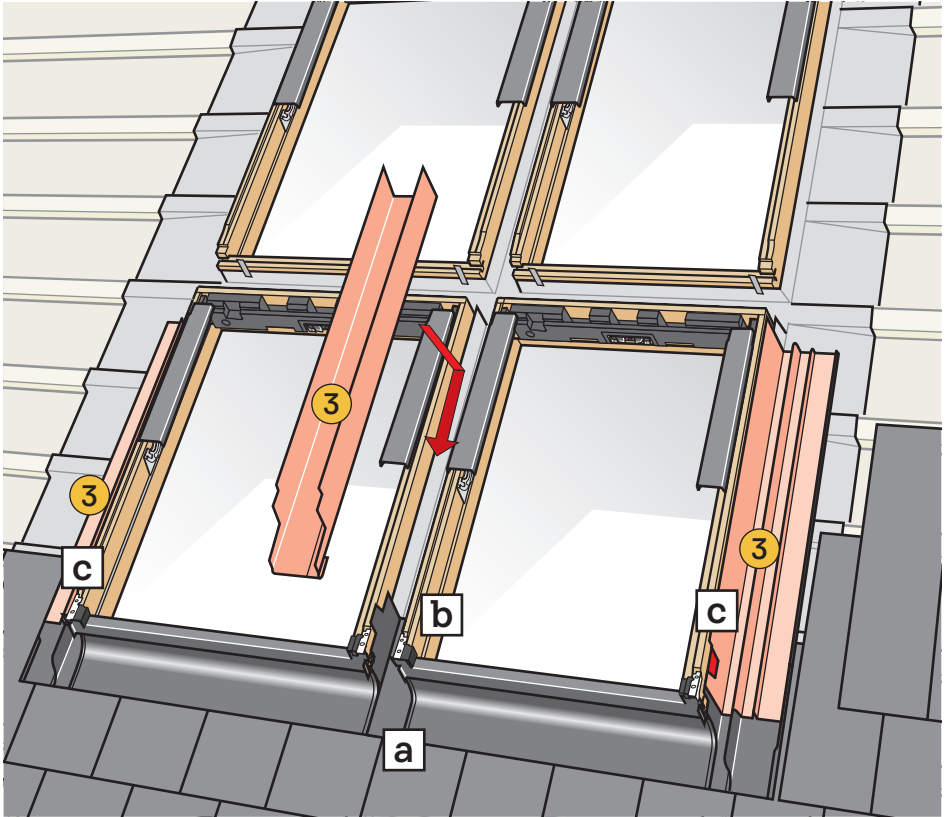

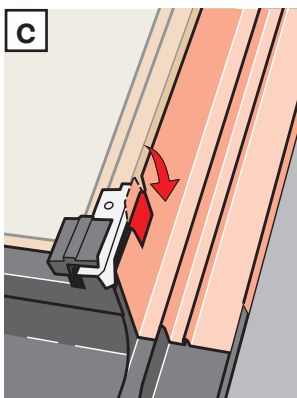
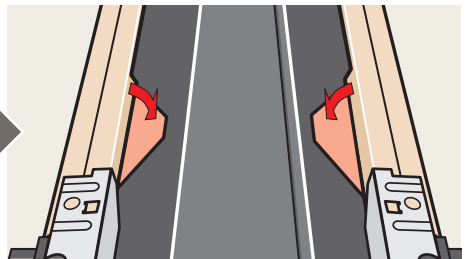
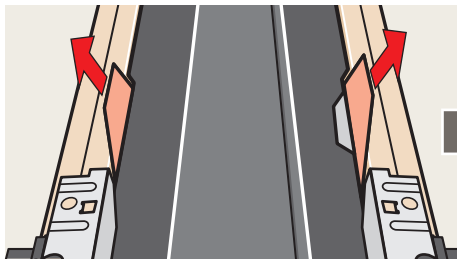
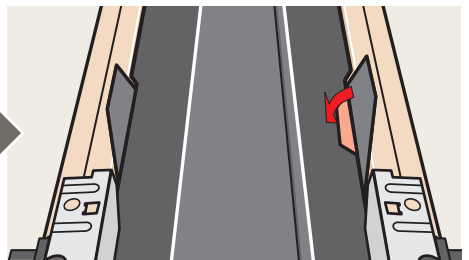
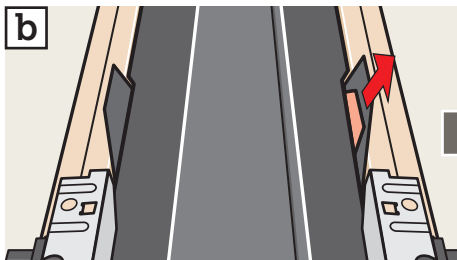
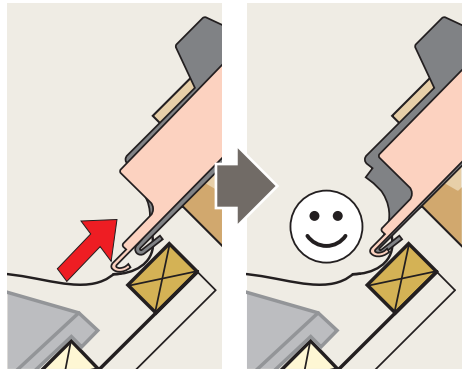
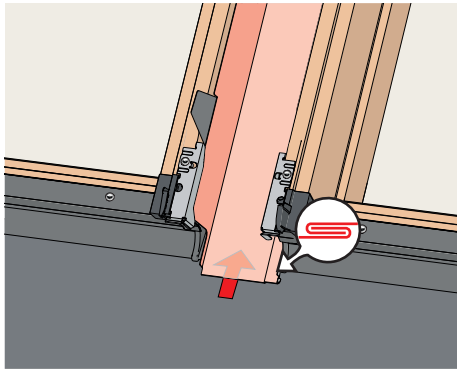

18

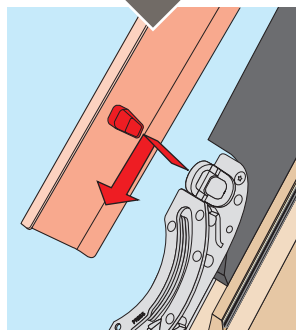
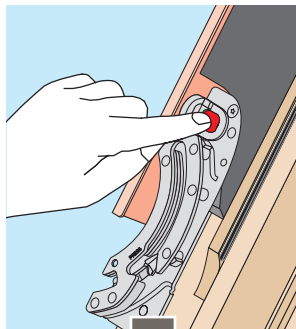
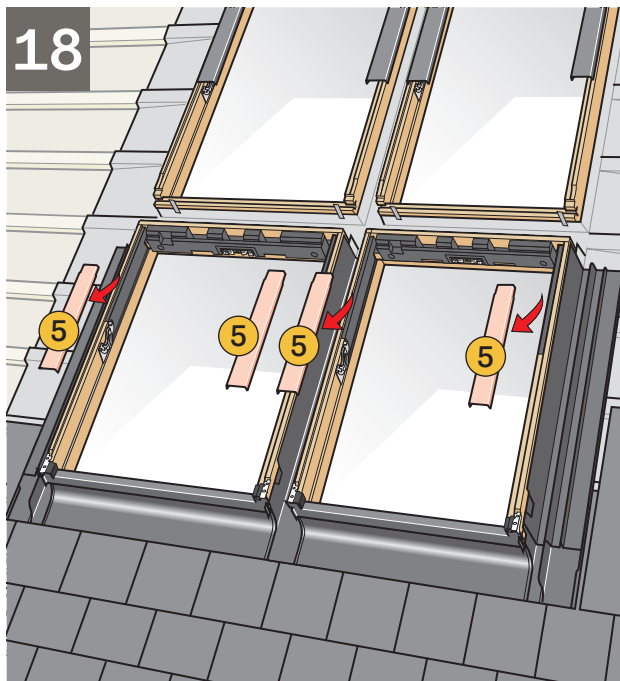

19

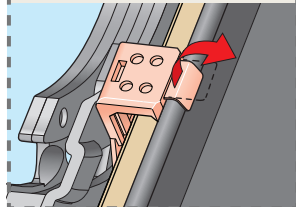
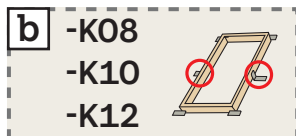
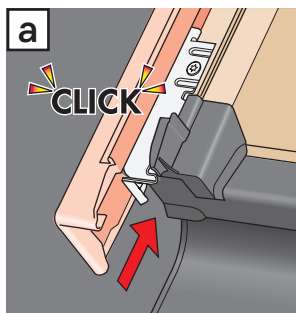
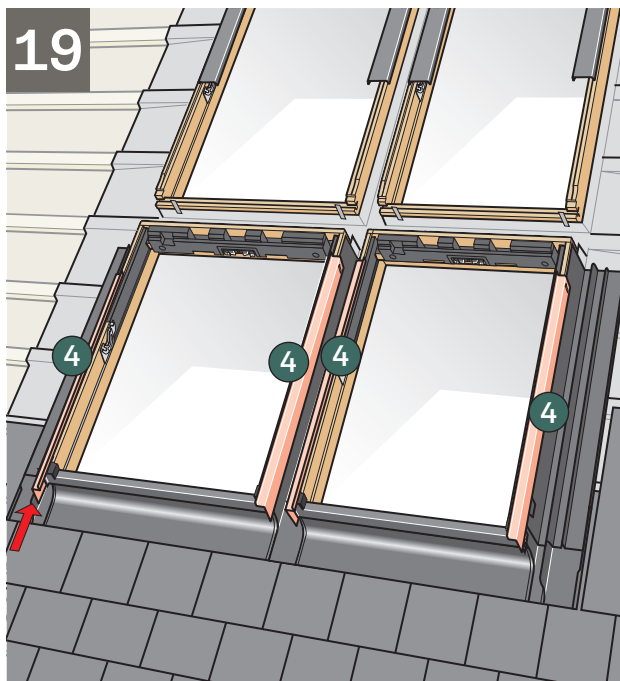

20

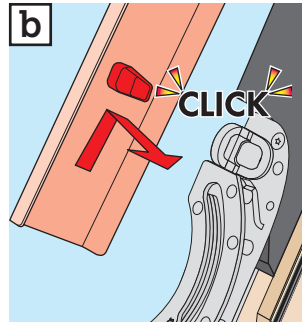
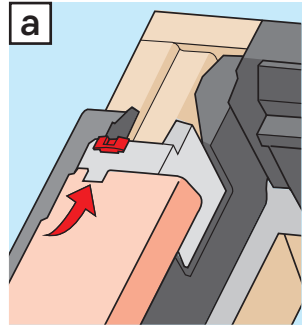
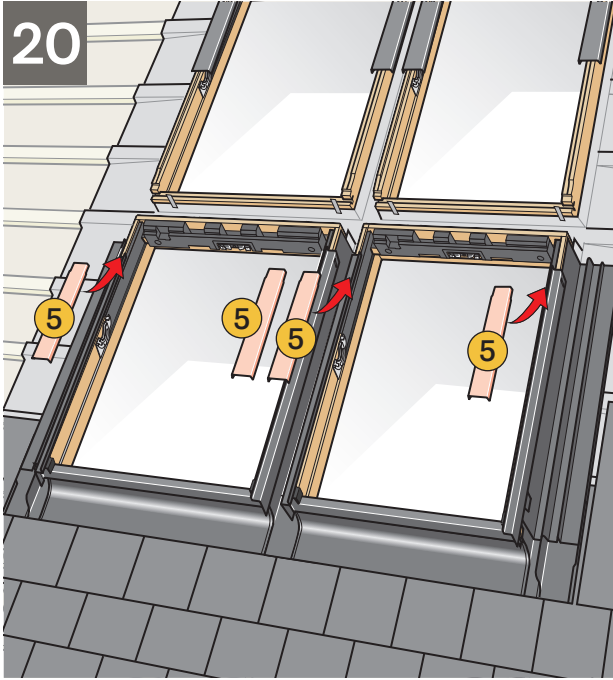



21

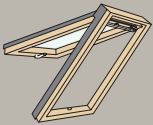
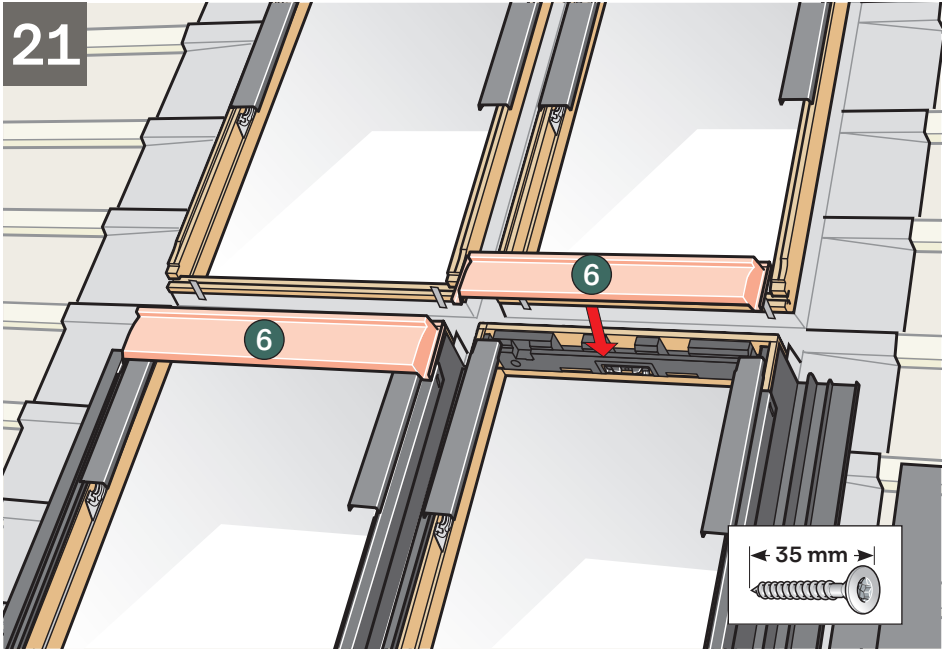

GPL / GPU / GTL / GTU / GDL

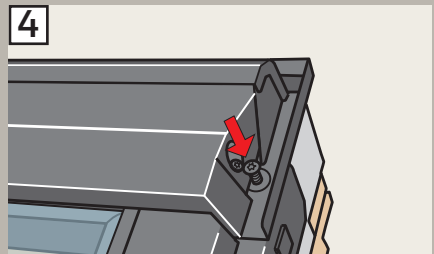
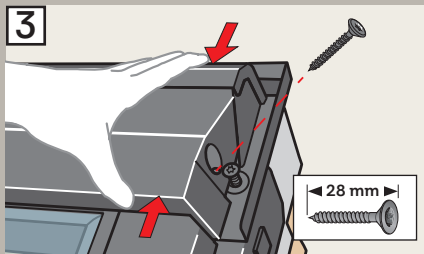
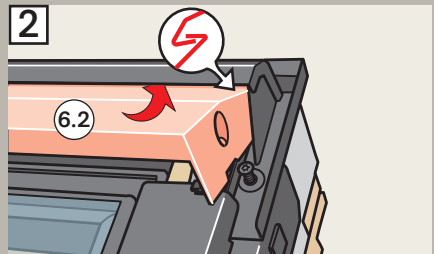
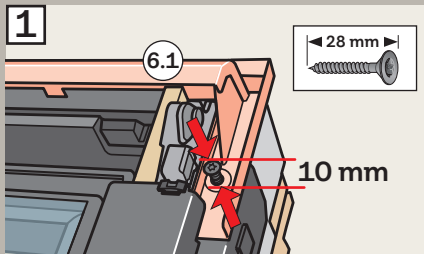

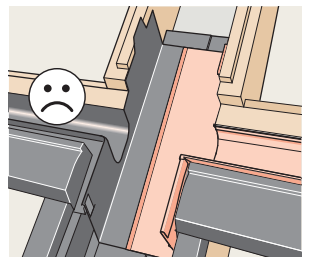
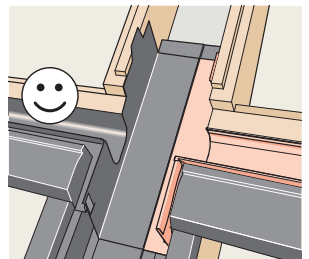
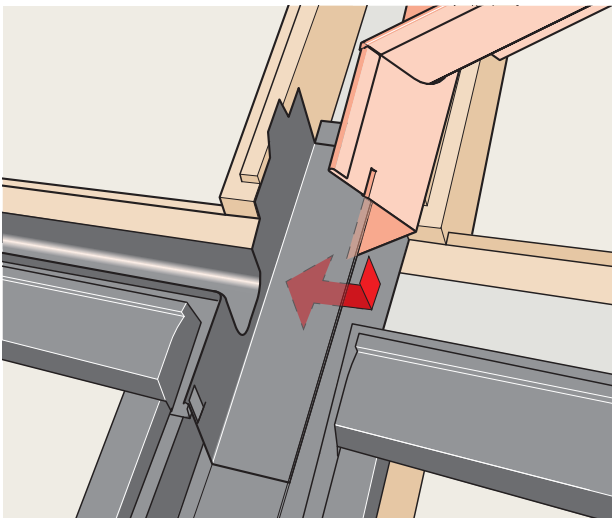
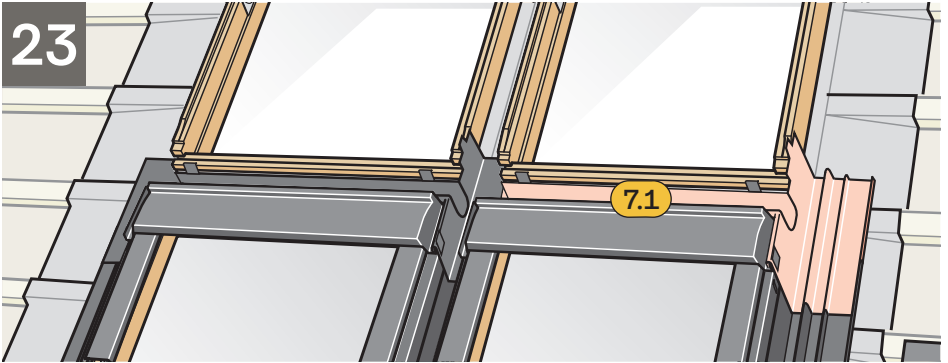
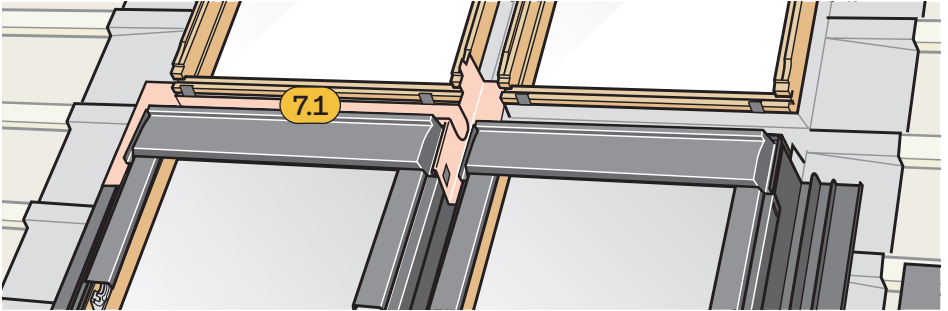

24

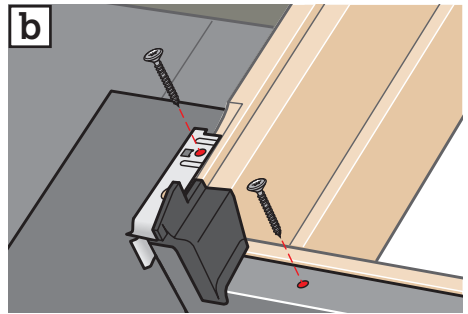
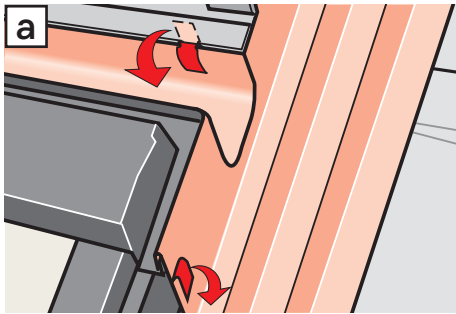
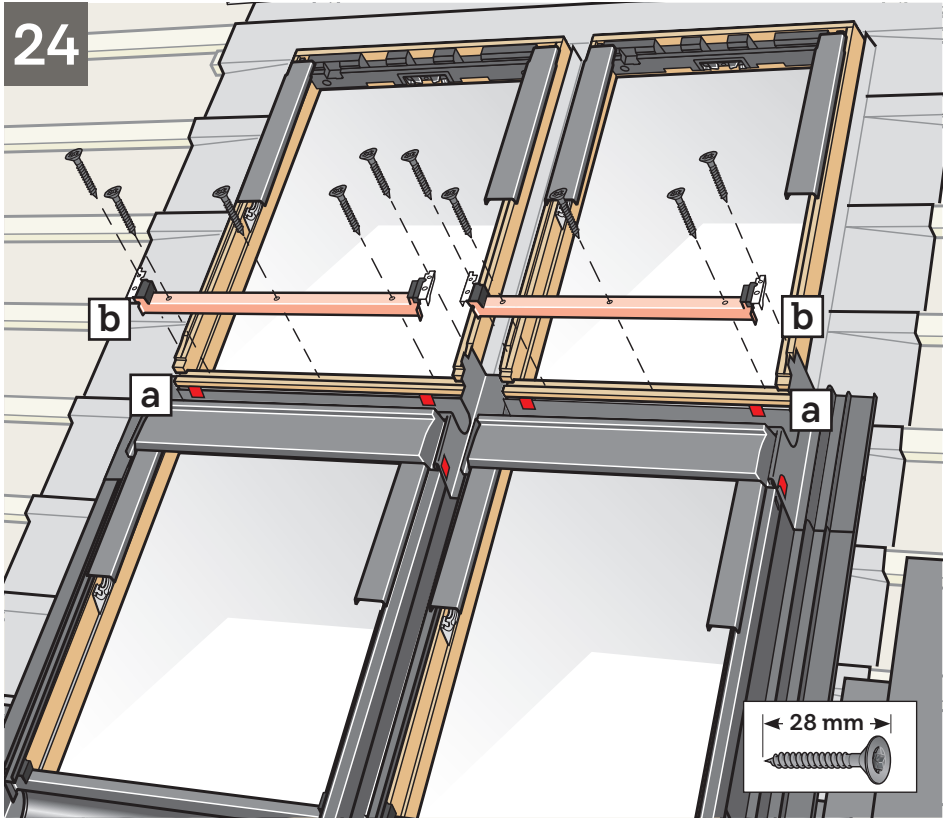

25

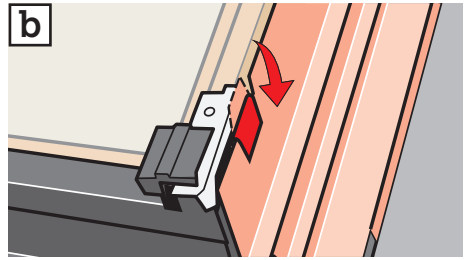
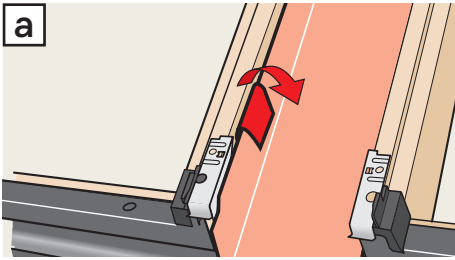
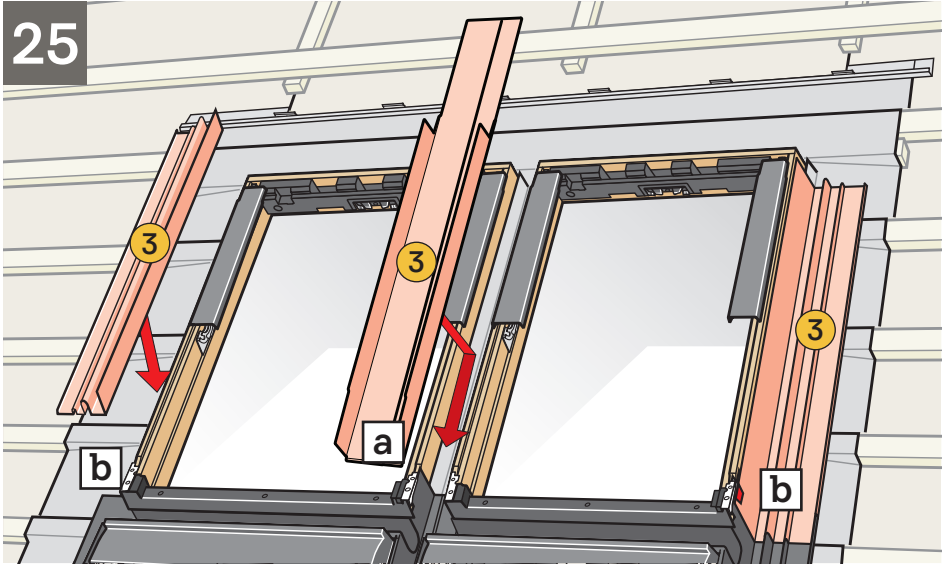

26

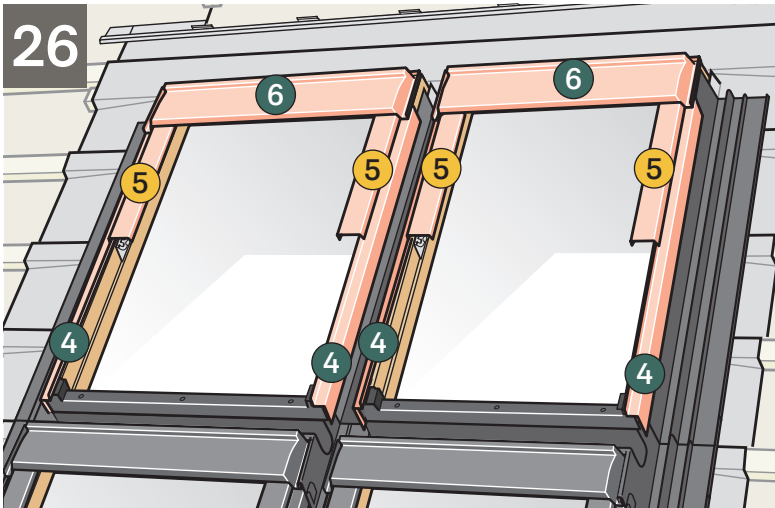

18

19

20

21

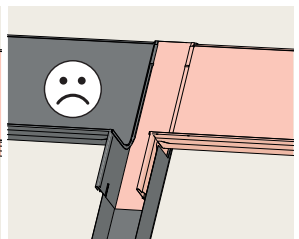
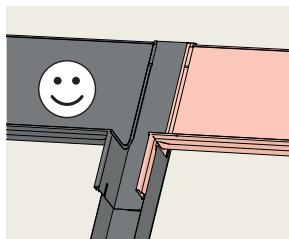
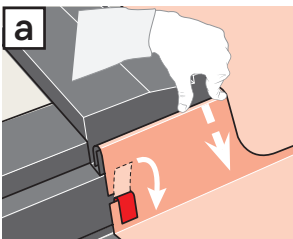
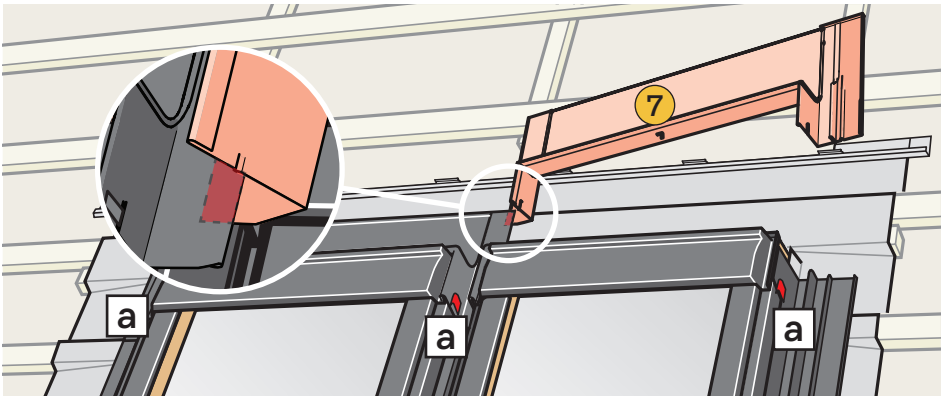
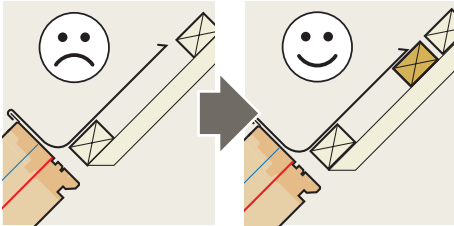
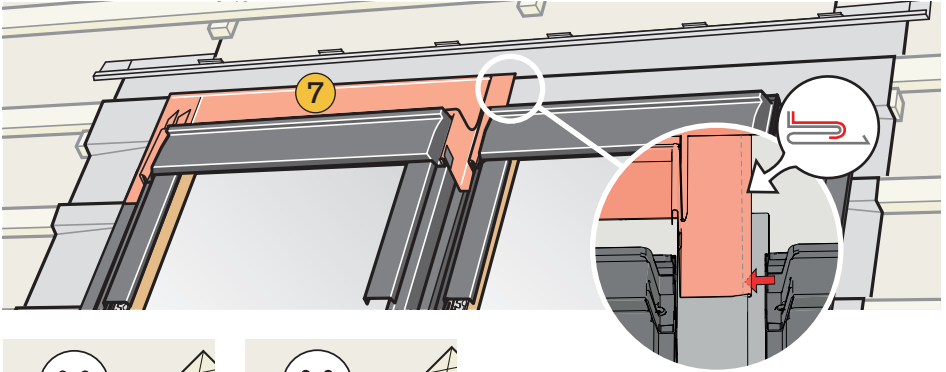

28

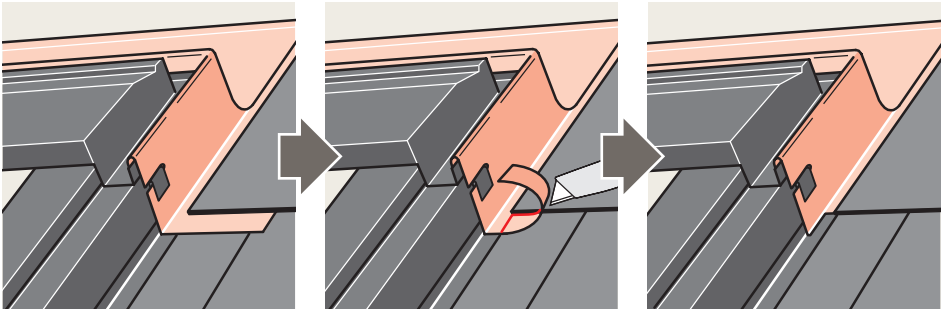



- AR:** VELUX Export (VELUX A/S)  
+ 45 4516 7885
- AT:** VELUX Österreich GmbH  
02245/32 3 50
- AU:** VELUX Australia Pty. Ltd.  
1300 859 856
- BA:** VELUX Bosna i Hercegovina d.o.o.  
033/626 493, 626 494
- BE:** VELUX Belgium  
(010) 42.09.09
- BG:** ВЕЛУКС България ЕООД  
02/955 99 30
- CA:** VELUX Canada Inc.  
1 800 88-VELUX (888-3589)
- CH:** VELUX Schweiz AG  
062 289 44 45
- CL:** VELUX Export (VELUX A/S)  
+ 45 4516 7885
- CN:** VELUX (CHINA) CO. LTD.  
0316-607 27 27
- CZ:** VELUX Česká republika, s.r.o.  
531 015 511
- DE:** VELUX Deutschland GmbH  
www.velux.de/kontakt
- DK:** VELUX Danmark A/S  
45 16 45 16
- EE:** VELUX Eesti OÜ  
621 7790
- ES:** VELUX Spain, S.A.U.  
91 509 71 00
- FR:** VELUX France  
0806 80 15 15  
Service gratuit + prix appel
- GB:** VELUX Company Ltd.  
01592 778 225
- HR:** VELUX Hrvatska d.o.o.  
01/5555 444
- HU:** VELUX Magyarország Kft.  
(06/1) 436-0601
- IE:** VELUX Company Ltd.  
01 848 8775
- IT:** VELUX Italia s.p.a.  
045/6173666
- JP:** VELUX-Japan Ltd.  
0570-00-8141
- KR:** VELUX Export (VELUX A/S)  
+ 45 4516 7885
- LT:** VELUX Lietuva, UAB  
(85) 270 91 01
- LV:** VELUX Latvia SIA  
67 27 77 33
- NL:** VELUX Nederland B.V.  
030 - 6 629 629
- NO:** VELUX Norge AS  
22 51 06 00
- NZ:** VELUX New Zealand Ltd.  
0800 650 445
- PL:** VELUX Polska Sp. z o.o.  
(022) 33 77 000 / 33 77 070
- PT:** VELUX Portugal, Lda  
21 880 00 60
- RO:** VELUX România S.R.L.  
0268-402740
- RS:** VELUX Srbija d.o.o.  
011 20 57 500
- SE:** VELUX Svenska AB  
042/20 83 80
- SI:** VELUX Slovenija d.o.o.  
01 724 68 68
- SK:** VELUX Slovensko, s.r.o.  
(02) 33 000 555
- TR:** VELUX Çatı Pencereleri  
Ticaret Limited Şirketi  
0 216 302 54 10
- UA:** ТОВ "ВЕЛІУКС Україна"  
(044) 2916070
- US:** VELUX America LLC  
1-800-88-VELUX