

VELUX®

VELUX ELECTRIC DML/RML

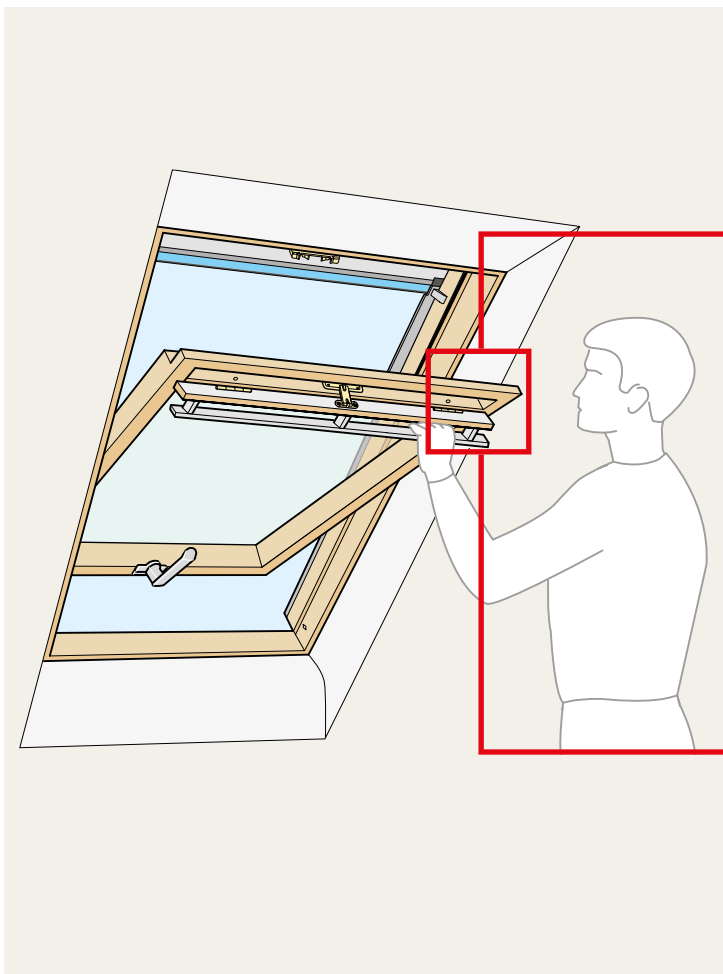



INTEGRA®



PAGES
4-17



PAGES
18-35

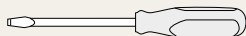
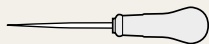
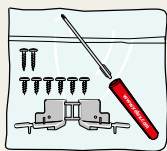
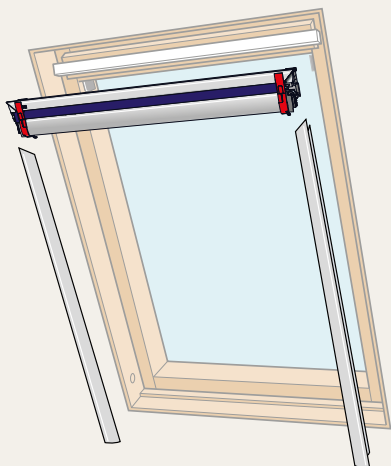

1

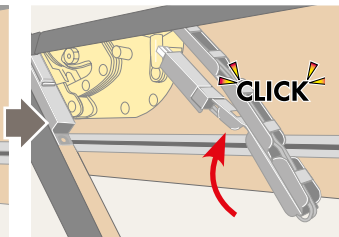
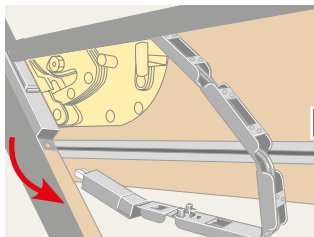
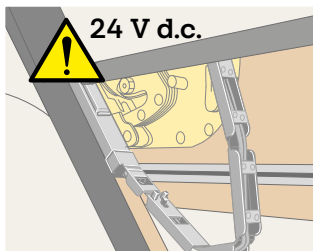
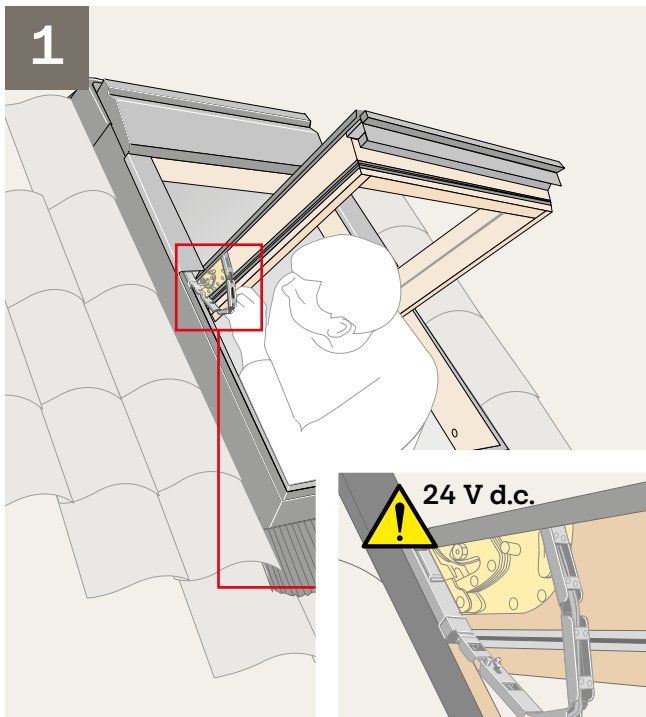

2

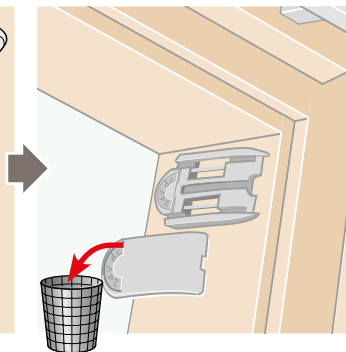
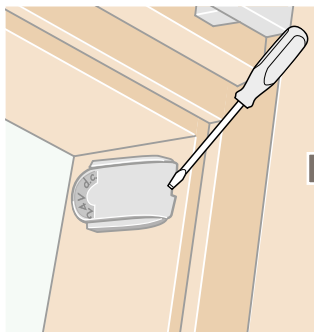
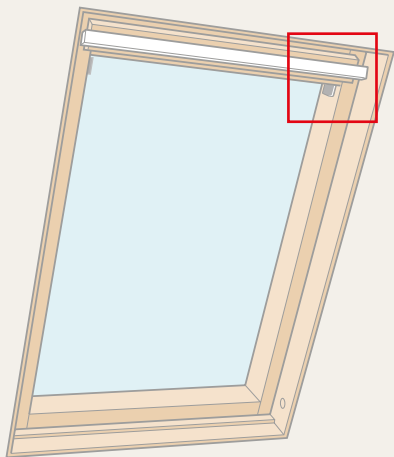

3

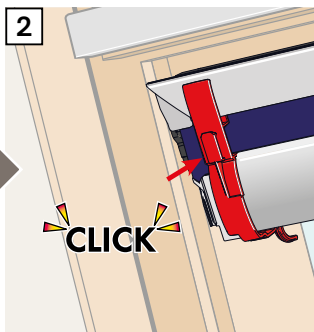
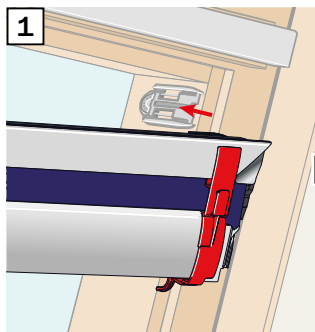
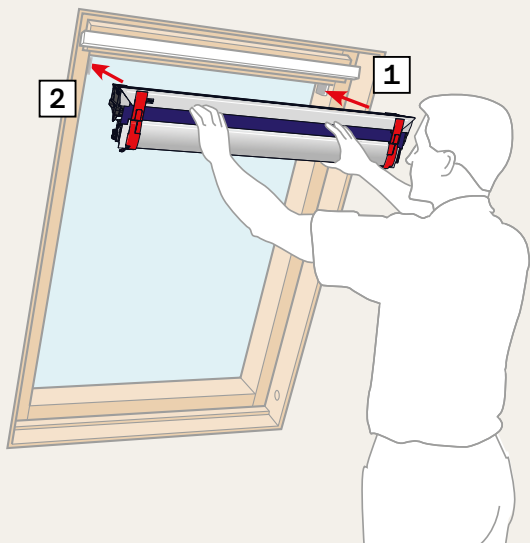

4

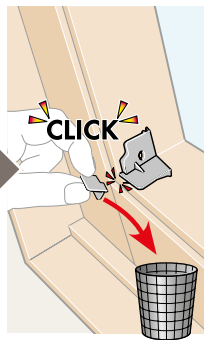
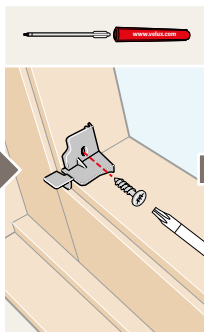
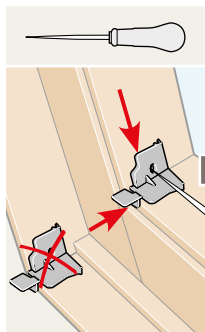
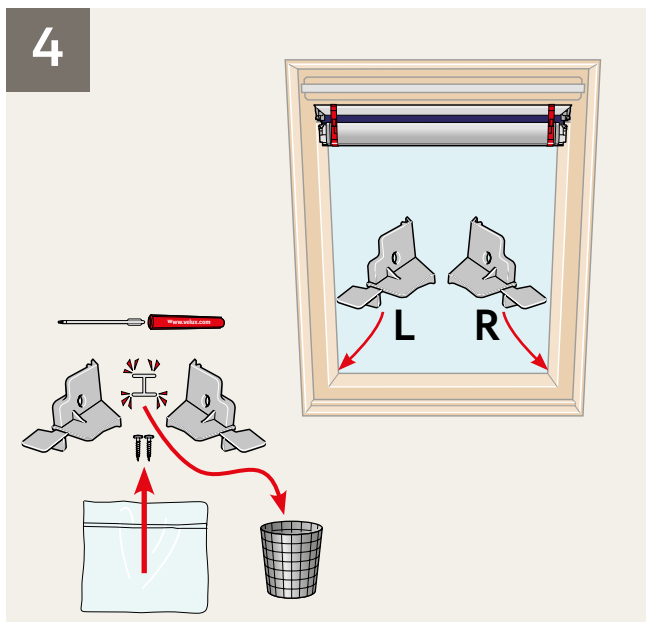

5

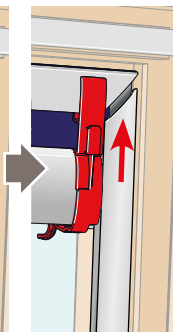
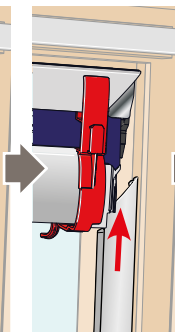
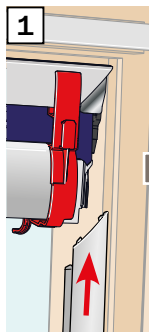
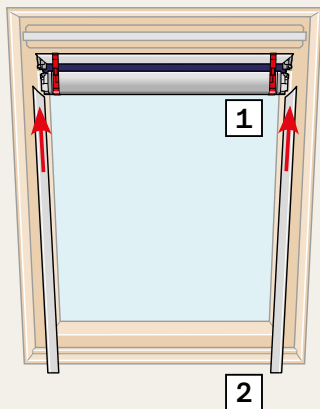
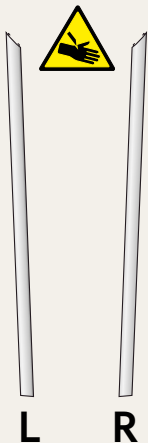

6

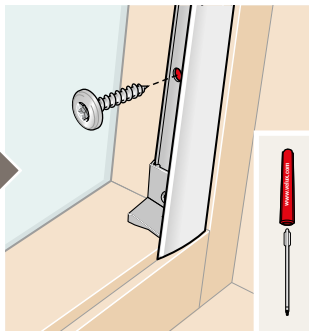
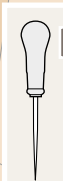
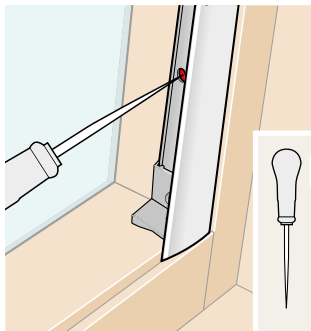
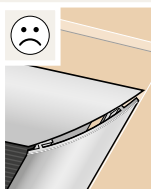
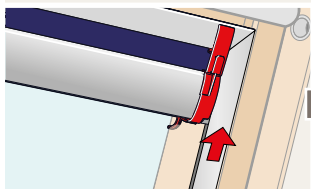
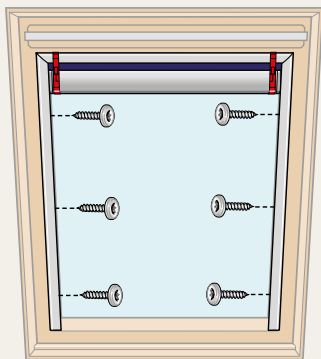
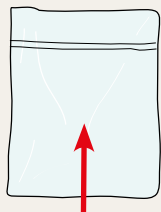

7

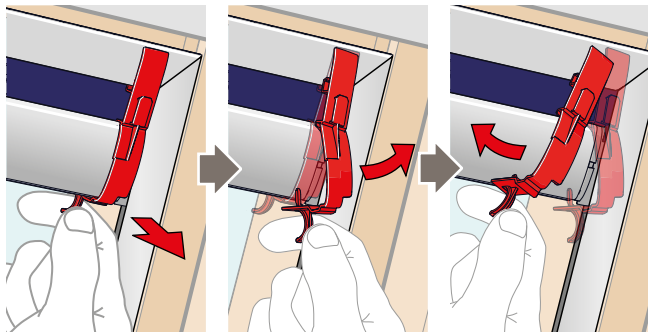
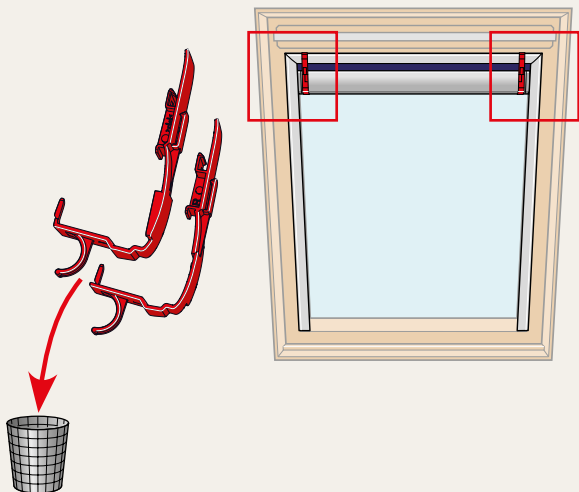

8

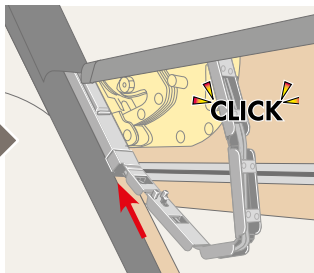
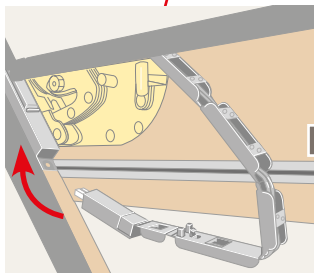
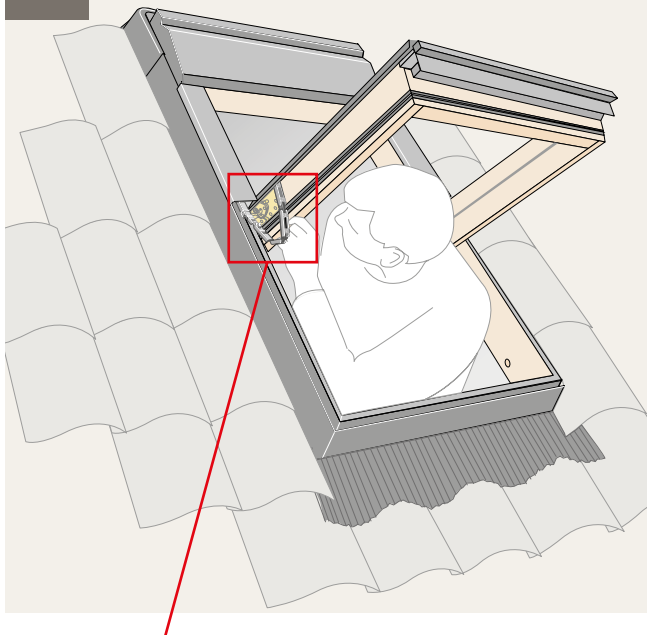

9

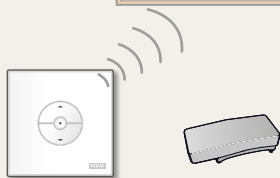
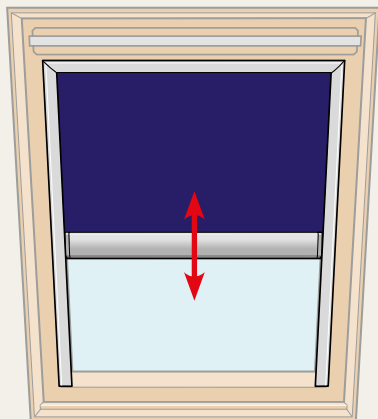

www.velux.com/electricalsupport

10

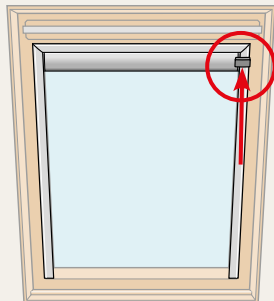
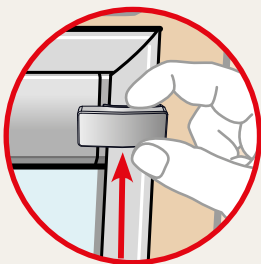
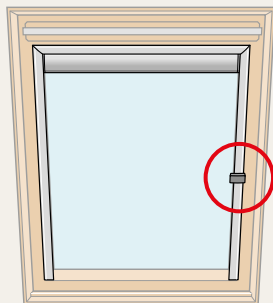
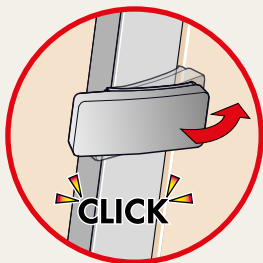
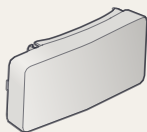

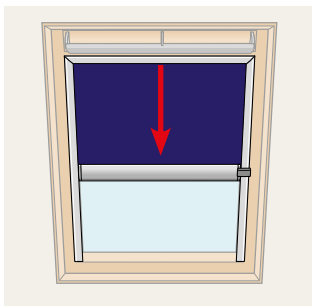
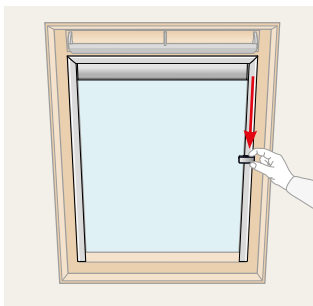
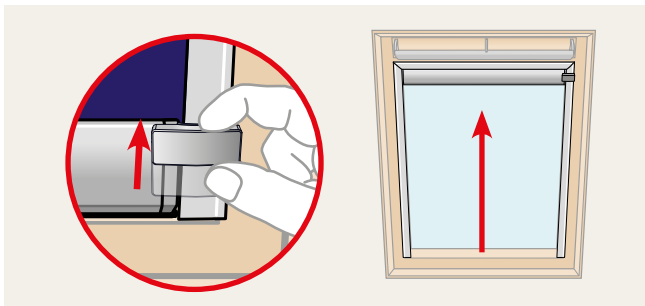
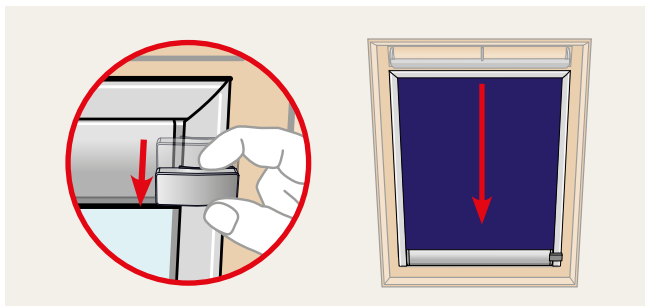

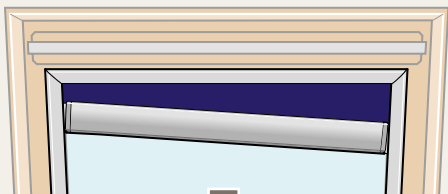
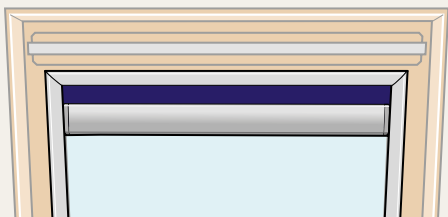



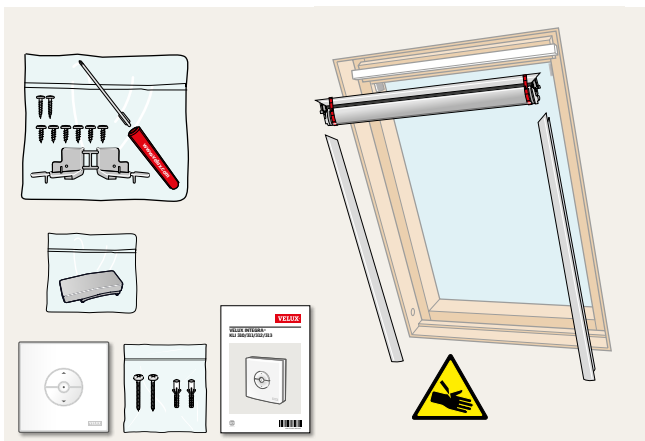

ZOZ 243

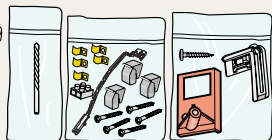

ZOZ 244

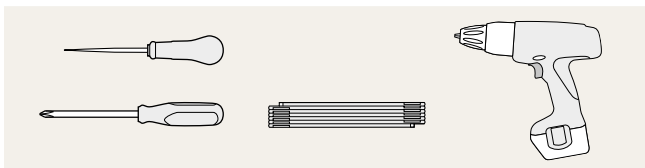
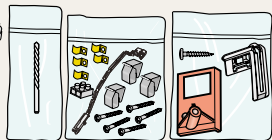

1

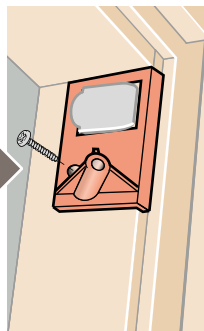
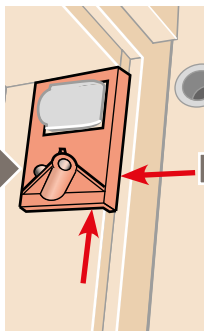
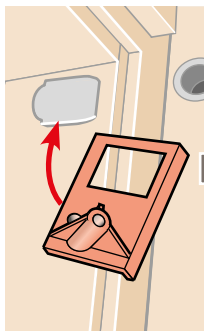
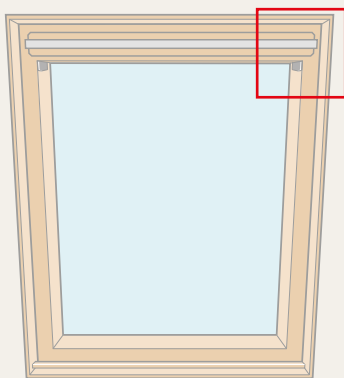
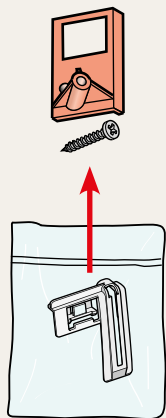

2

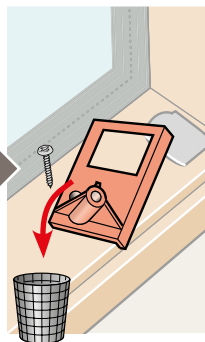
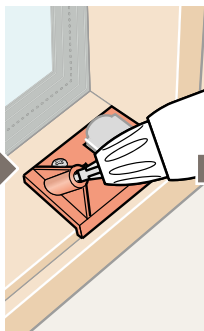
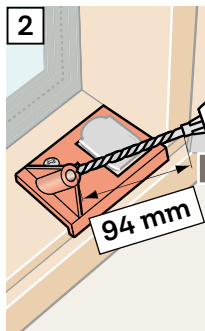
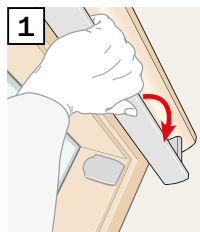
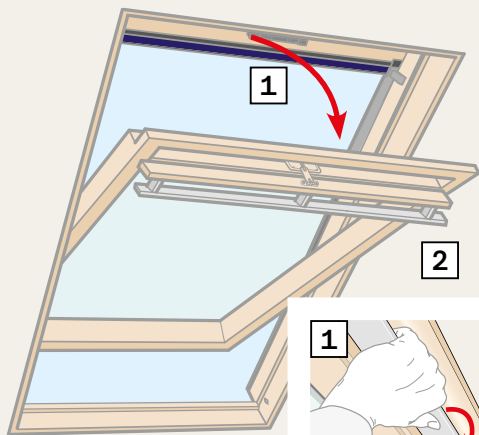
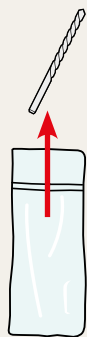

3

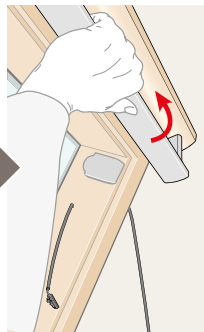
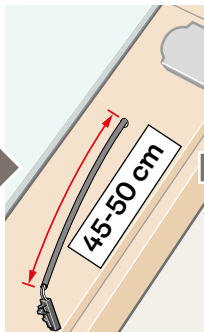
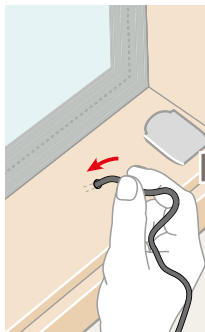
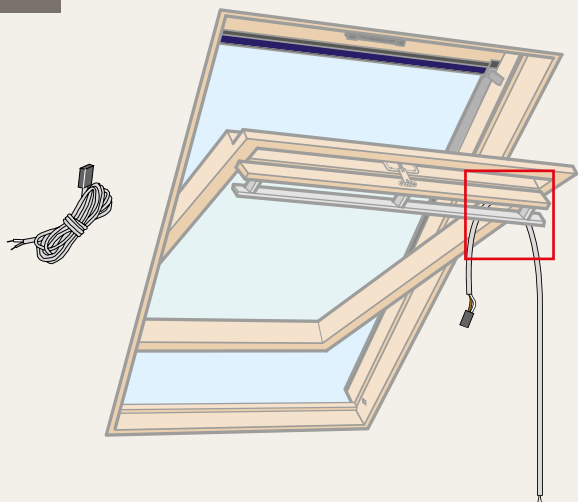

4

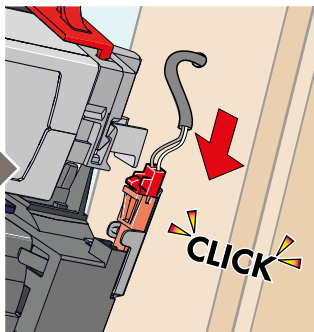
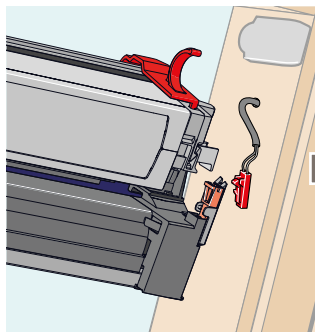
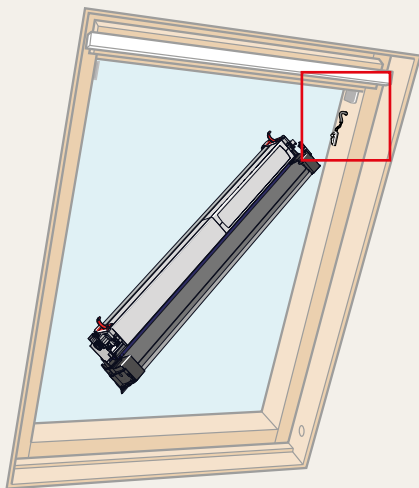

5

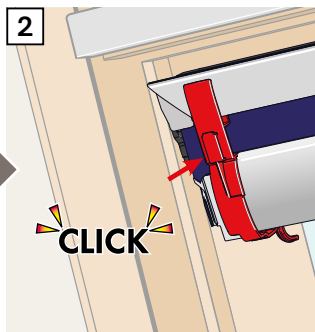
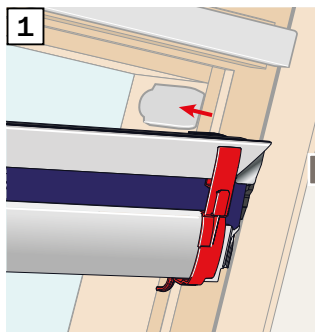
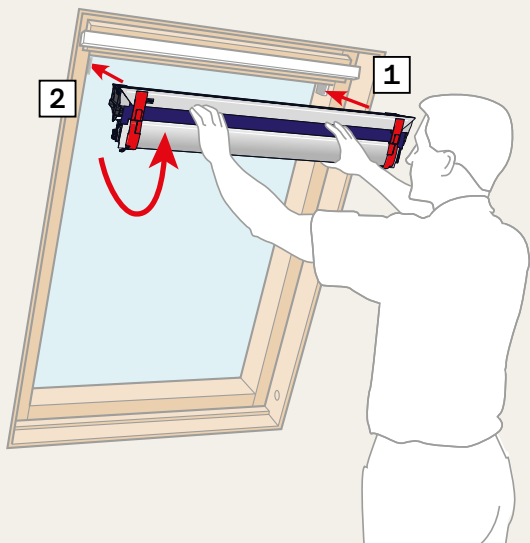

6

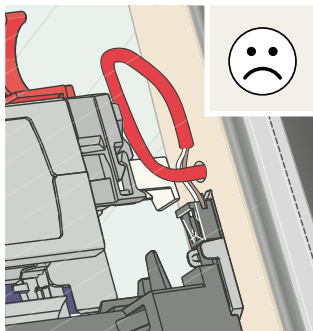
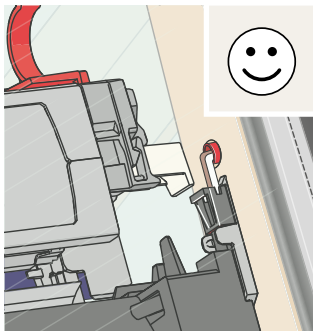
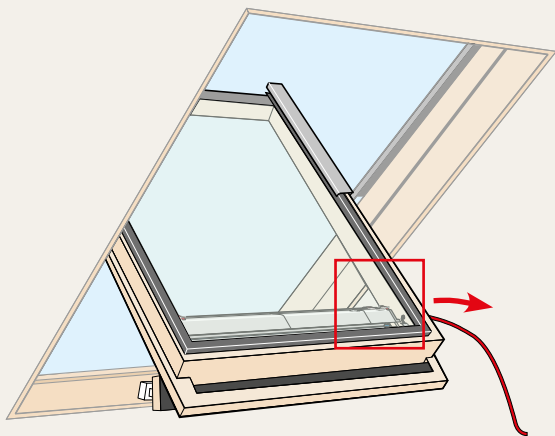

7

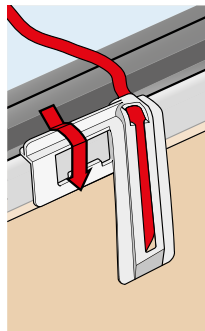
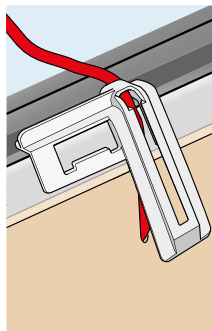
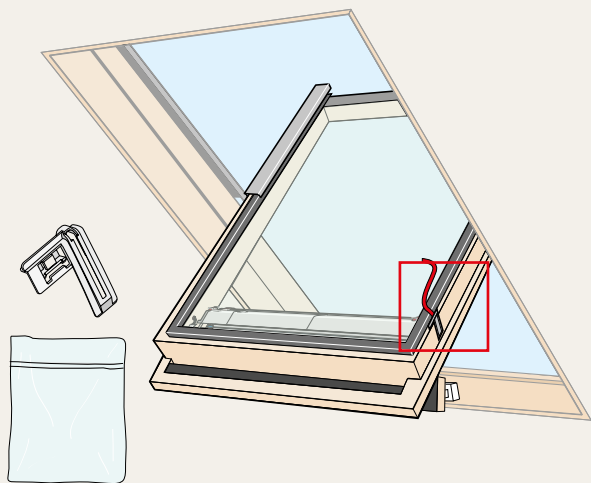

8

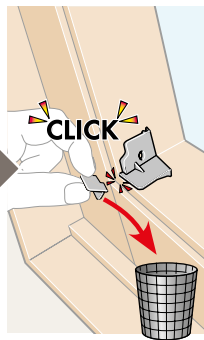
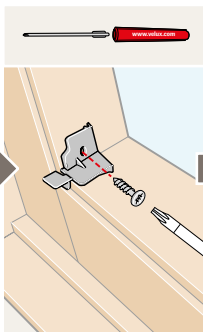
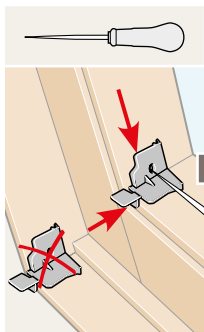
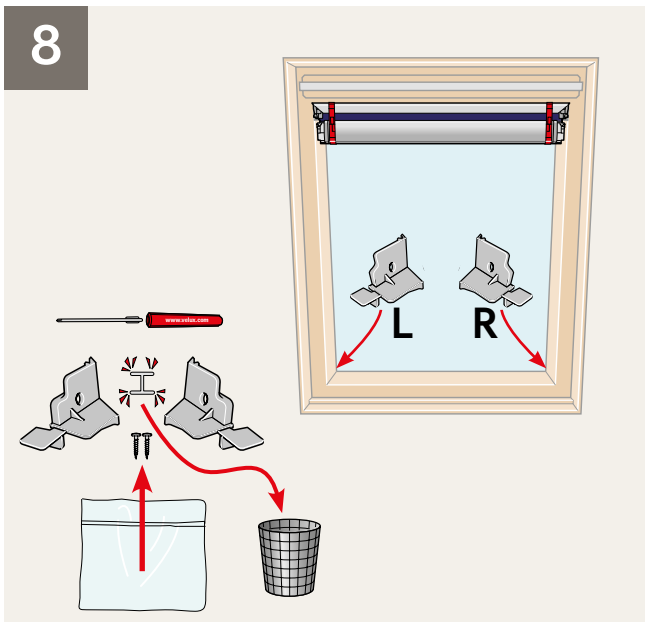

9

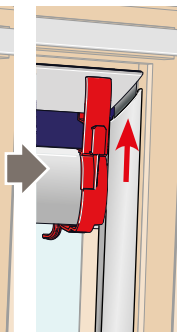
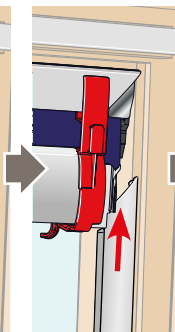
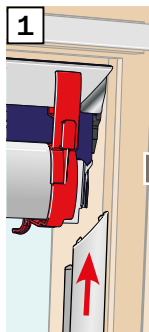
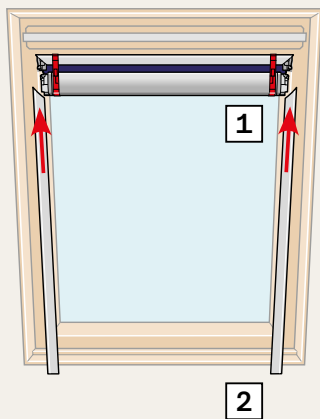
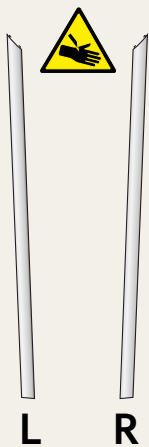

10

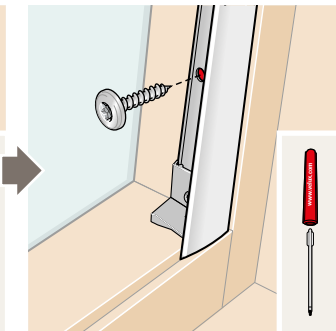
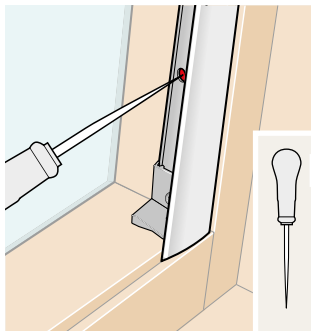
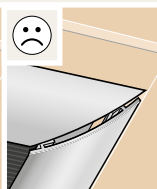
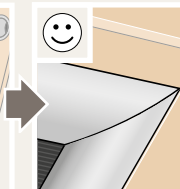
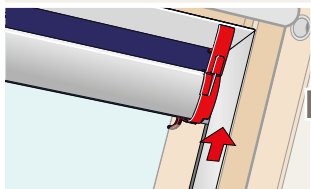
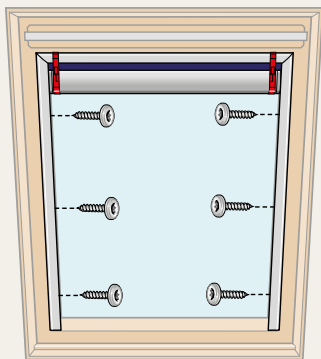
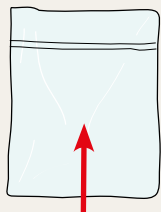

11

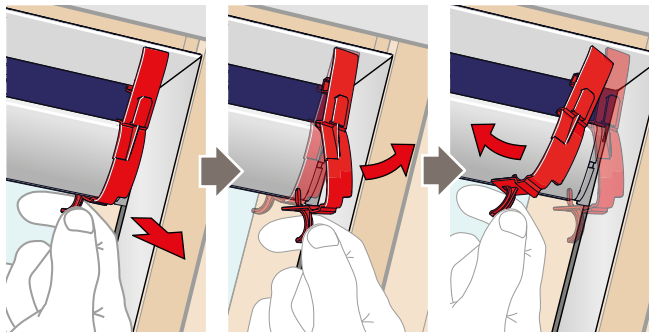
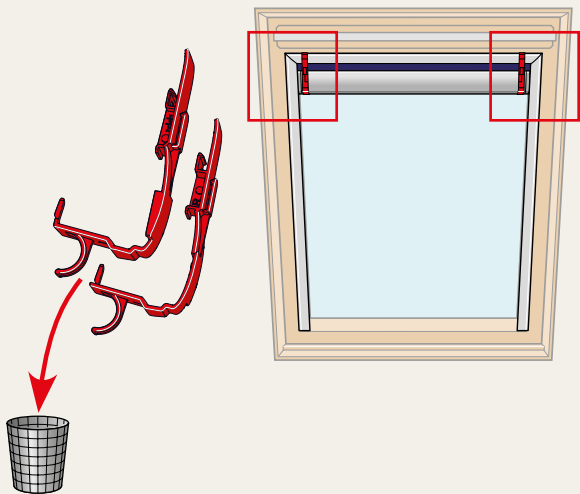

12

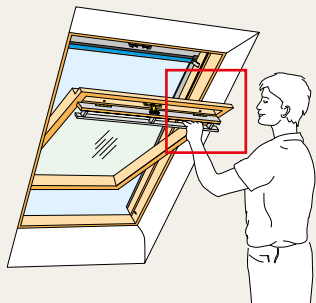

B04
C01·C02·C04·C06
F04·F06·F08
M04·M06·M08·M10·M12
P25·P04·P06·P08·P10
S01·S06·S08·S10
U04·U08·U10
X99

064
101·102·104
204·206
325·304·306
308·310·312
425·404·406·408·410
601·606·608·610
804·808·810
1·2·3·4·5·6·7·8·9
10·11·13·14·31·999

13

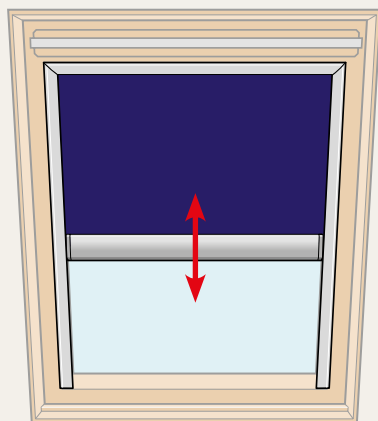

www.velux.com/electricalsupport

14

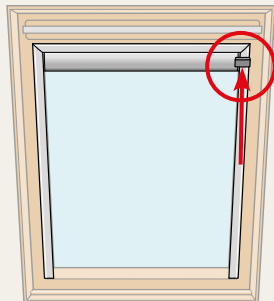
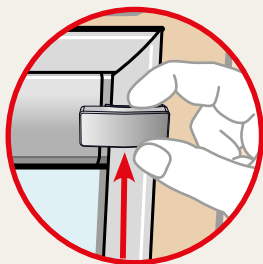
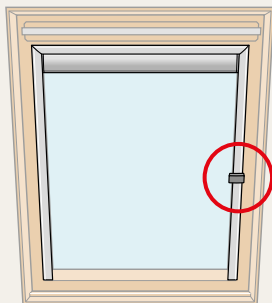
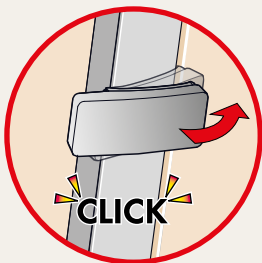
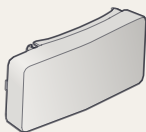

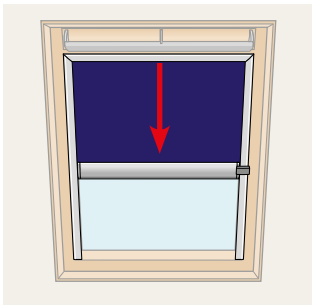
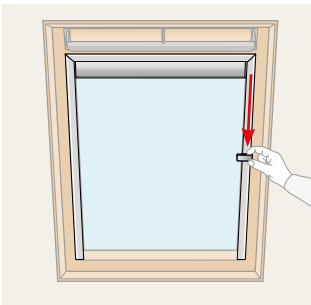
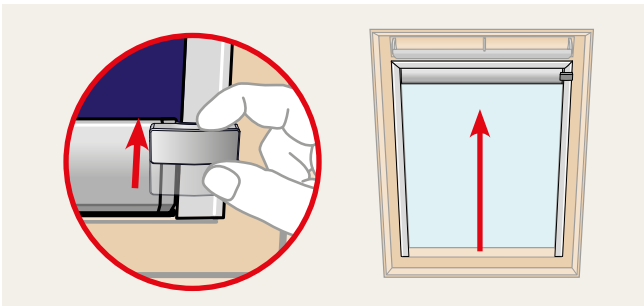
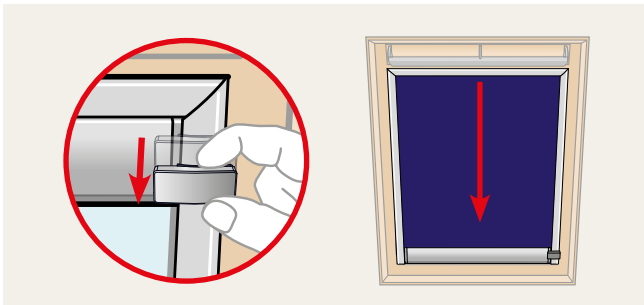

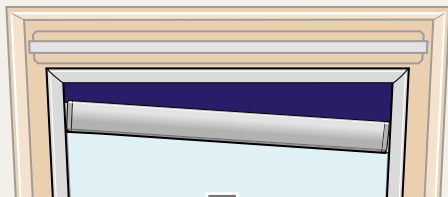
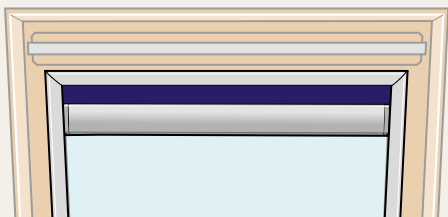

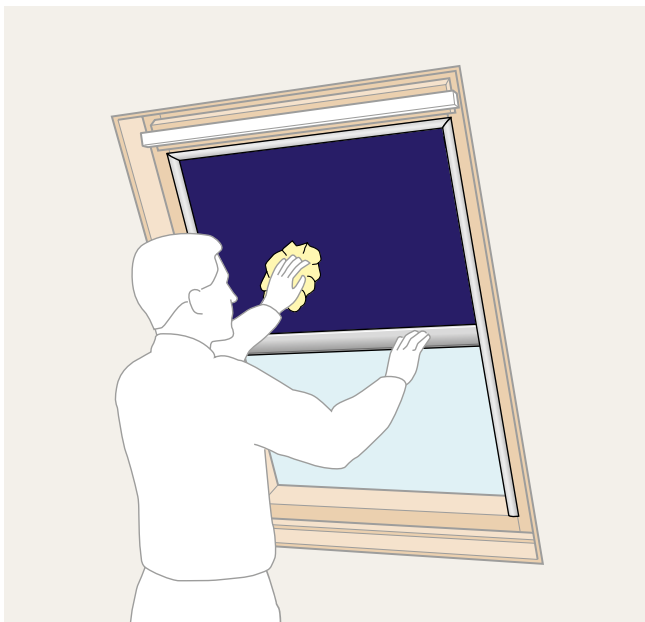

**VELUX®**

AR: VELUX Export (VELUX A/S) + 45 4516 7885	IT: VELUX Italia s.p.a. 045/6173666
AT: VELUX Österreich GmbH 02245/32 3 50	JP: VELUX-Japan Ltd. 0570-00-8141
AU: VELUX Australia Pty. Ltd. 1300 859 856	KR: VELUX Export (VELUX A/S) + 45 4516 7885
BA: VELUX Bosna i Hercegovina d.o.o. 033/626 493, 626 494	LT: VELUX Lietuva, UAB (85) 270 91 01
BE: VELUX Belgium (010) 42.09.09	LV: VELUX Latvia SIA 67 27 77 33
BG: ВЕЛУКС България ЕООД 02/955 99 30	NL: VELUX Nederland B.V. 030 - 6 629 629
CA: VELUX Canada Inc. 1 800 88-VELUX (888-3589)	NO: VELUX Norge AS 22 51 06 00
CH: VELUX Schweiz AG 062 289 44 45	NZ: VELUX New Zealand Ltd. 0800 650 445
CL: VELUX Export (VELUX A/S) + 45 4516 7885	PL: VELUX Polska Sp. z o.o. (022) 33 77 000 / 33 77 070
CN: VELUX (CHINA) CO. LTD. 0316-607 27 27	PT: VELUX Portugal, Lda 21 880 00 60
CZ: VELUX Česká republika, s.r.o. 531 015 511	RO: VELUX România S.R.L. 0268-402740
DE: VELUX Deutschland GmbH www.velux.de/kontakt	RS: VELUX Srbija d.o.o. 011 20 57 500
DK: VELUX Danmark A/S 45 16 45 16	SE: VELUX Svenska AB 042/20 83 80
EE: VELUX Eesti OÜ 621 7790	SI: VELUX Slovenija d.o.o. 01 724 68 68
ES: VELUX Spain, S.A.U. 91 509 71 00	SK: VELUX Slovensko, s.r.o. (02) 33 000 555
FI: VELUX Suomi Oy 0207 290 800	TR: VELUX Çati Pencereleri Ticaret Limited Şirketi 0 216 302 54 10
FR: VELUX France 0806 80 15 15 Service gratuit + prix appel	UA: ТОВ "ВЕЛЮКС Україна" (044) 2916070
GB: VELUX Company Ltd. 01592 778 225	US: VELUX America LLC 1-800-88-VELUX
HR: VELUX Hrvatska d.o.o. 01/5555 444	
HU: VELUX Magyarország Kft. (06/1) 436-0601	
IE: VELUX Company Ltd. 01 848 8775	

www.velux.com