

# EAW/EAS/EAZ 6-21/6-31

## EAZ

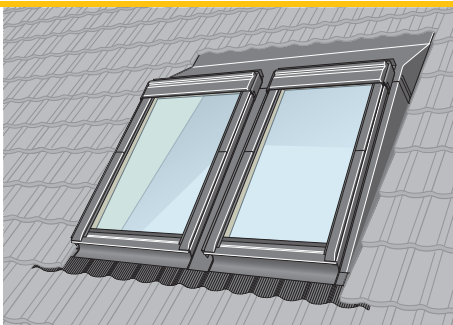
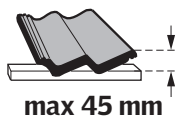

Pages 2-28  
Pages 30-37

## EAW

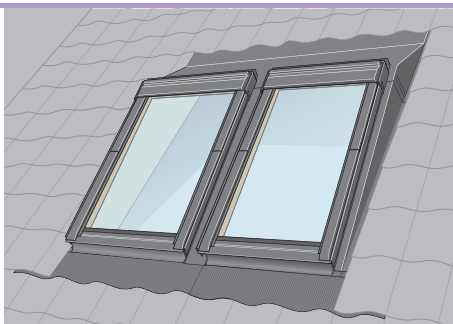
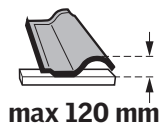

Pages 2-28  
Pages 38-45

## EAS

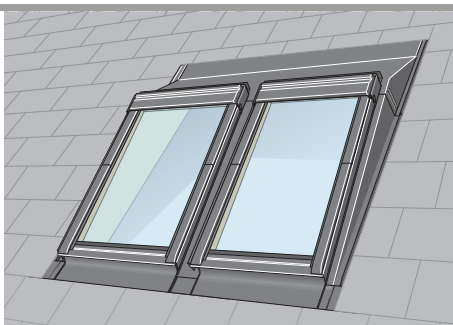
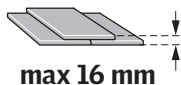

Pages 2-28  
Pages 46-51



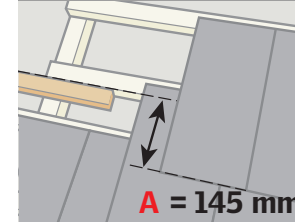
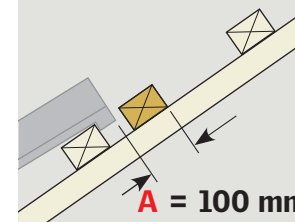
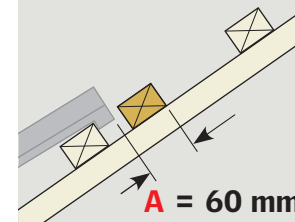
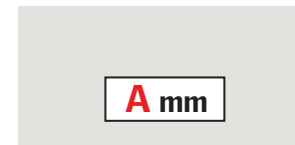
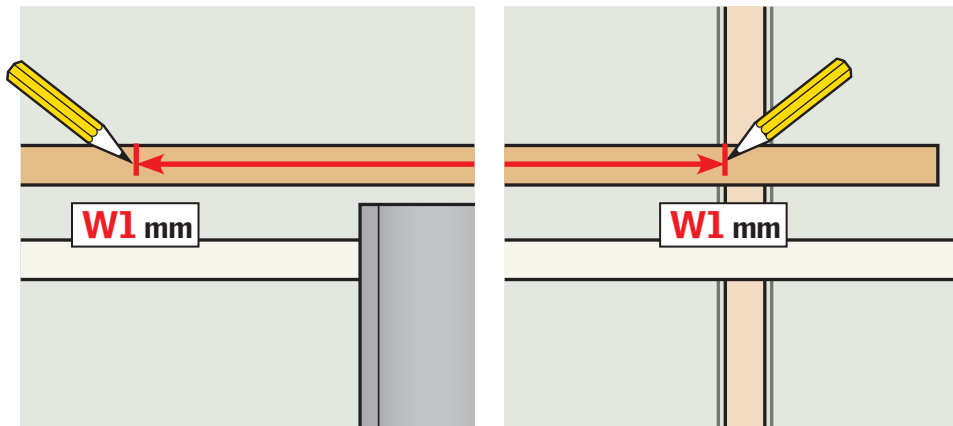
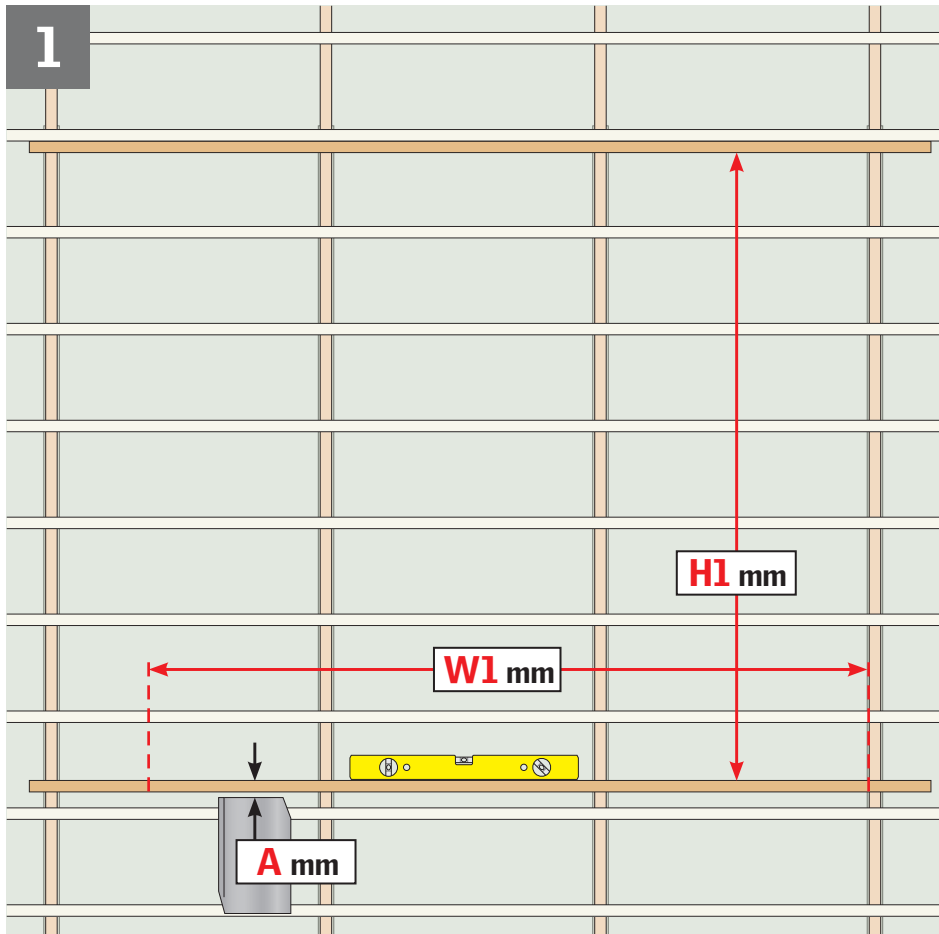



	<b>W1 mm</b>	<b>H1 mm</b>
2x FK06	1460	1880
2x FK08	1460	2180
2x MK04	1700	1610
2x MK06	1700	1880
2x MK08	1700	2180
2x MK10	1700	2455
2x PK06	2024	1880
2x PK08	2024	2180
2x PK10	2024	2455
2x SK06	2420	1880
2x SK08	2420	2180
2x SK10	2420	2455
2x UK04	2820	1610
2x UK08	2820	2180

	<b>W1 mm</b>	<b>H1 mm</b>
3x FK06	2220	1880
3x FK08	2220	2180
3x MK04	2580	1610
3x MK06	2580	1880
3x MK08	2580	2180
3x MK10	2580	2455

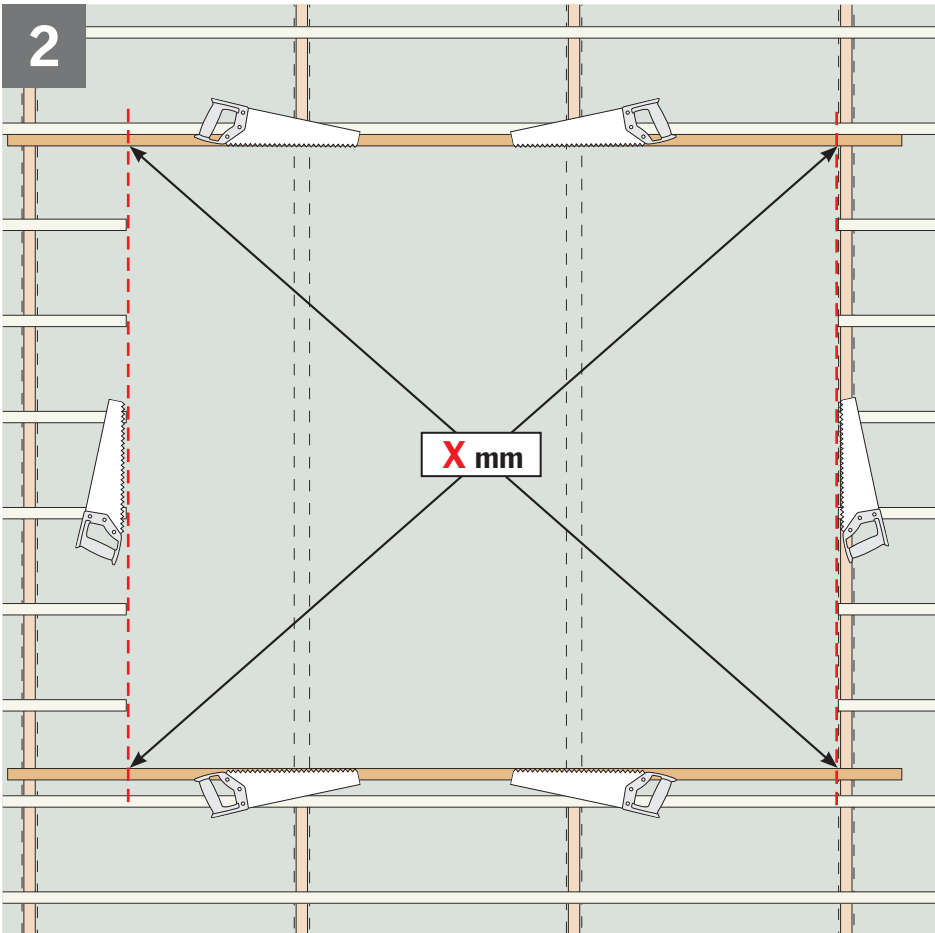



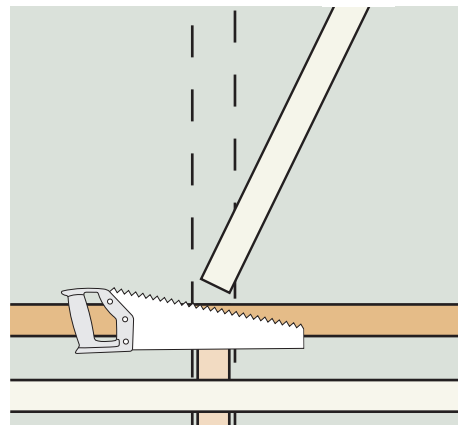
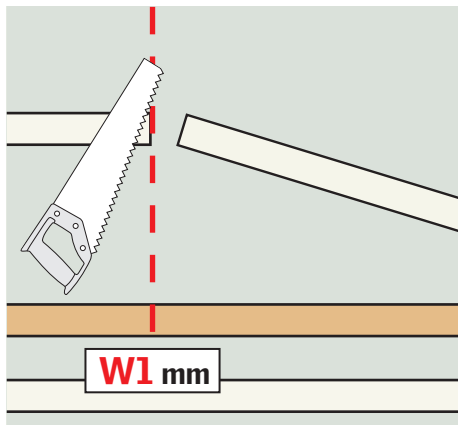

	<b>X mm</b>
2x FK06	2380
2x FK08	2624
2x MK04	2341
2x MK06	2534
2x MK08	2764
2x MK10	2986
2x PK06	2762
2x PK08	2975
2x PK10	3182
2x SK06	3064
2x SK08	3257
2x SK10	3447
2x UK04	3247
2x UK08	3564

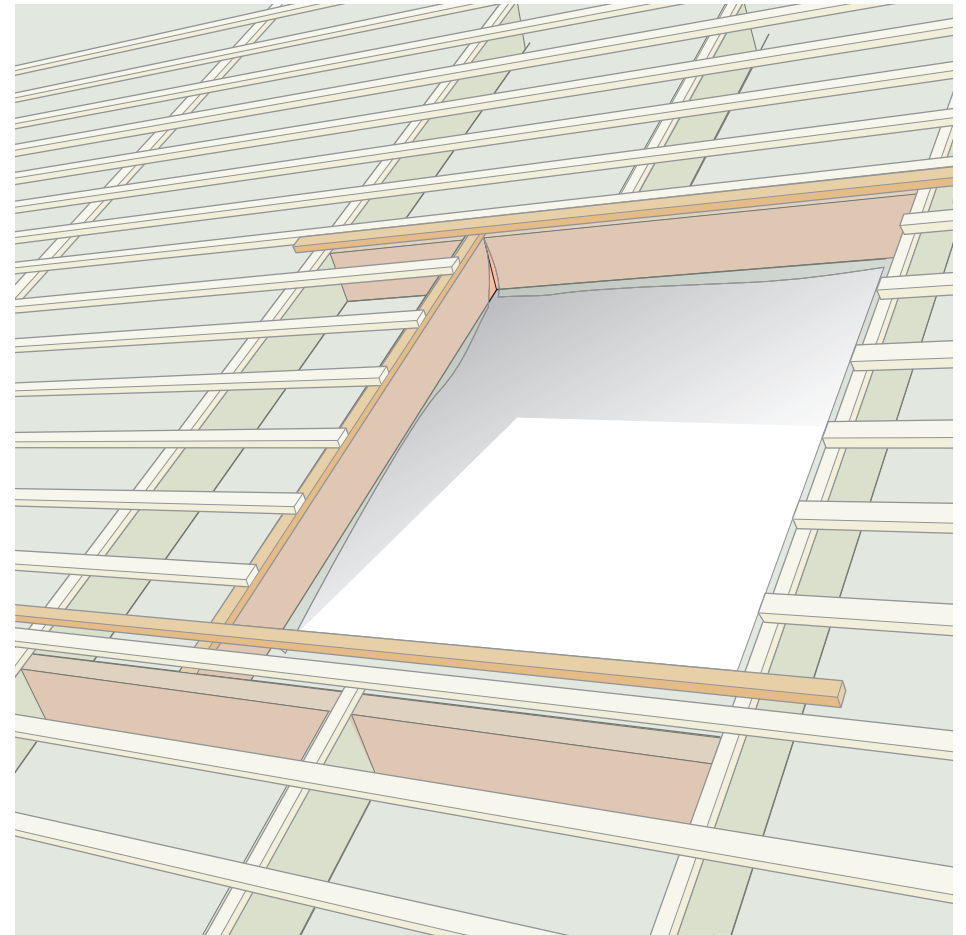
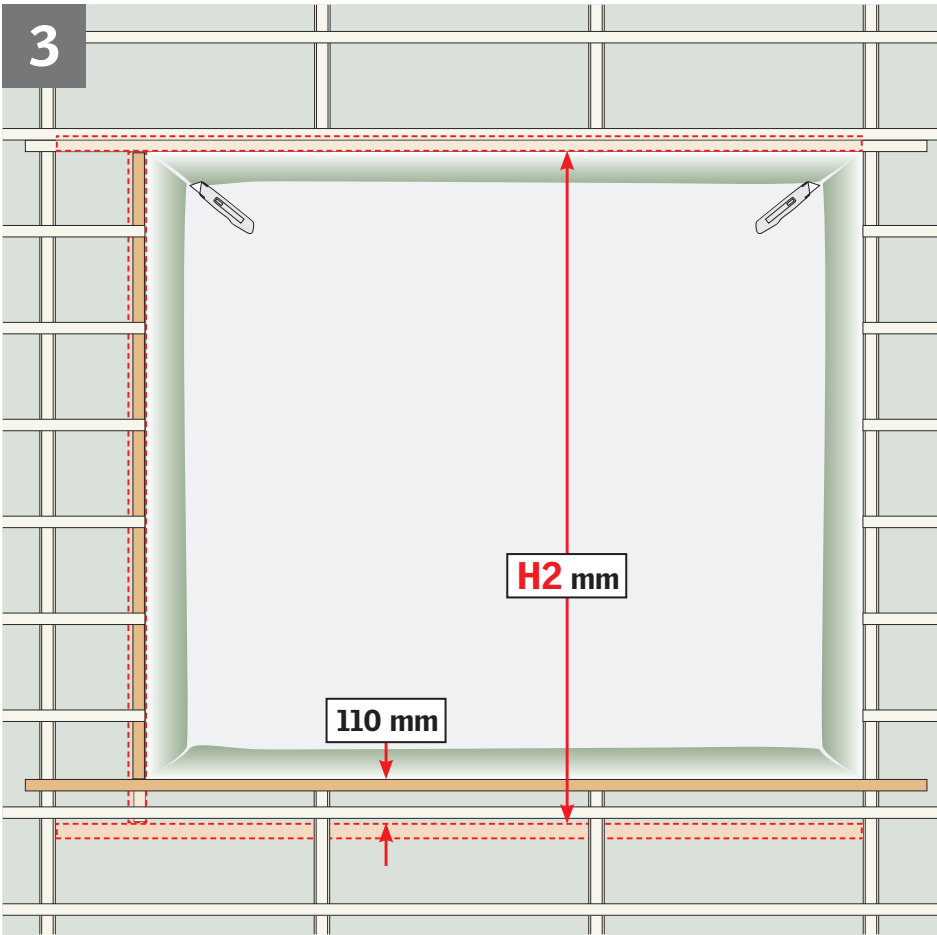

	<b>X mm</b>
3x FK06	2909
3x FK08	3111
3x MK04	3041
3x MK06	3192
3x MK08	3378
3x MK10	3561



	<b>H2 mm</b>
-K04	1720
-K06	1990
-K08	2290
-K10	2565

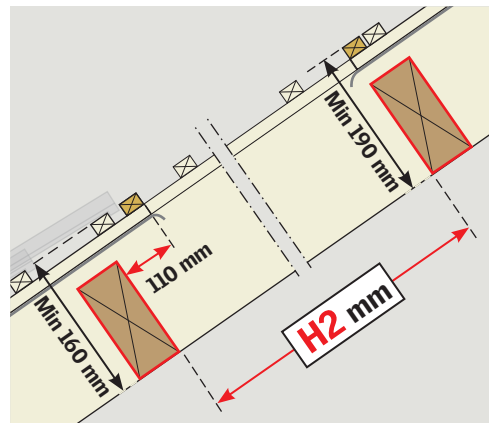

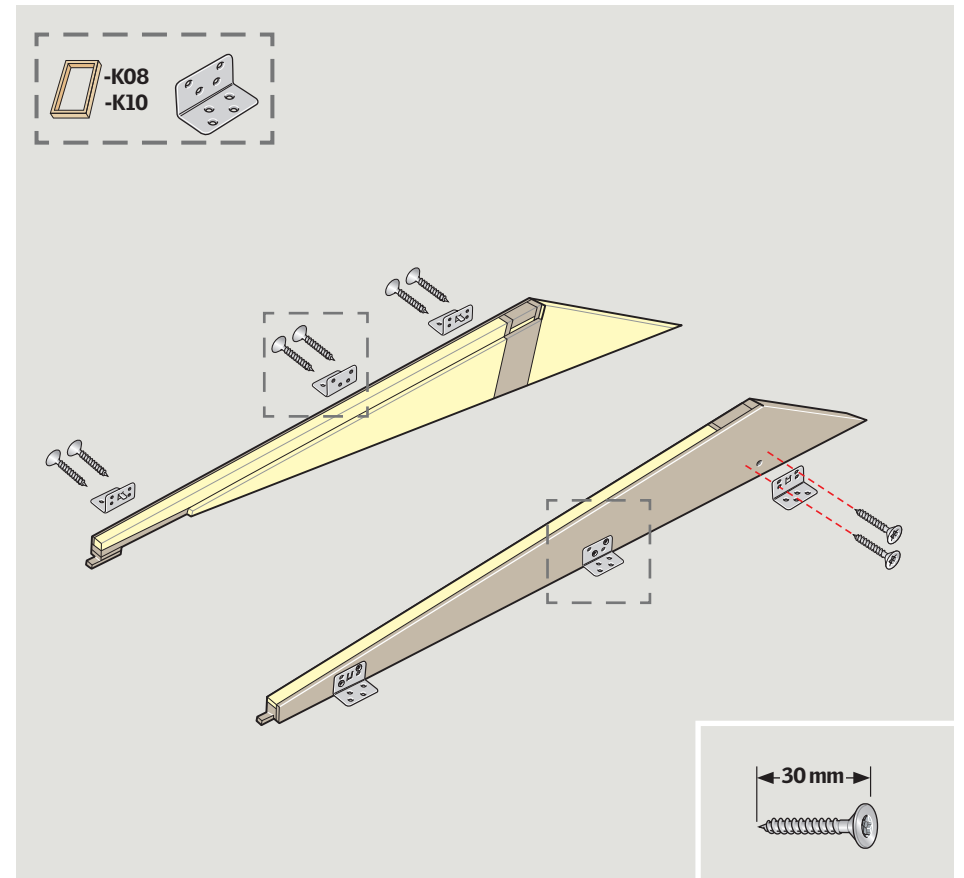
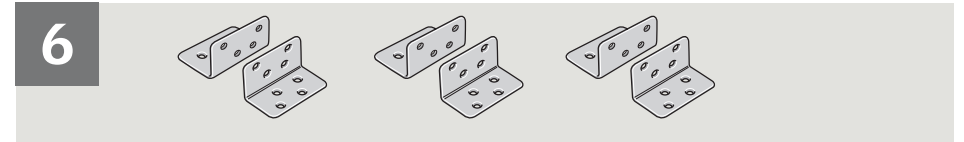
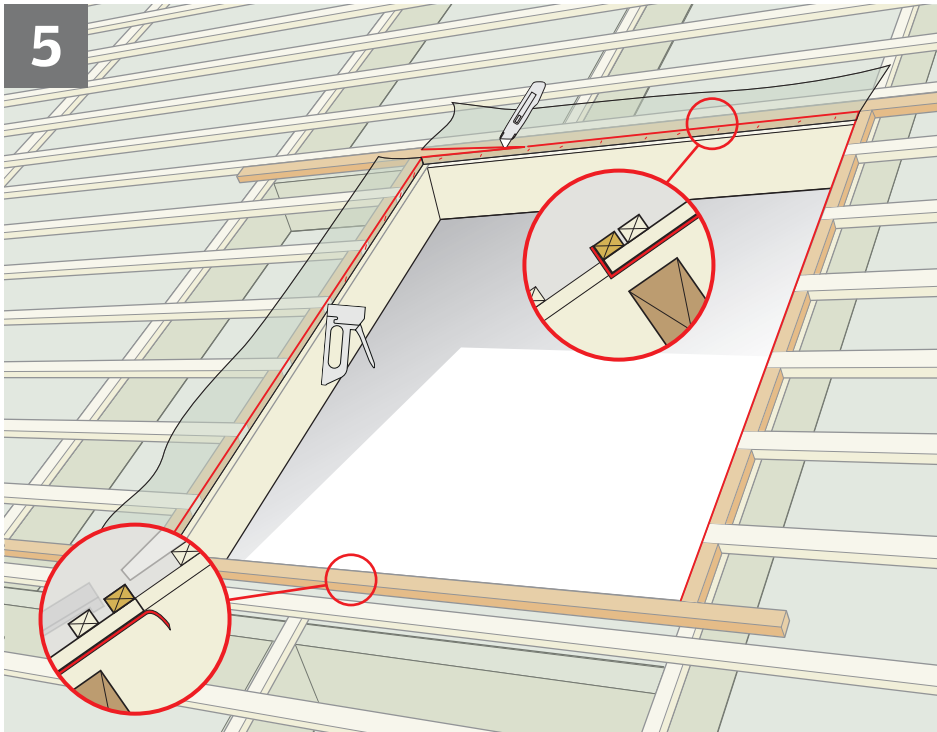
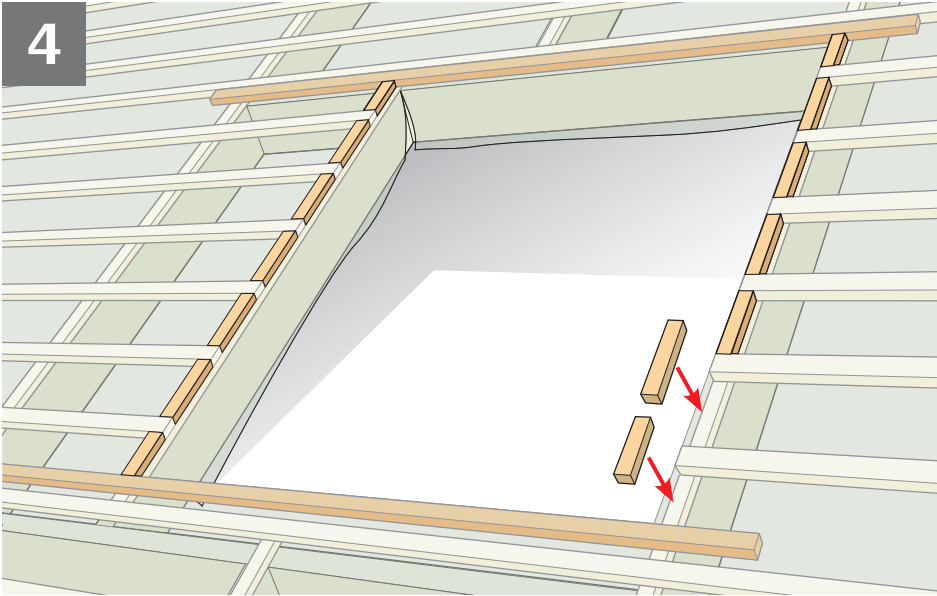

7

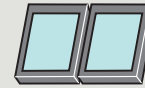
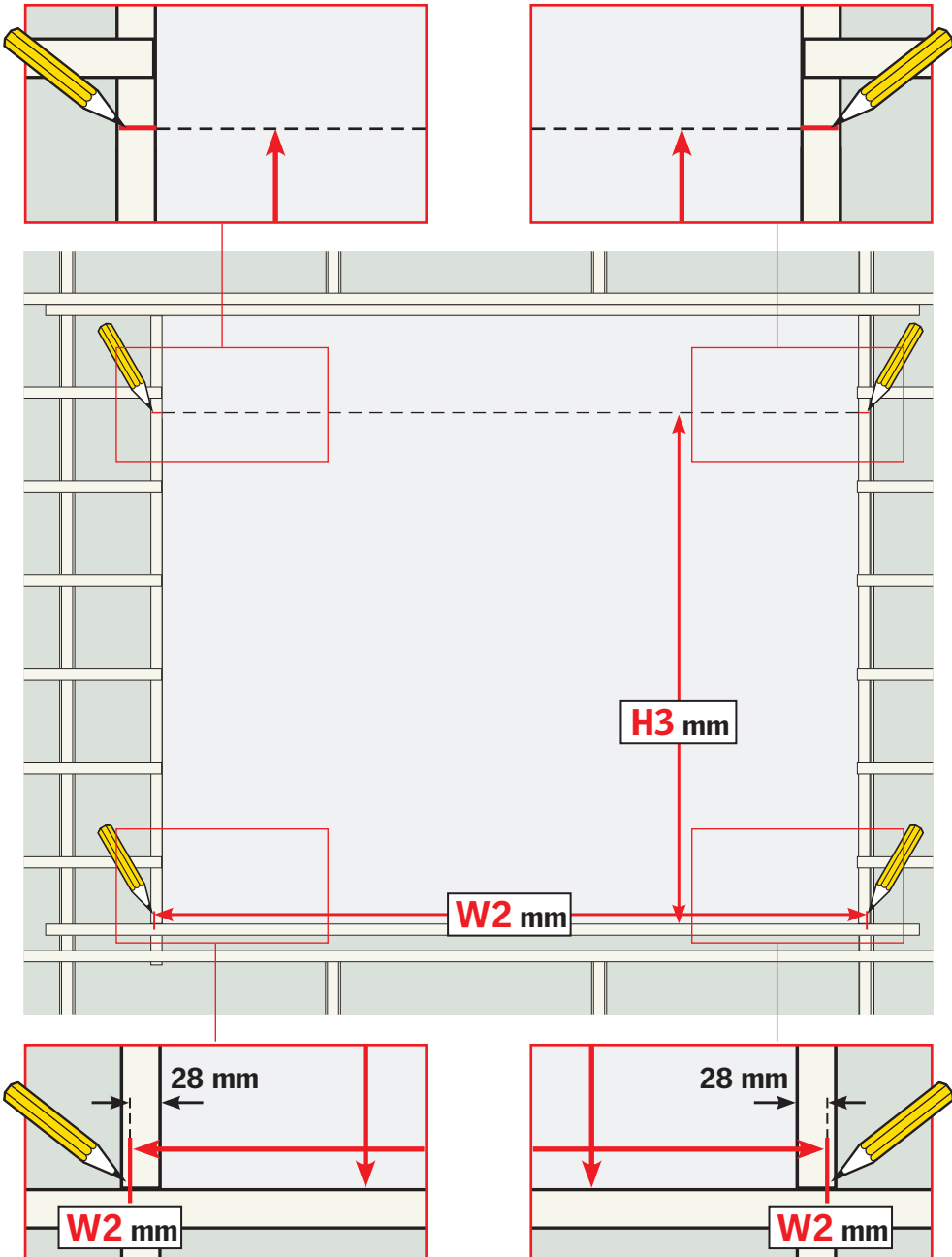
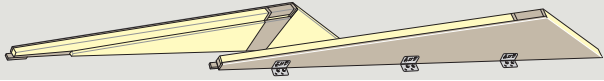

**W2 mm**

**H3 mm**

2x FK06	1516	1675
2x FK08	1516	1975
2x MK04	1756	1405
2x MK06	1756	1675
2x MK08	1756	1975
2x MK10	1756	2245
2x PK06	2080	1675
2x PK08	2080	1975
2x PK10	2080	2245
2x SK06	2476	1675
2x SK08	2476	1975
2x SK10	2476	2245
2x UK04	2876	1405
2x UK08	2876	1975



**W2 mm**

**H3 mm**

3x FK06	2276	1675
3x FK08	2276	1975
3x MK04	2636	1405
3x MK06	2636	1675
3x MK08	2636	1975
3x MK10	2636	2245

8

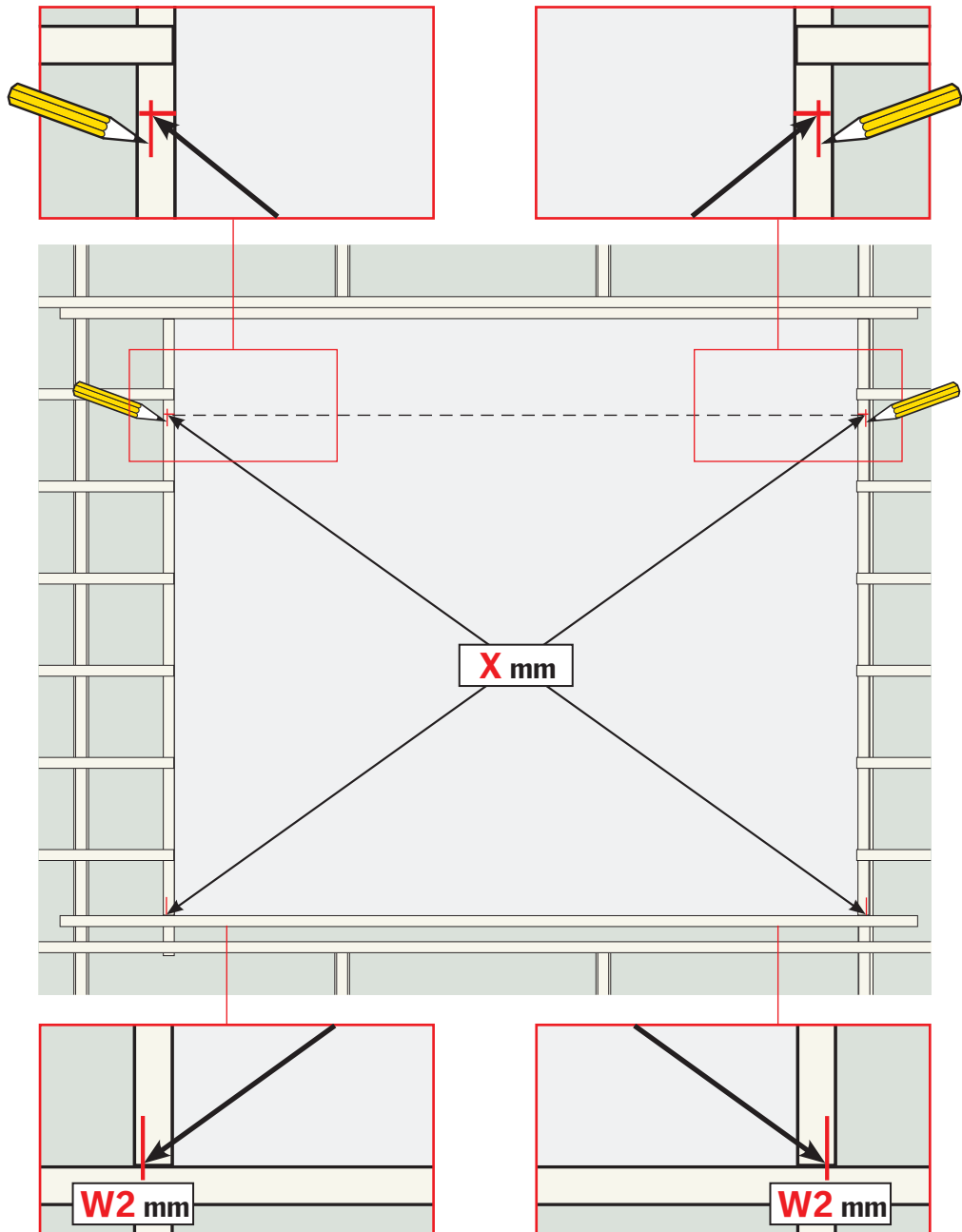
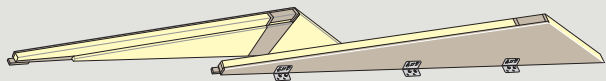

**X mm**

2x FK06	2260
2x FK08	2490
2x MK04	2249
2x MK06	2427
2x MK08	2643
2x MK10	2851
2x PK06	2671
2x PK08	2869
2x PK10	3061
2x SK06	2990
2x SK08	3168
2x SK10	3343
2x UK04	3201
2x UK08	3489



**X mm**

3x FK06	2826
3x FK08	3014
3x MK04	2988
3x MK06	3124
3x MK08	3294
3x MK10	3463

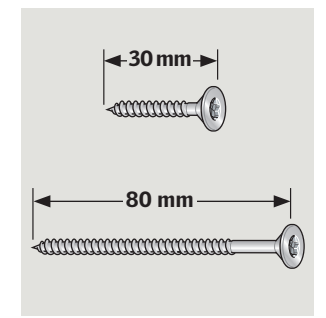
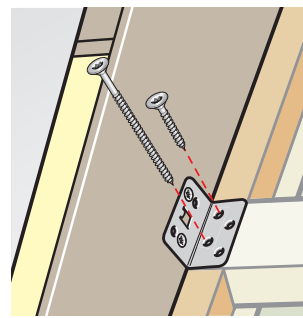
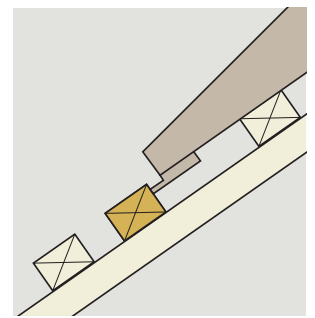
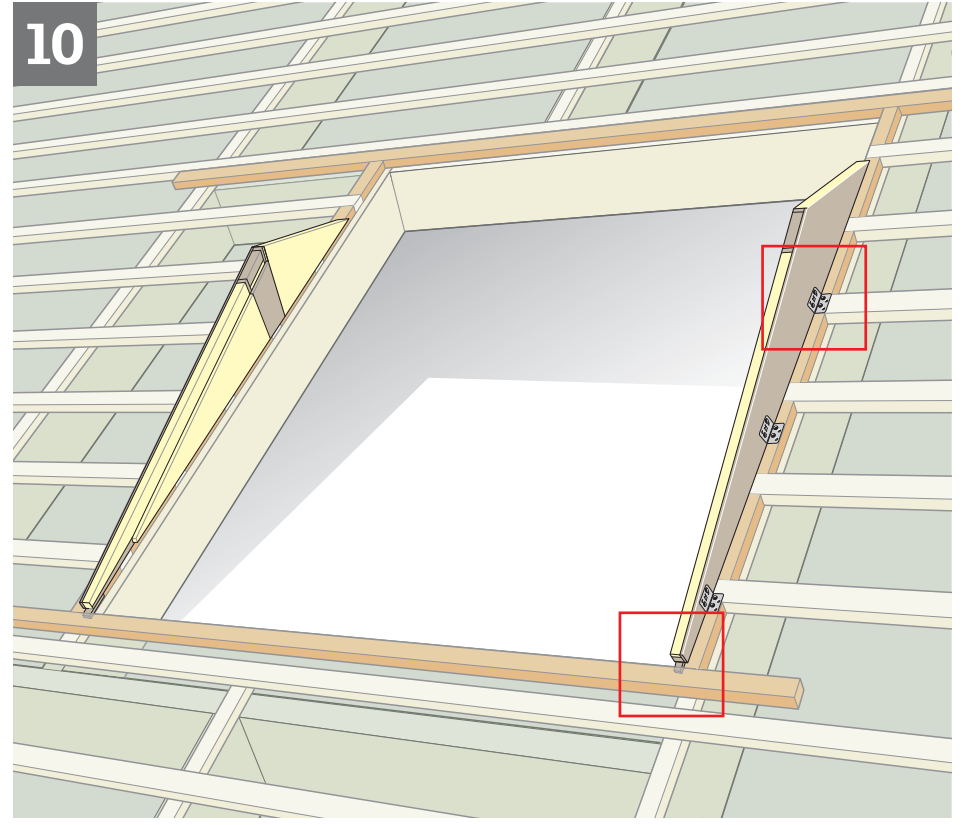
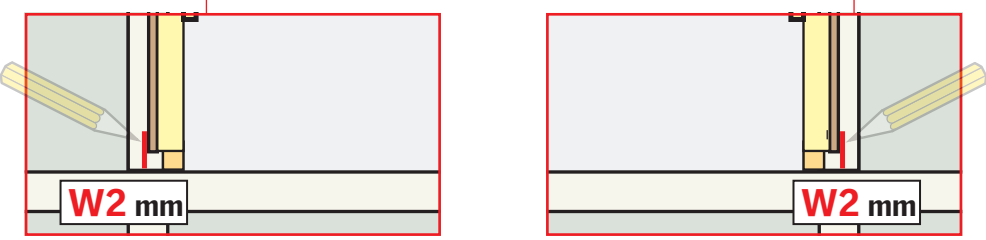
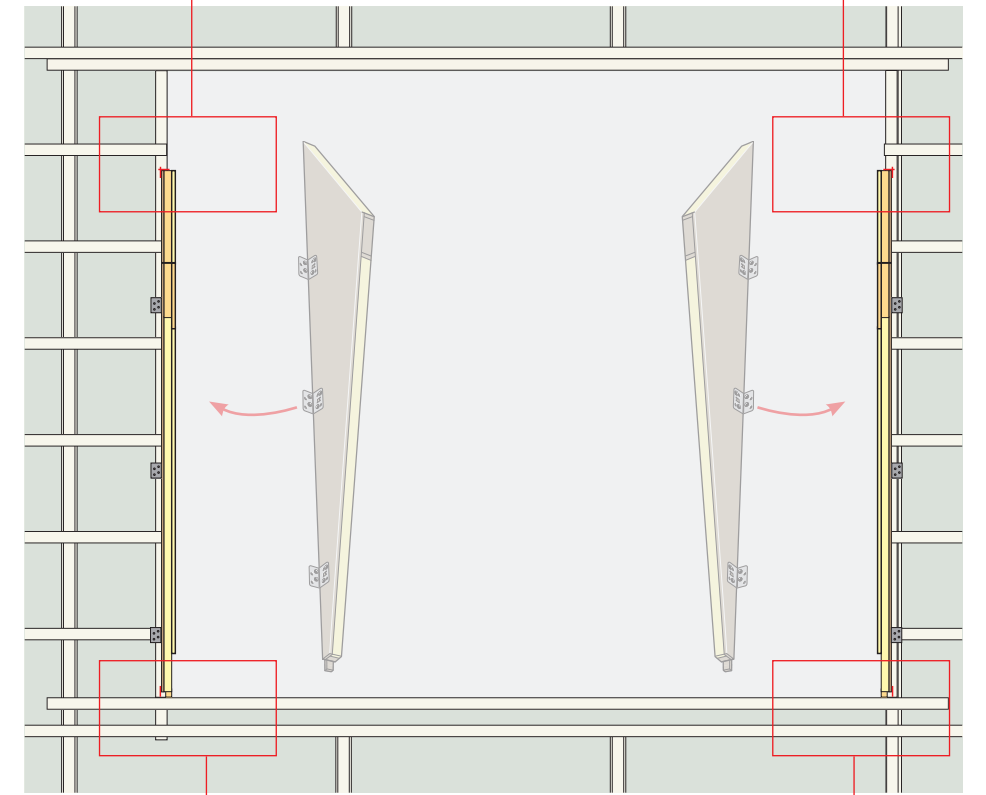
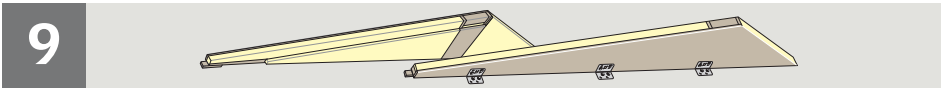

11

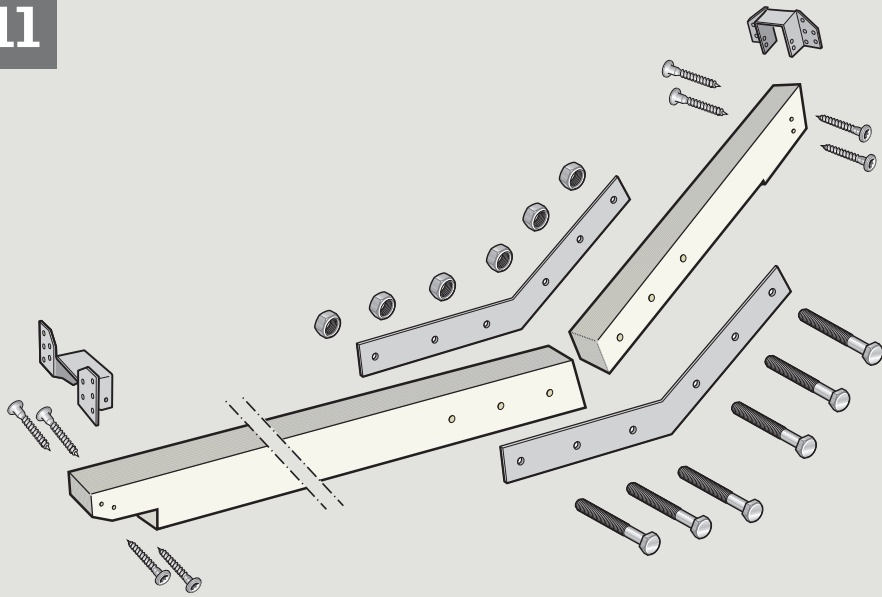

12

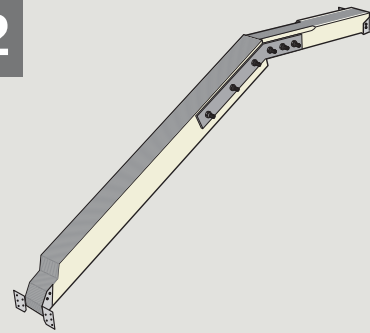

	<b>W3 mm</b>
FK--	720
MK--	840
PK--	1002
SK--	1200
UK--	1400

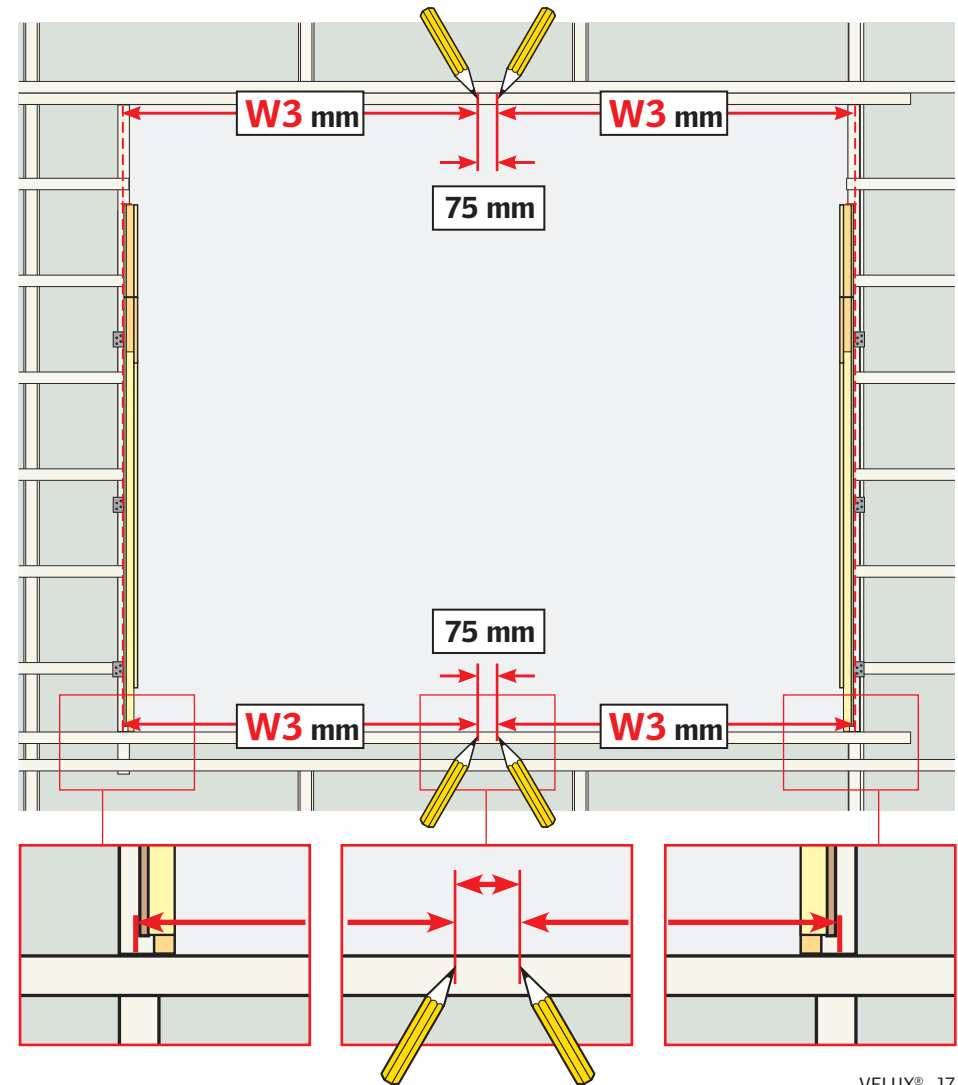
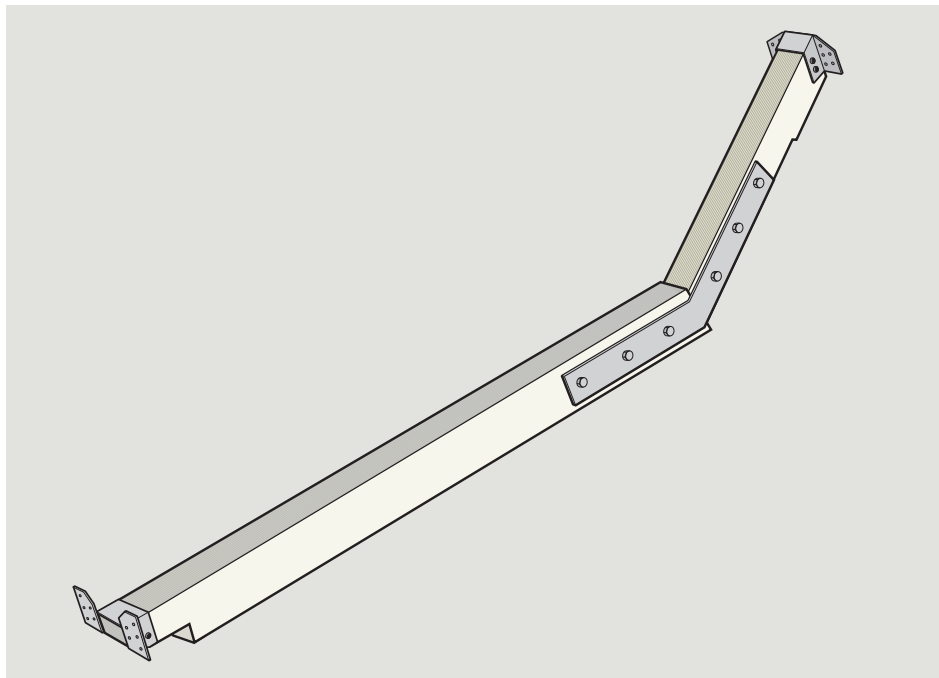

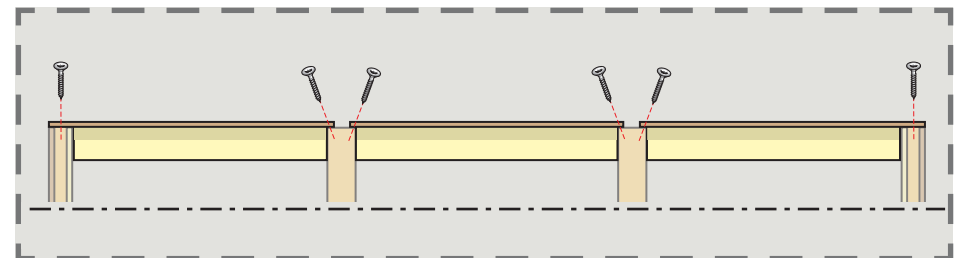
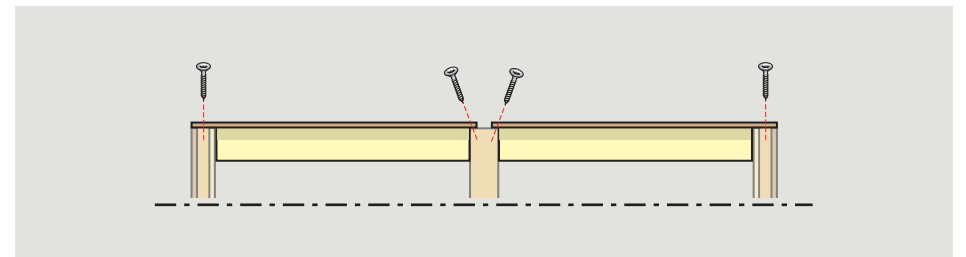
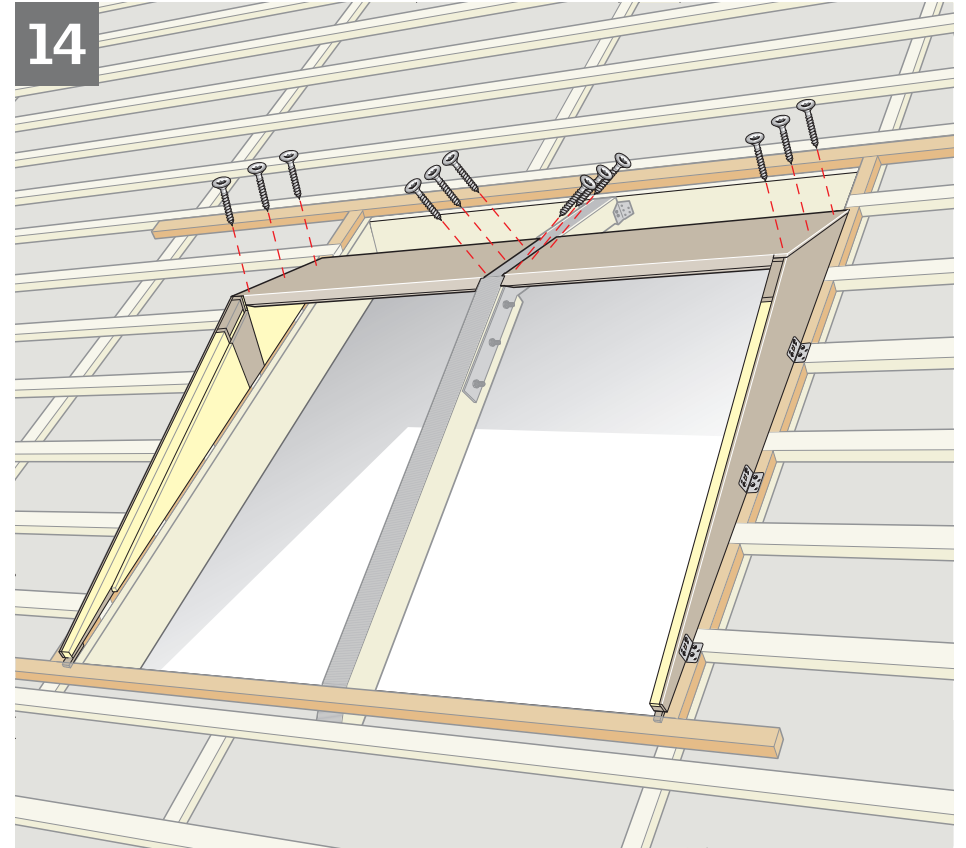
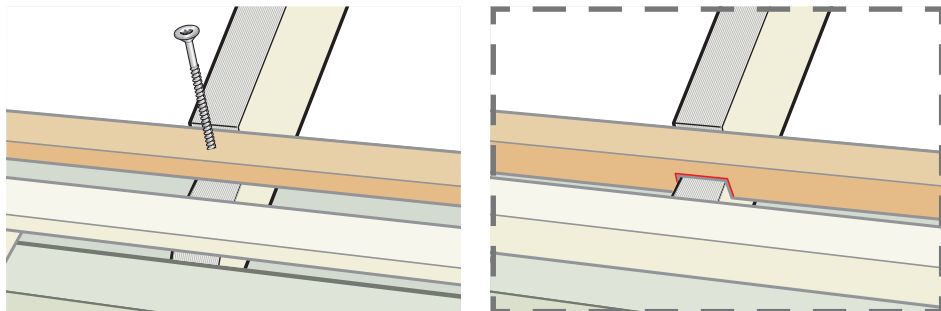
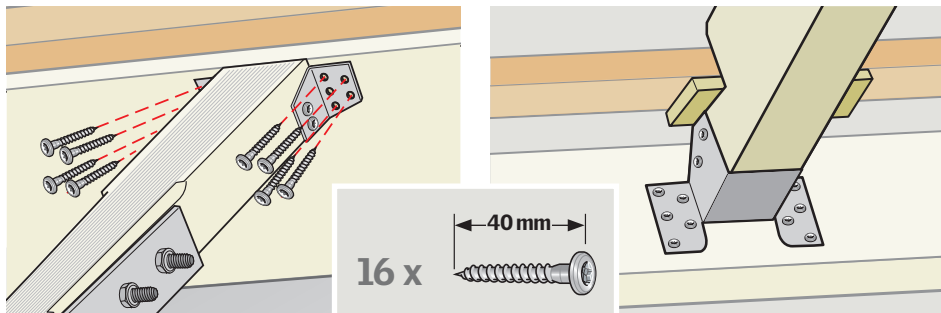
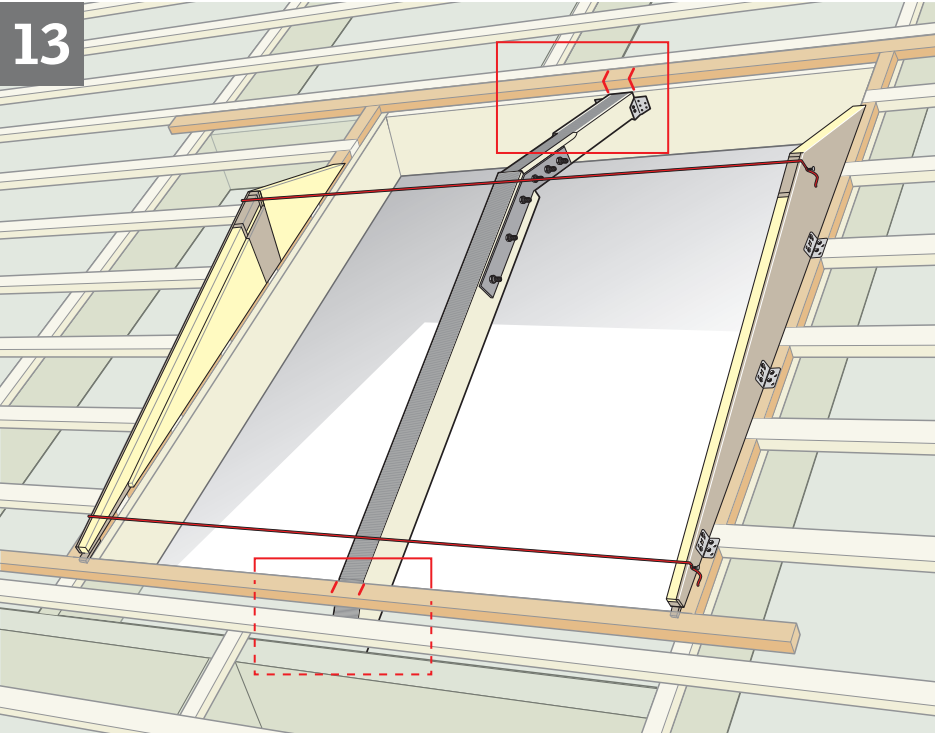



15

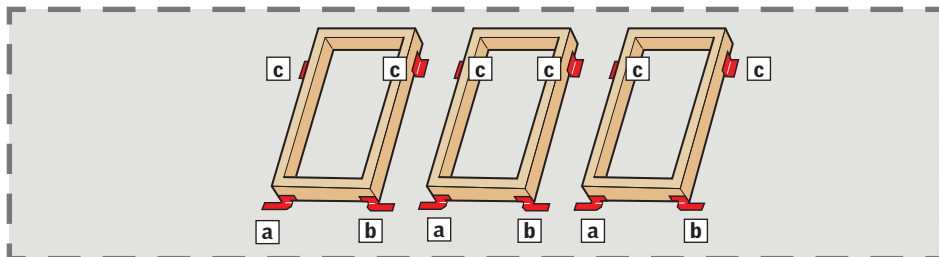
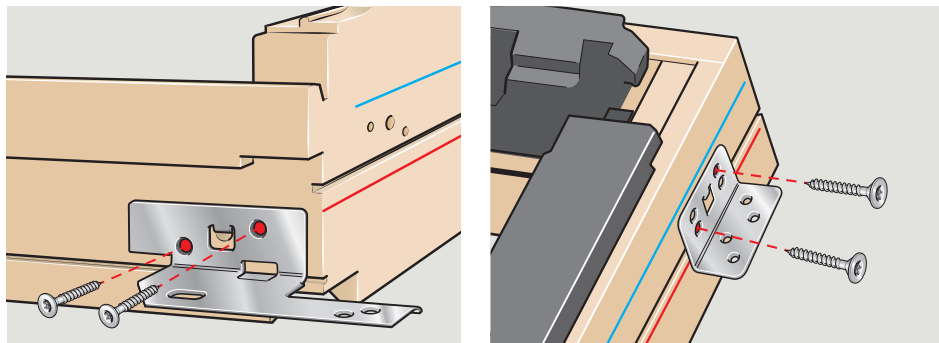
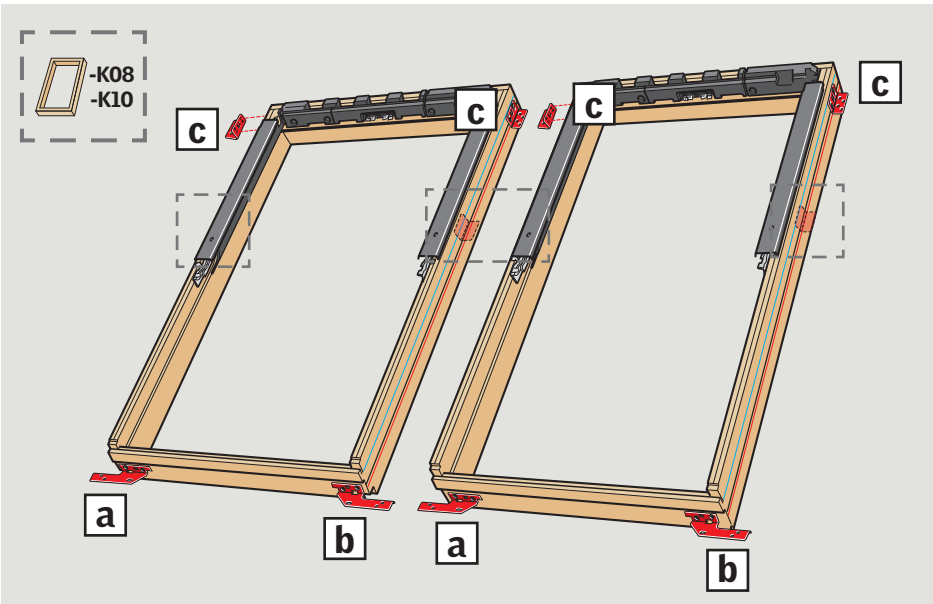

16

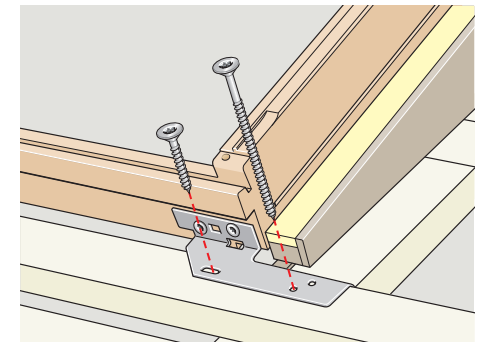
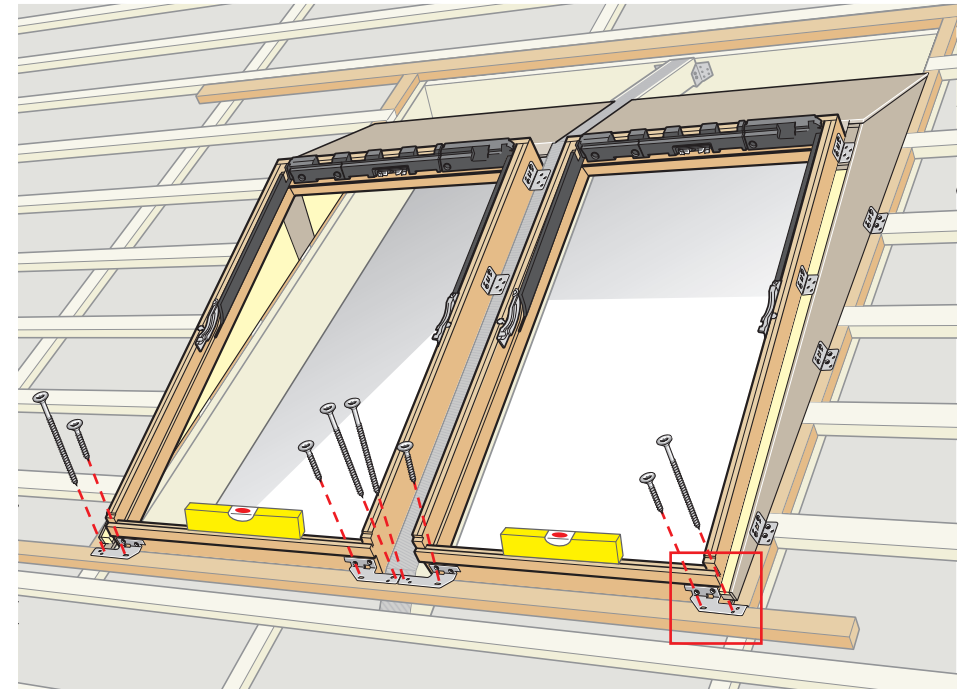
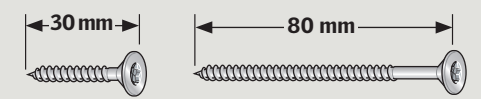

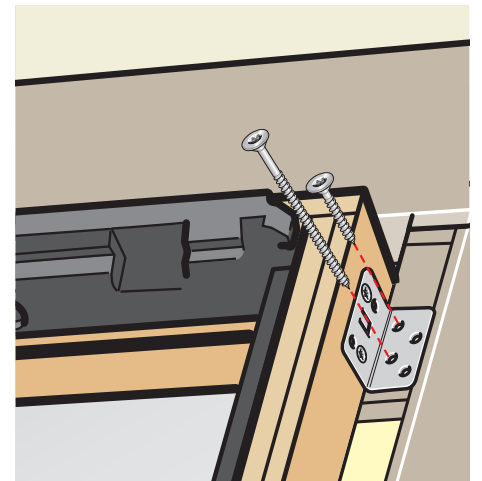
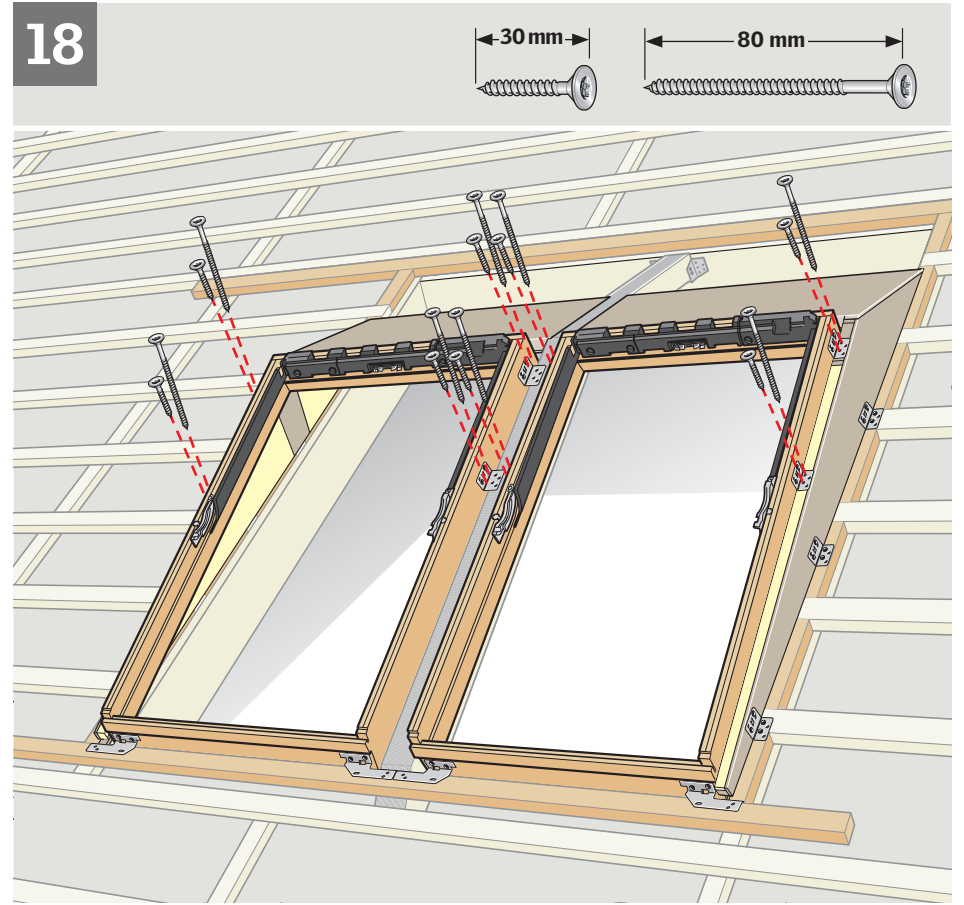
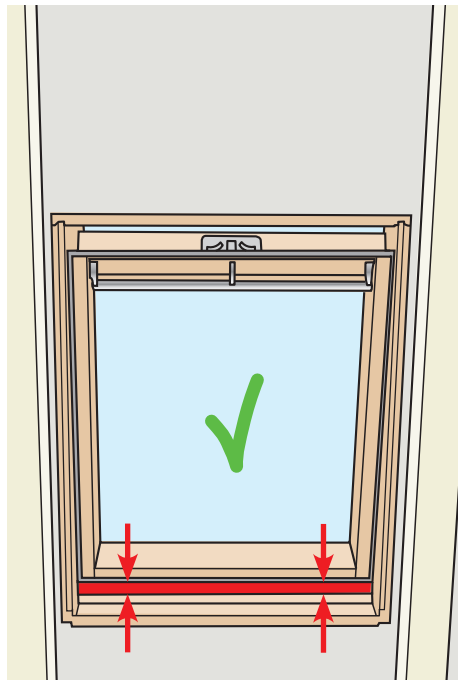
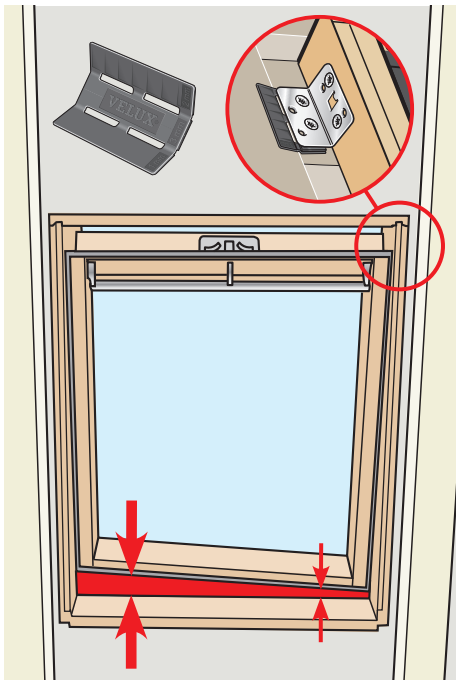
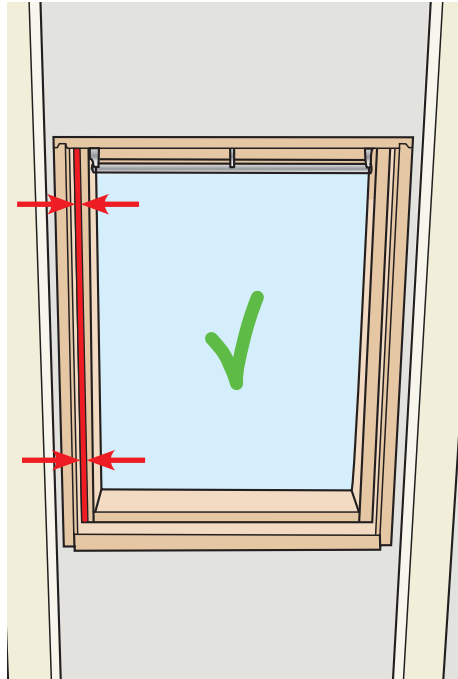
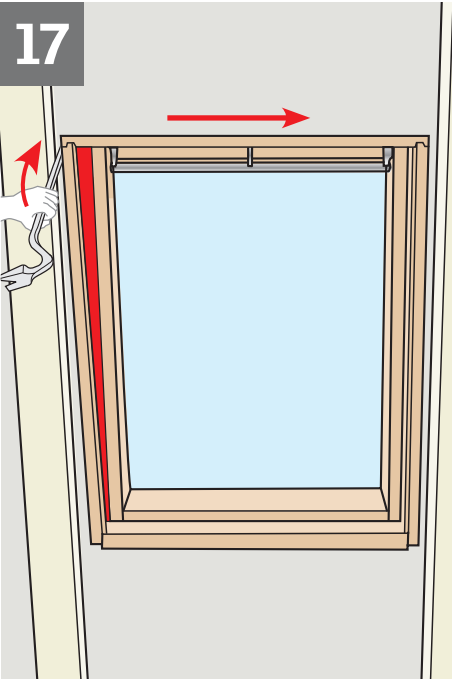

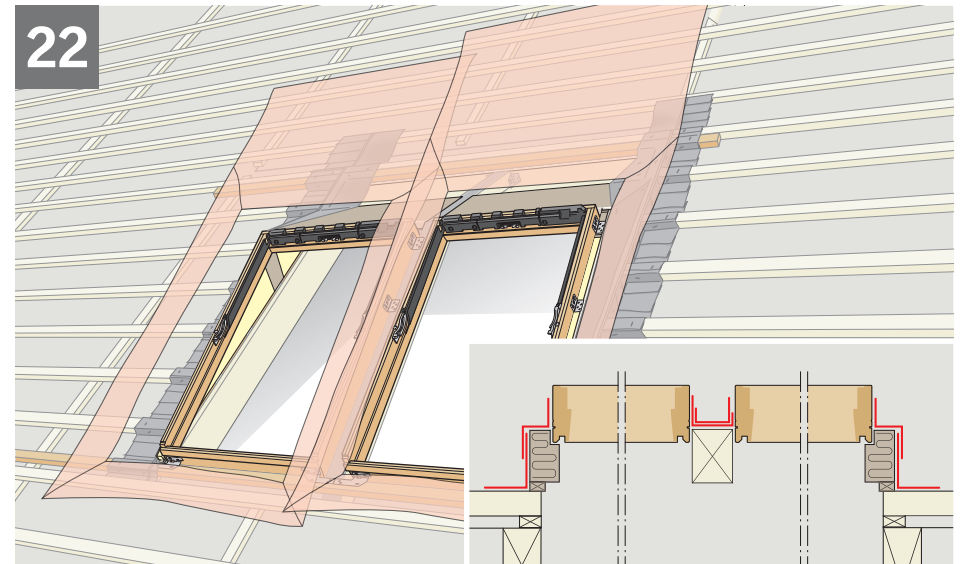
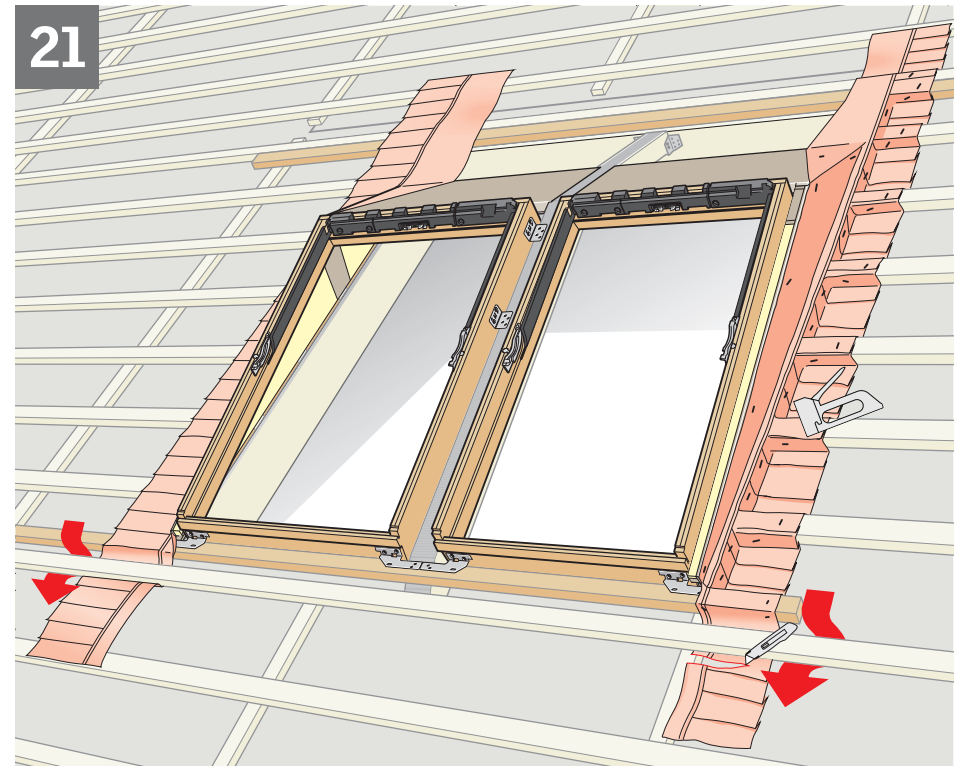
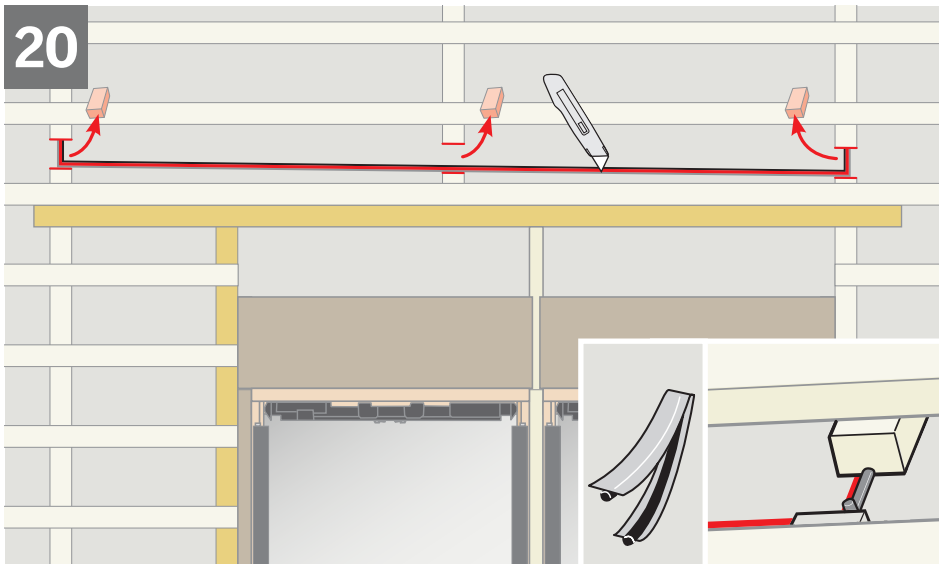
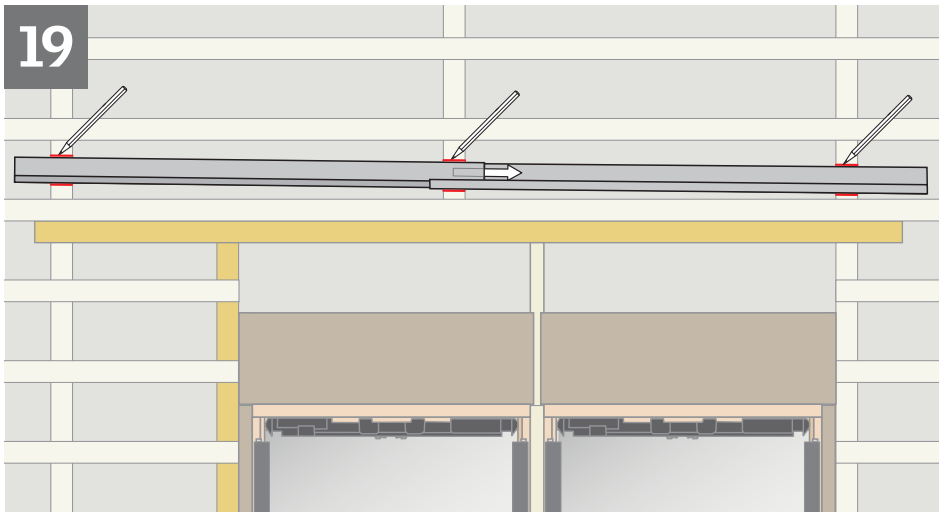
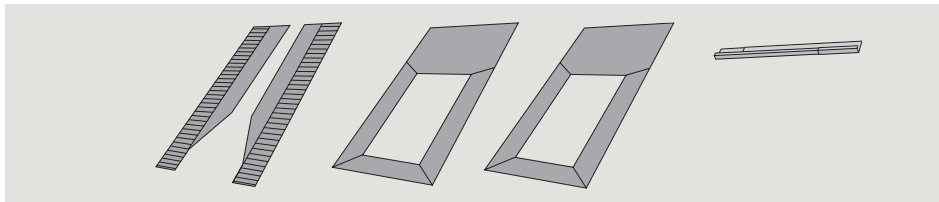

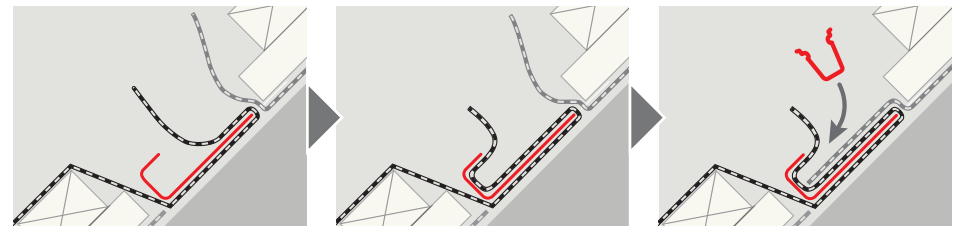
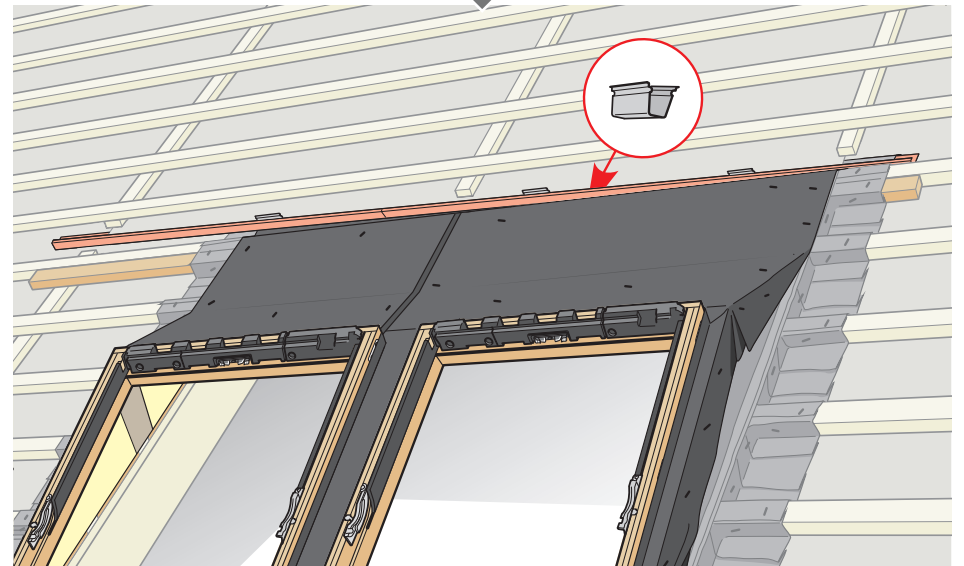
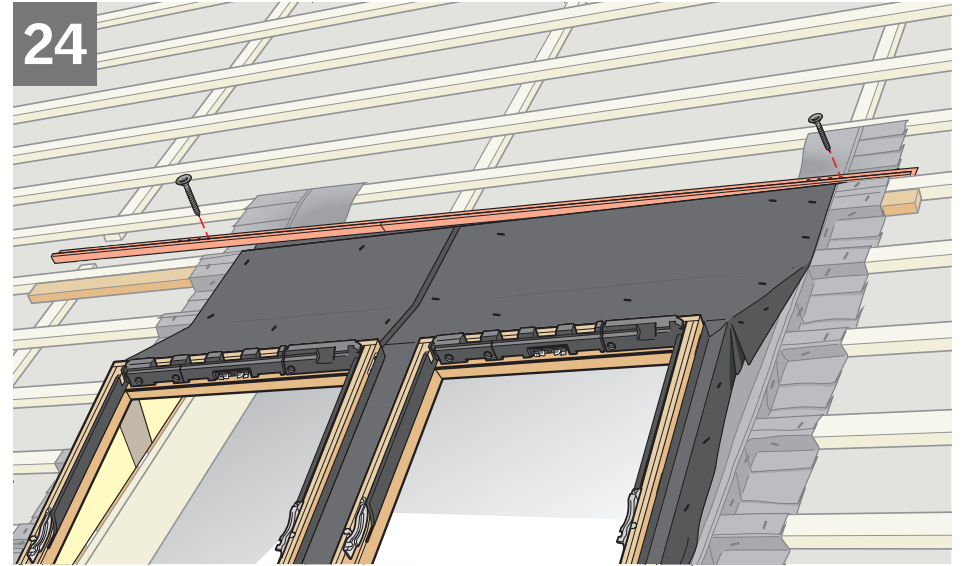
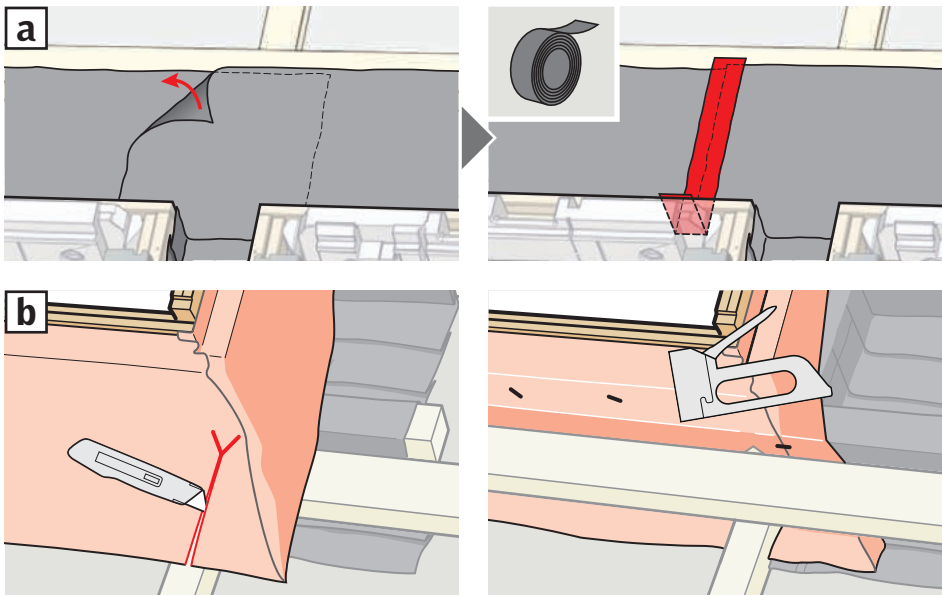
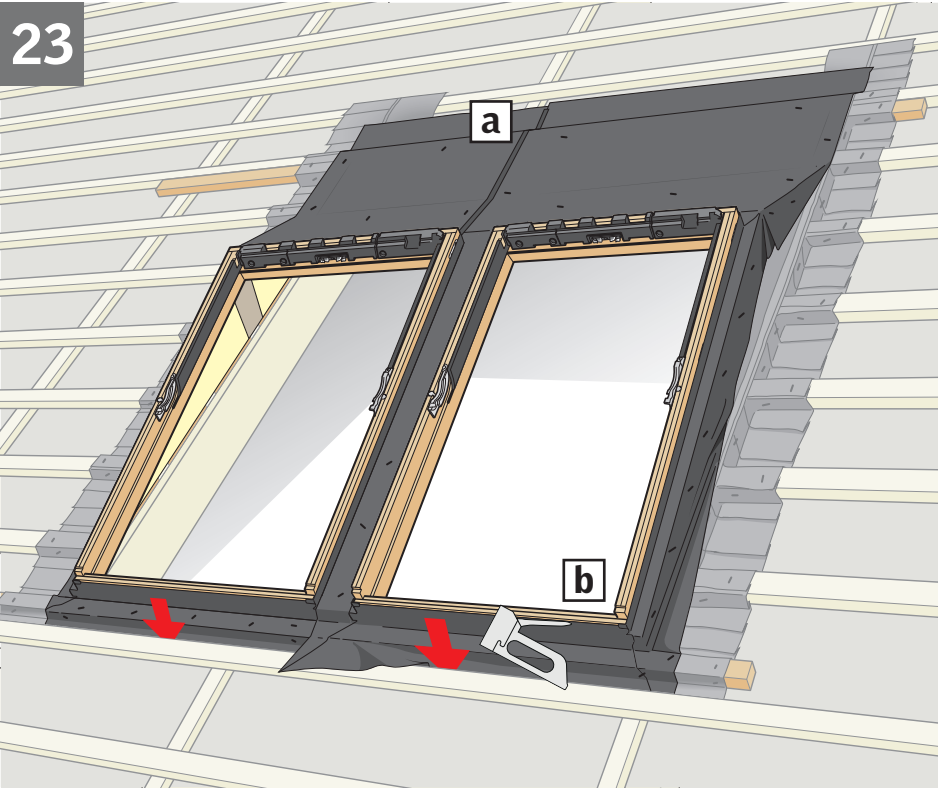



25

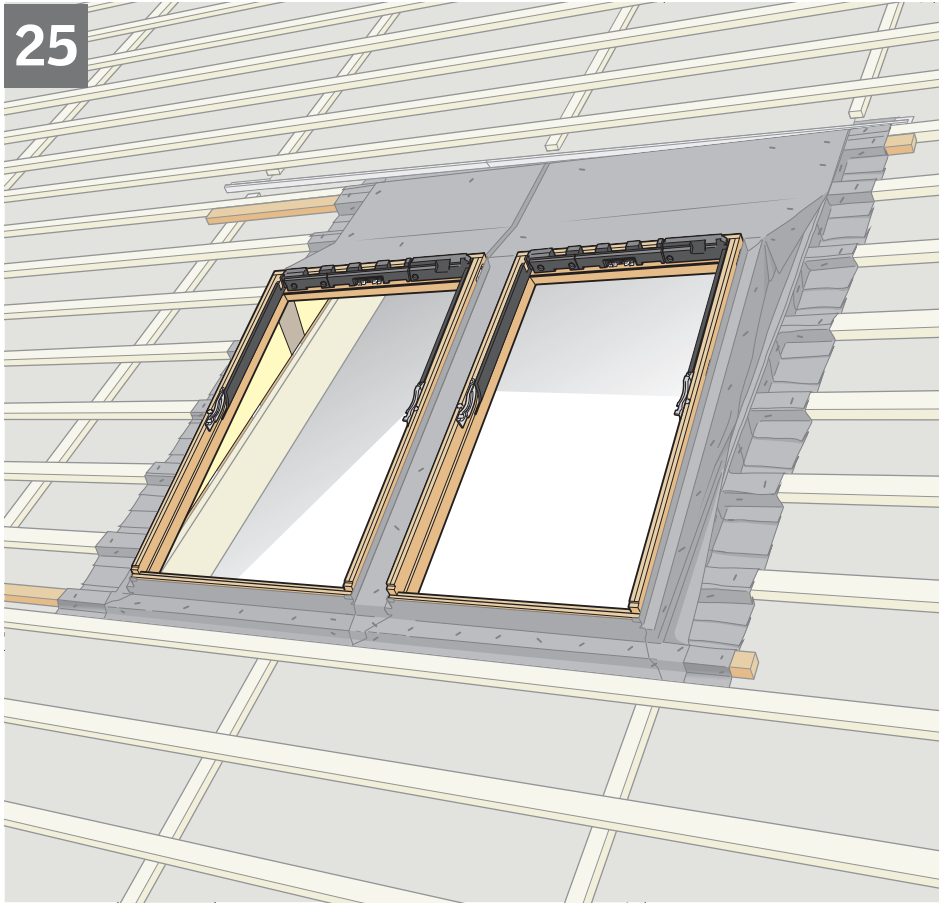

# EAZ

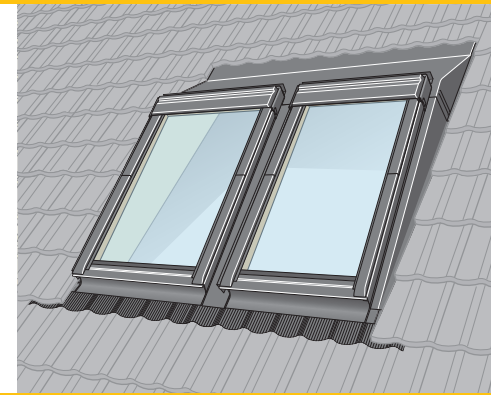
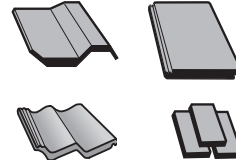

Pages  
30-37

# EAW

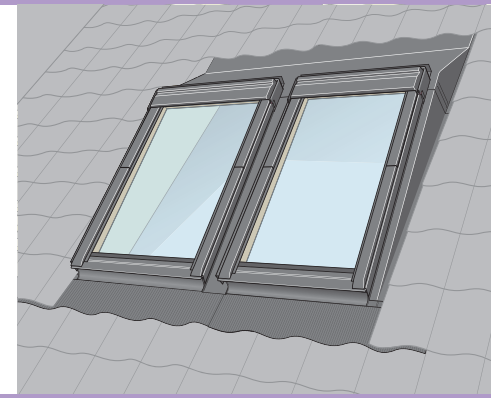
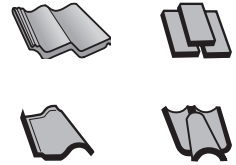

Pages  
38-45

# EAS

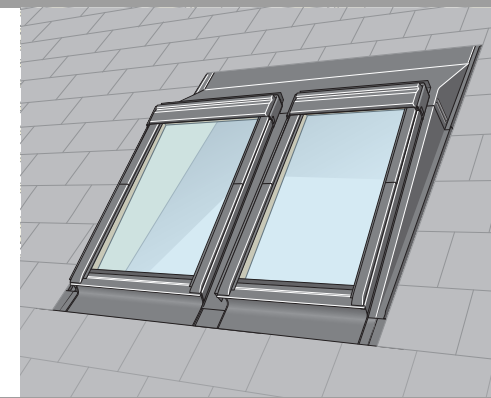
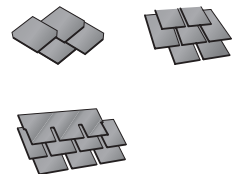

Pages  
46-51

26 EAZ

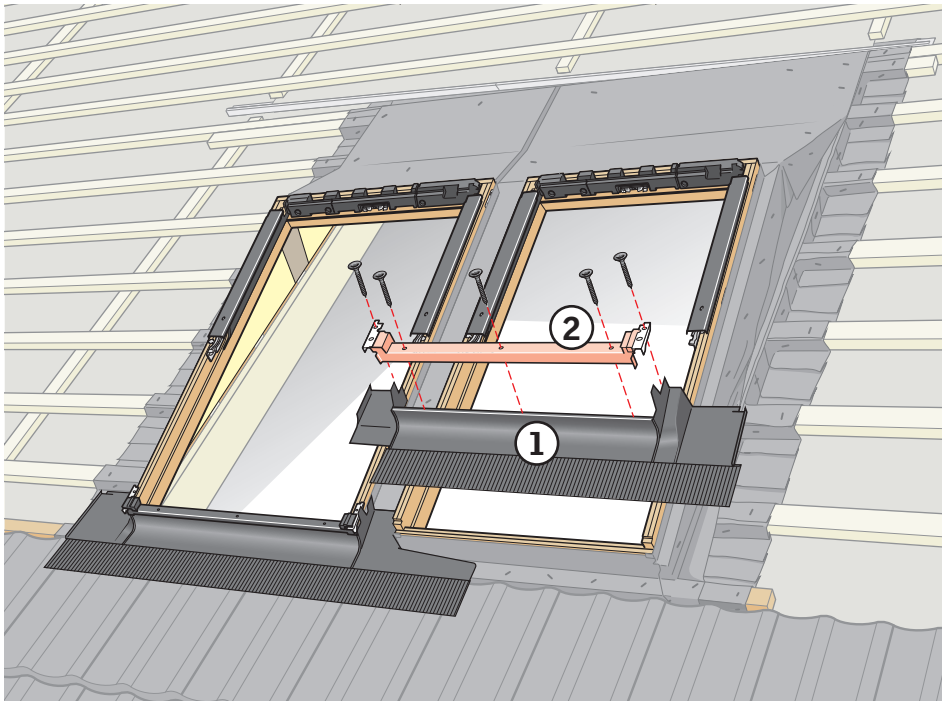
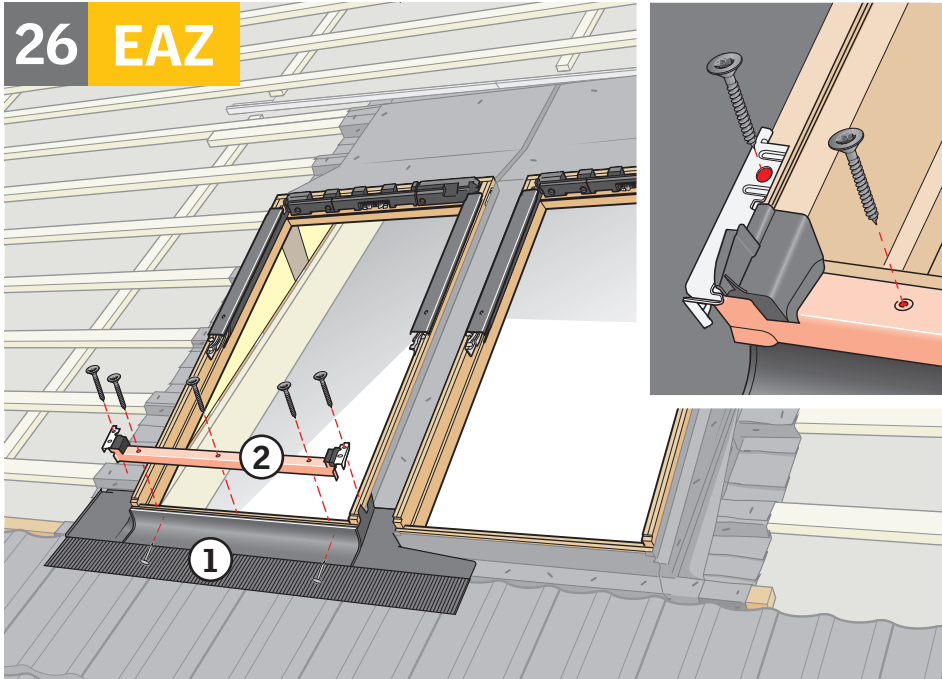

27

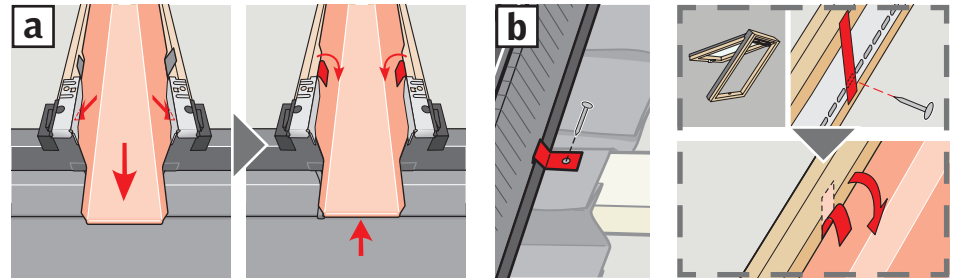
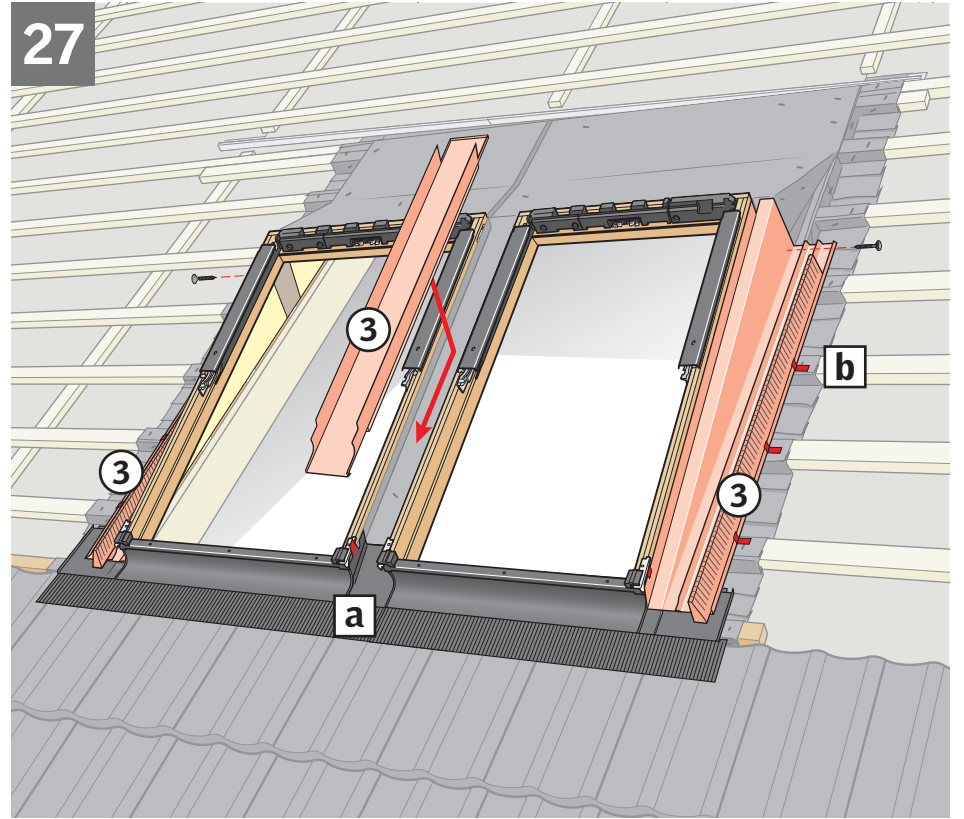

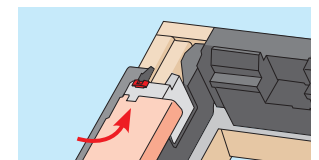
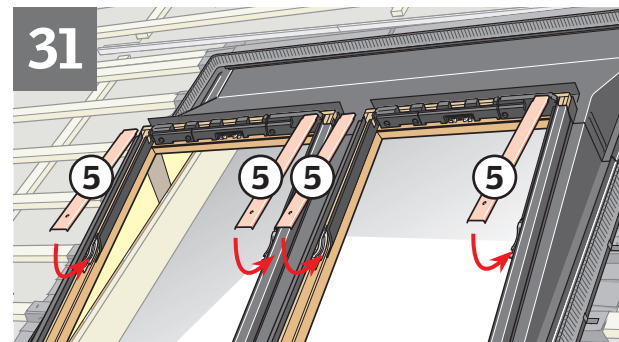
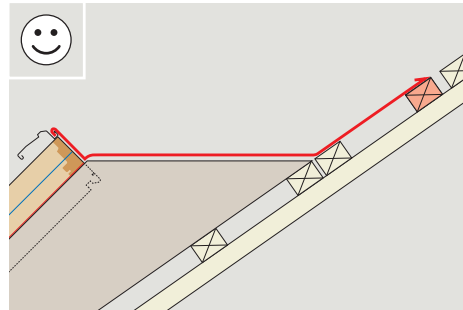
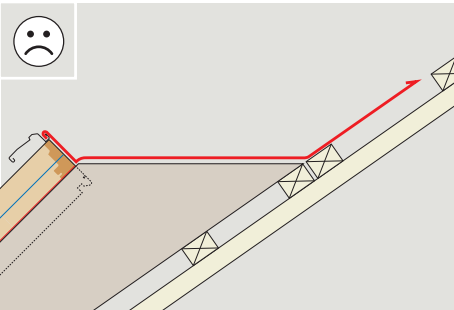
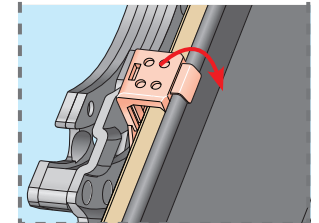
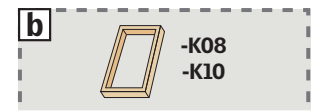
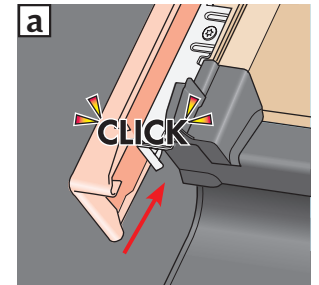
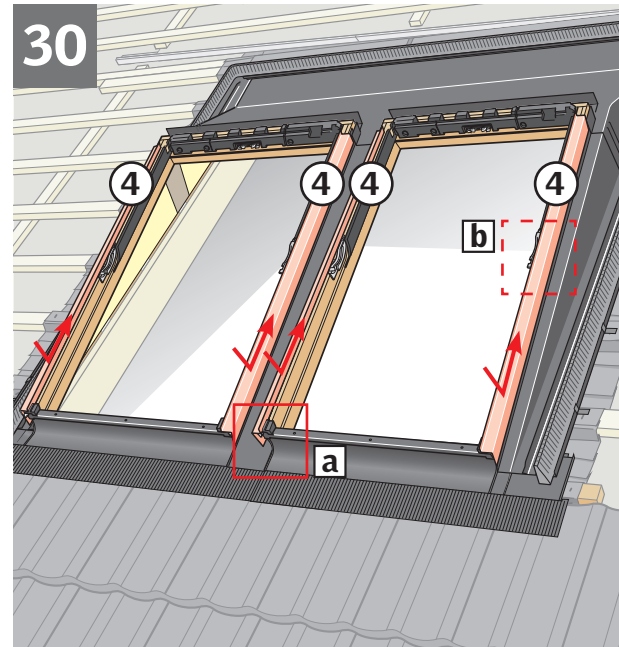
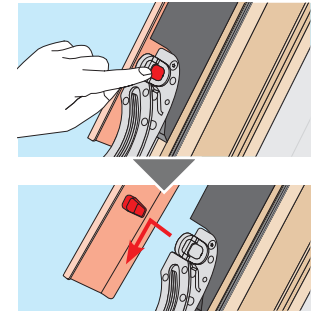
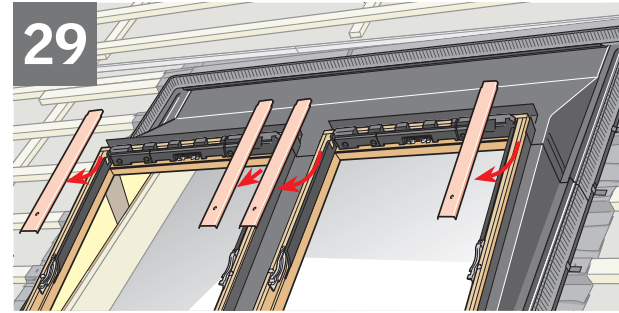
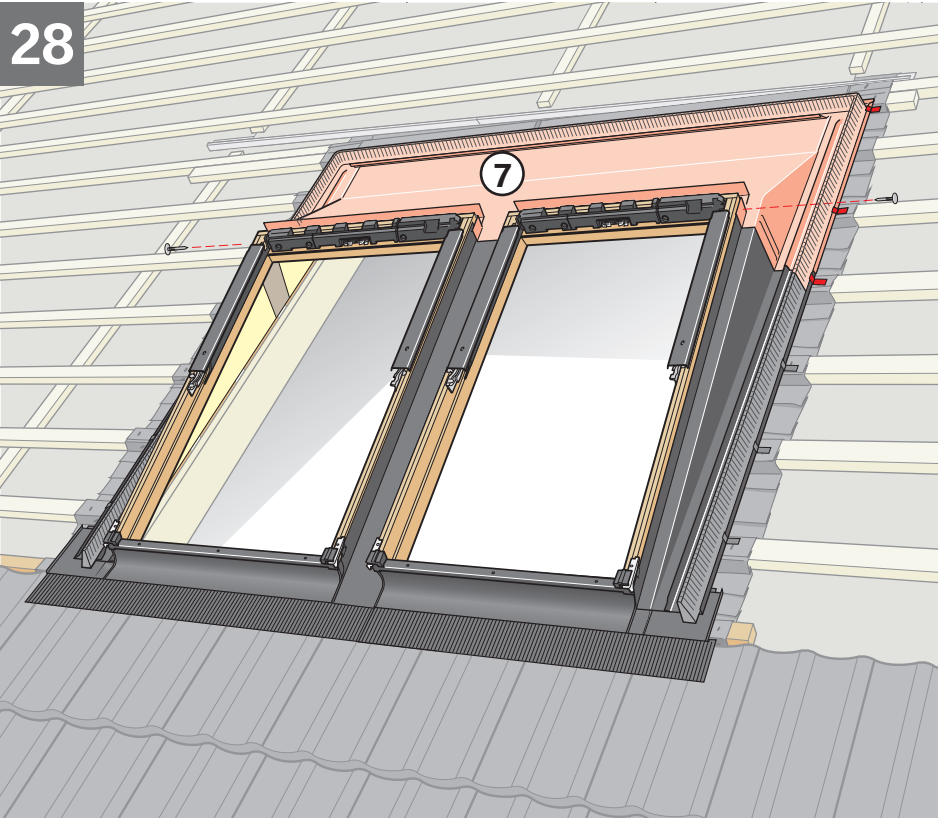



32

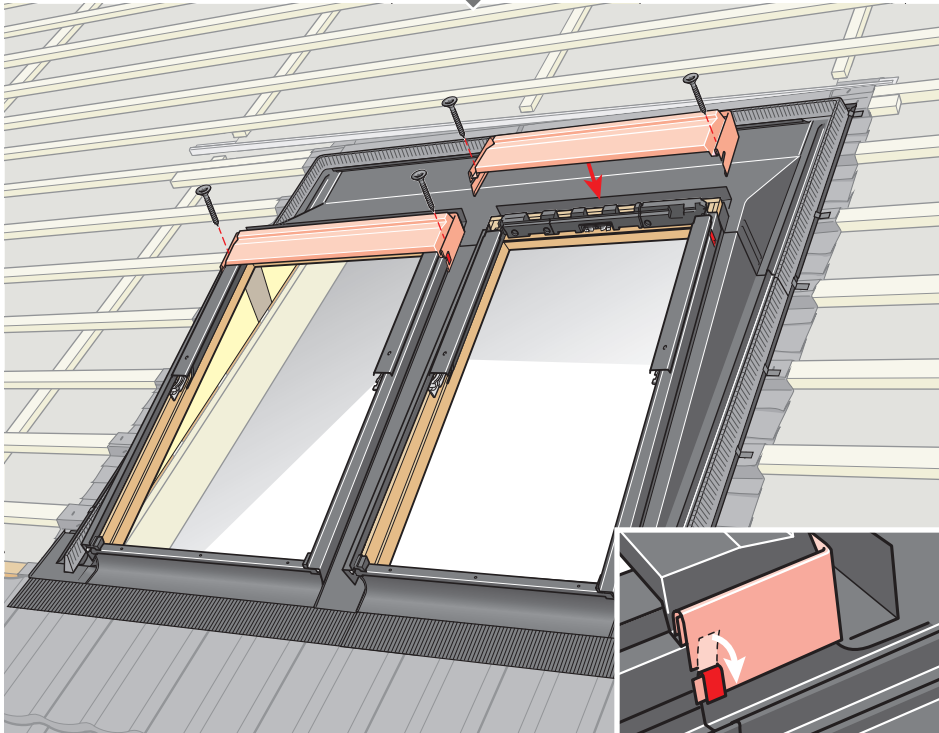
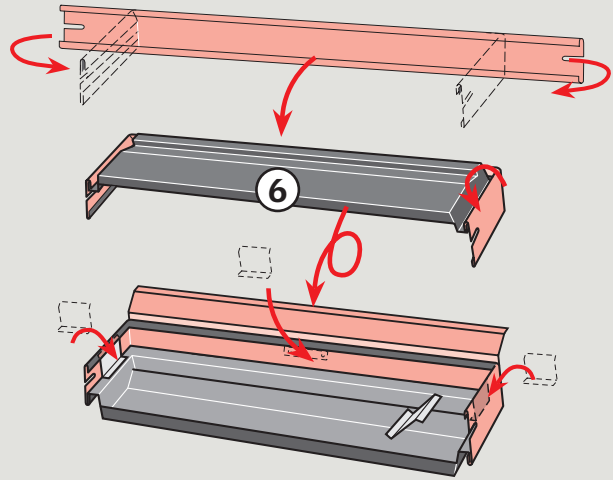

33

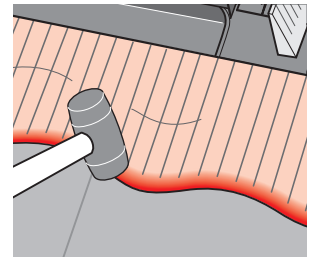



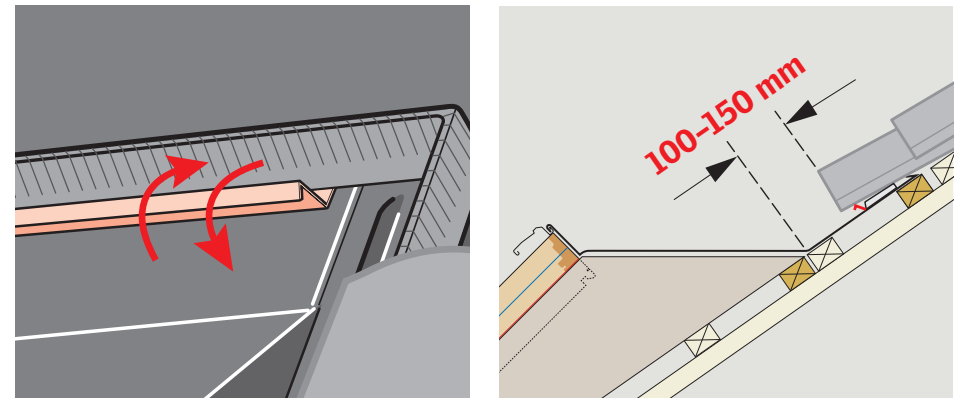
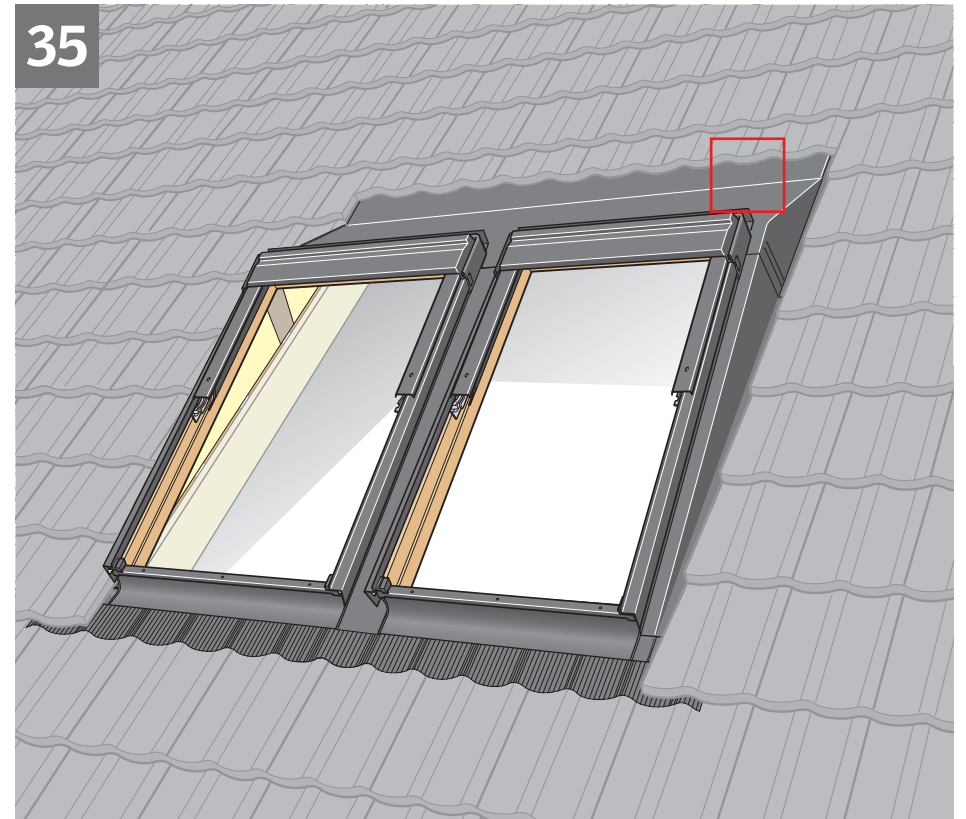
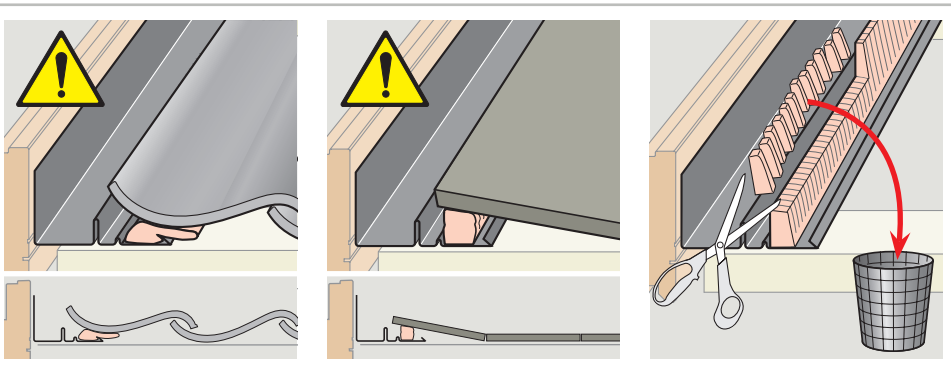
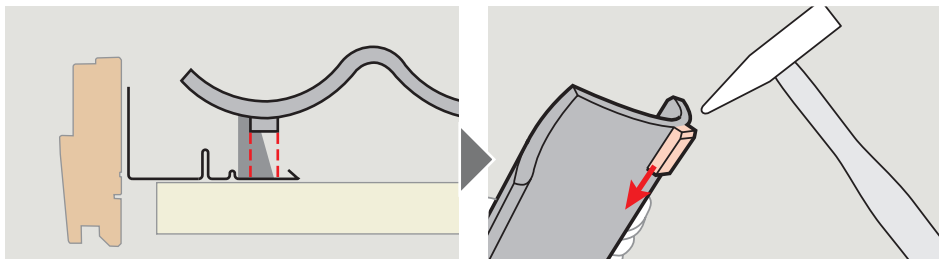
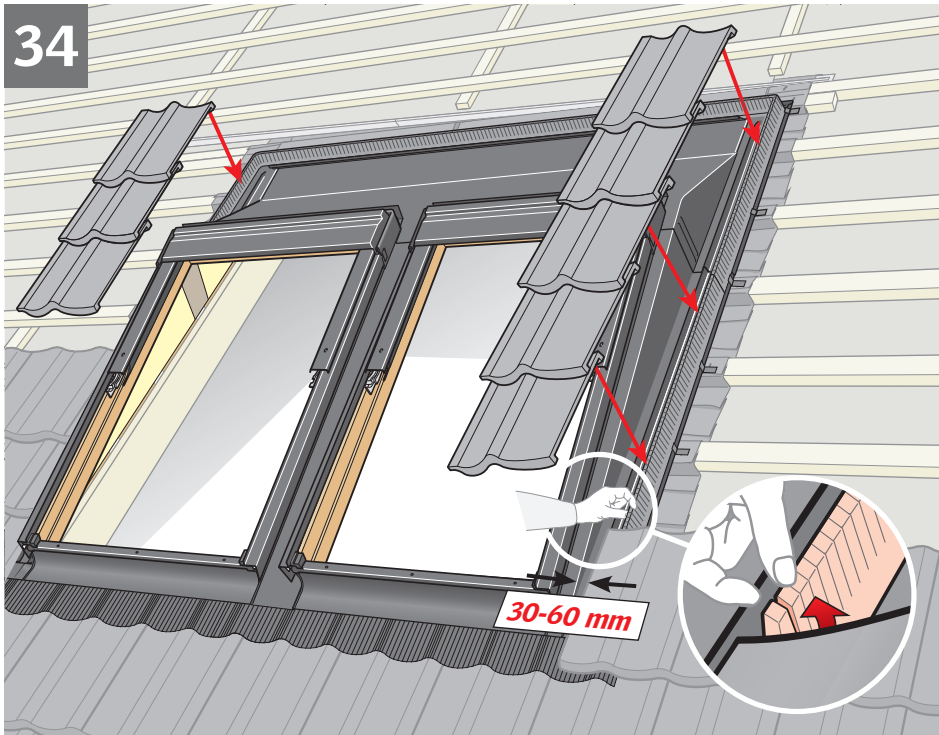

26 EAW

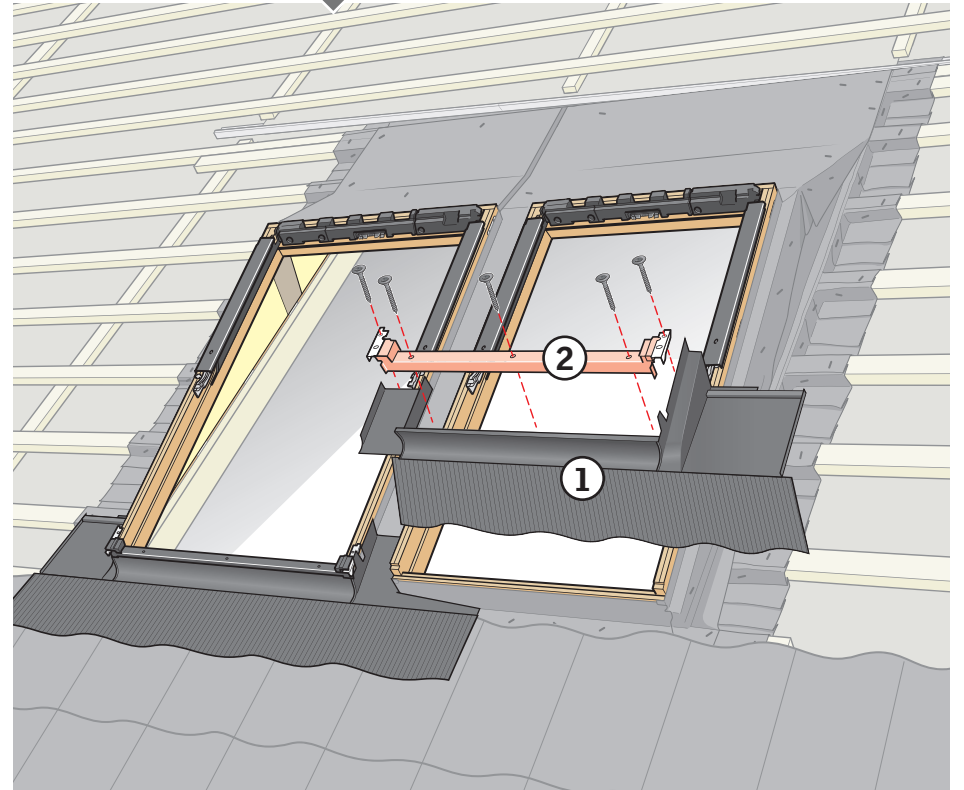
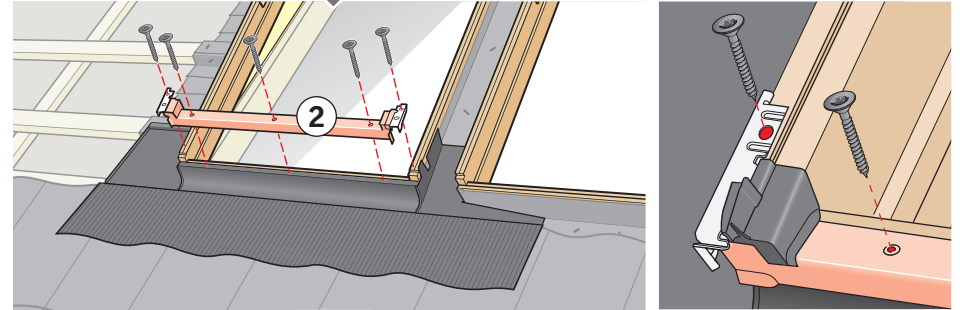
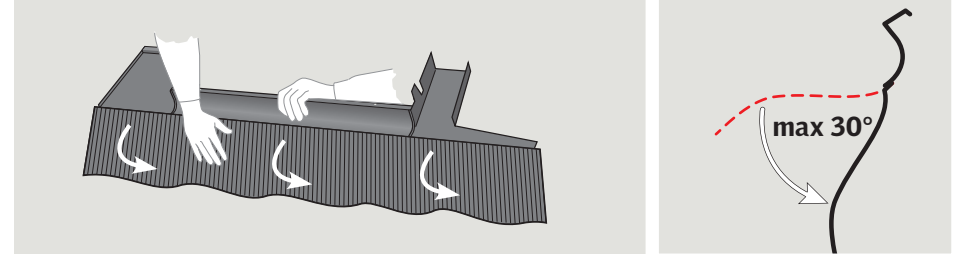
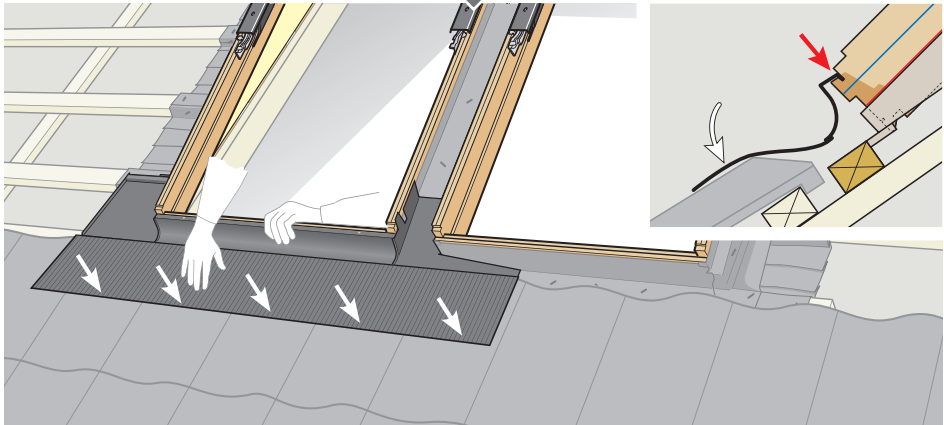
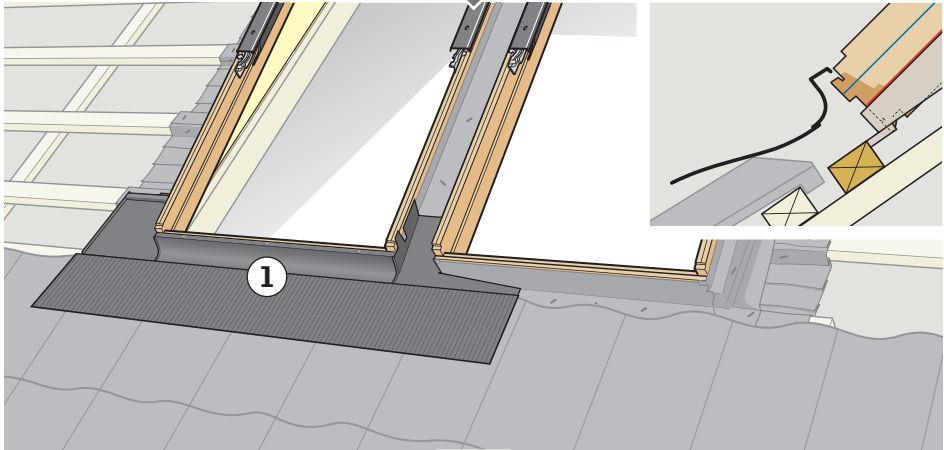
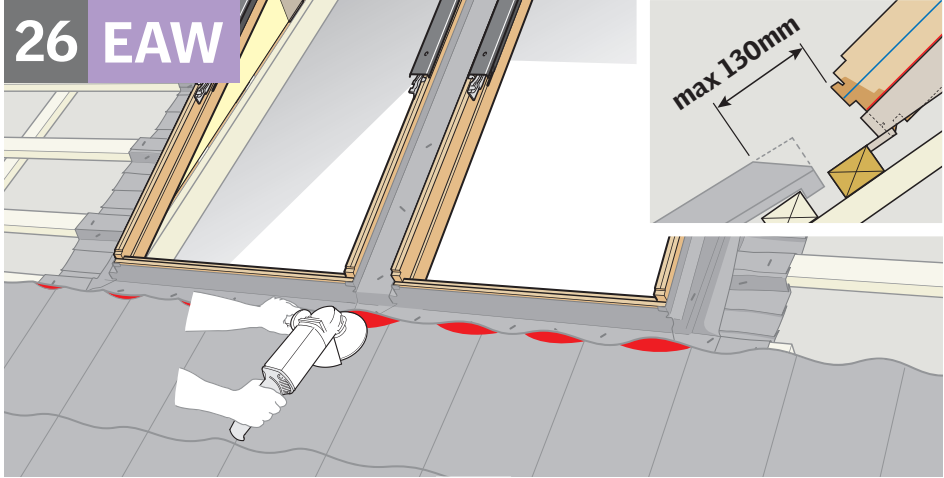

27

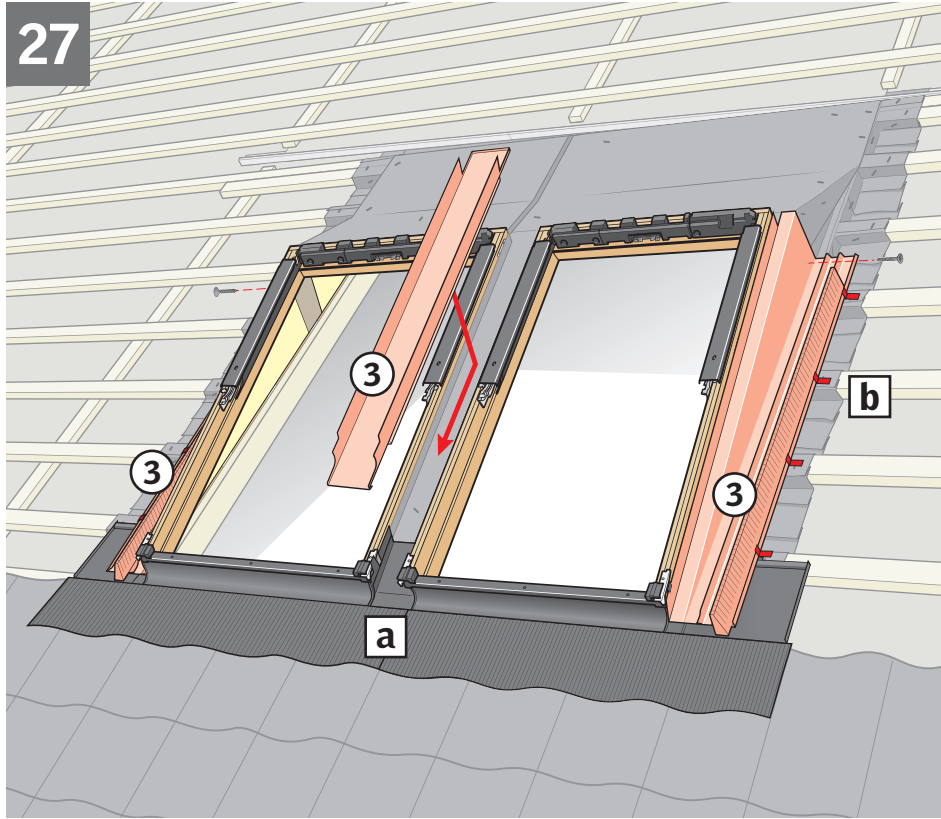

28

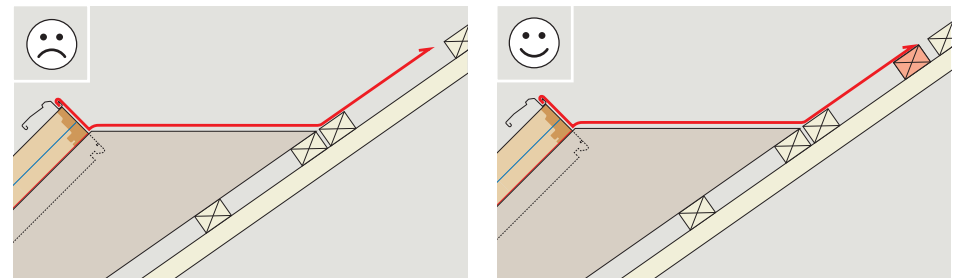
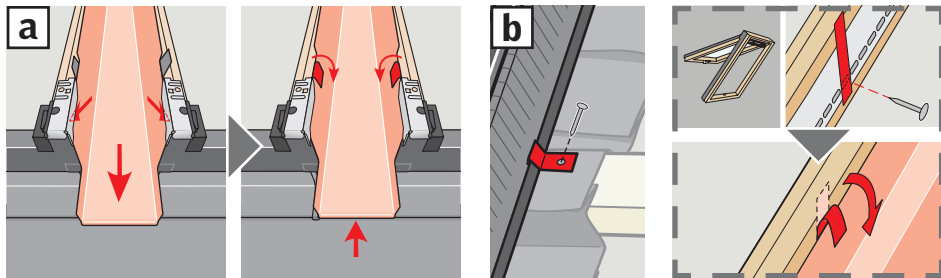
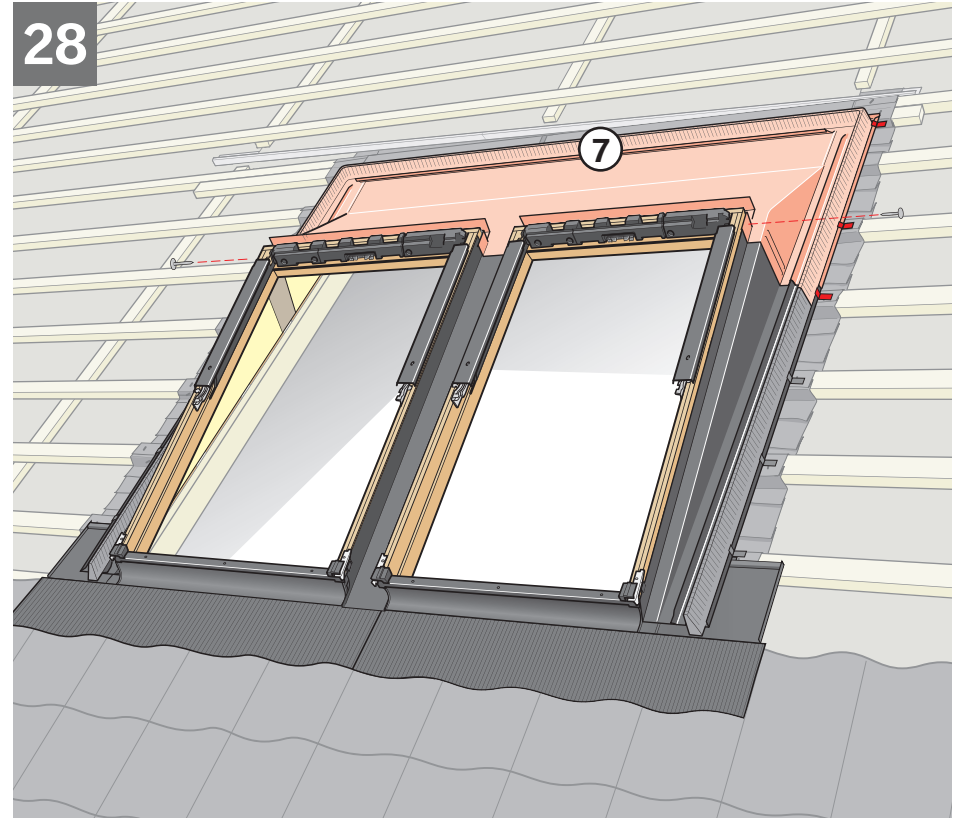



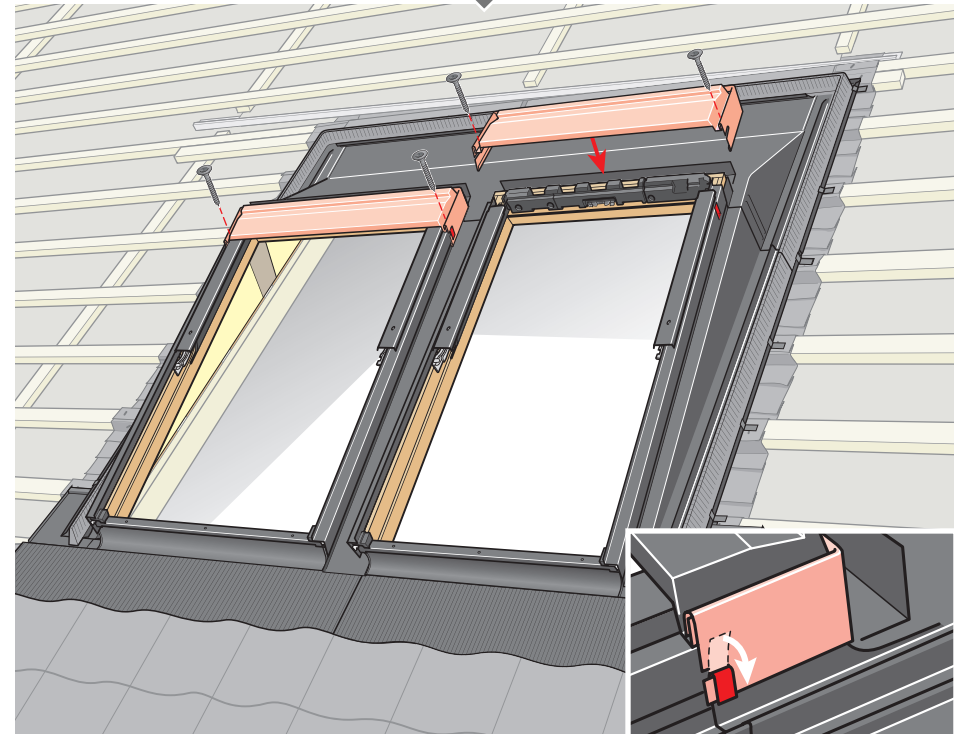
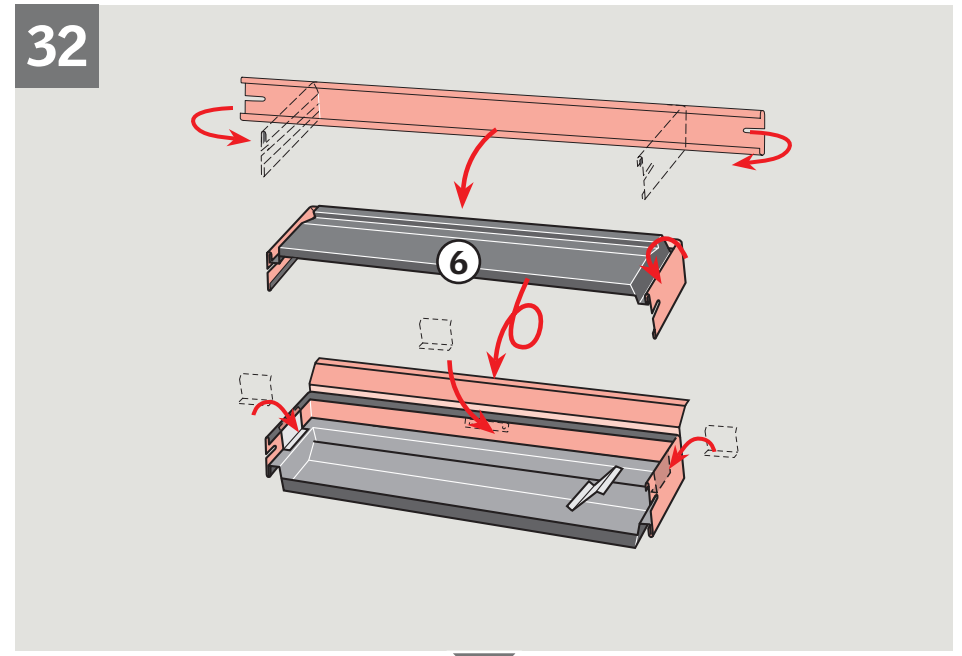
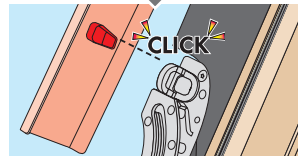
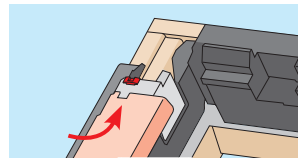
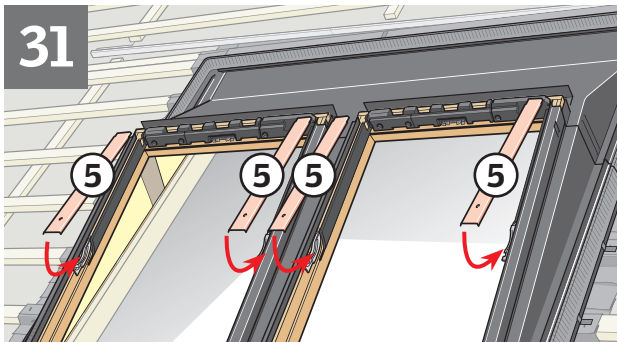
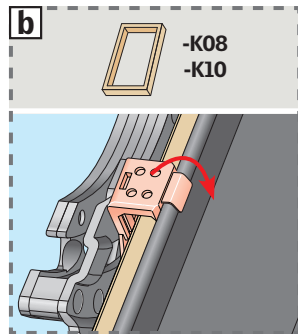
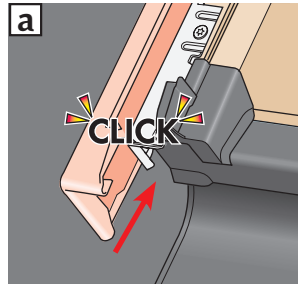
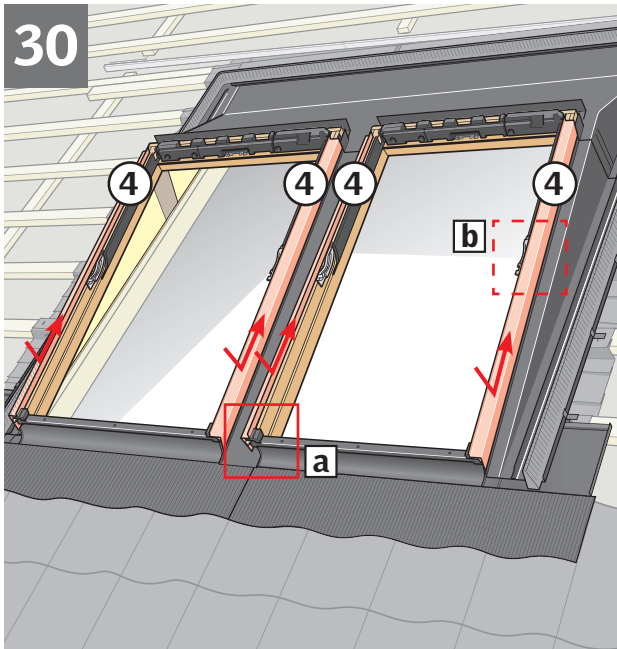
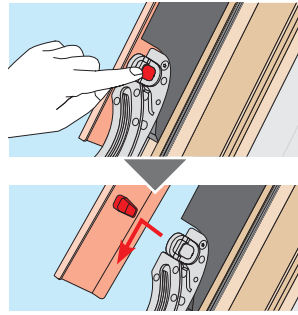
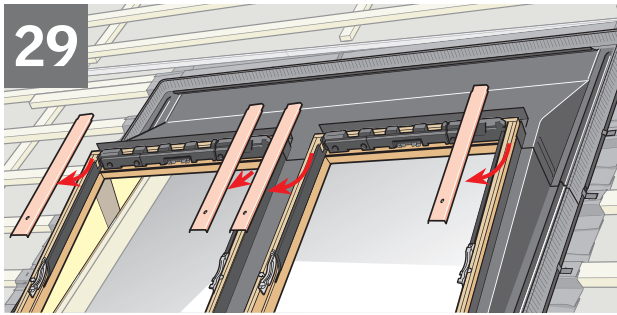

33

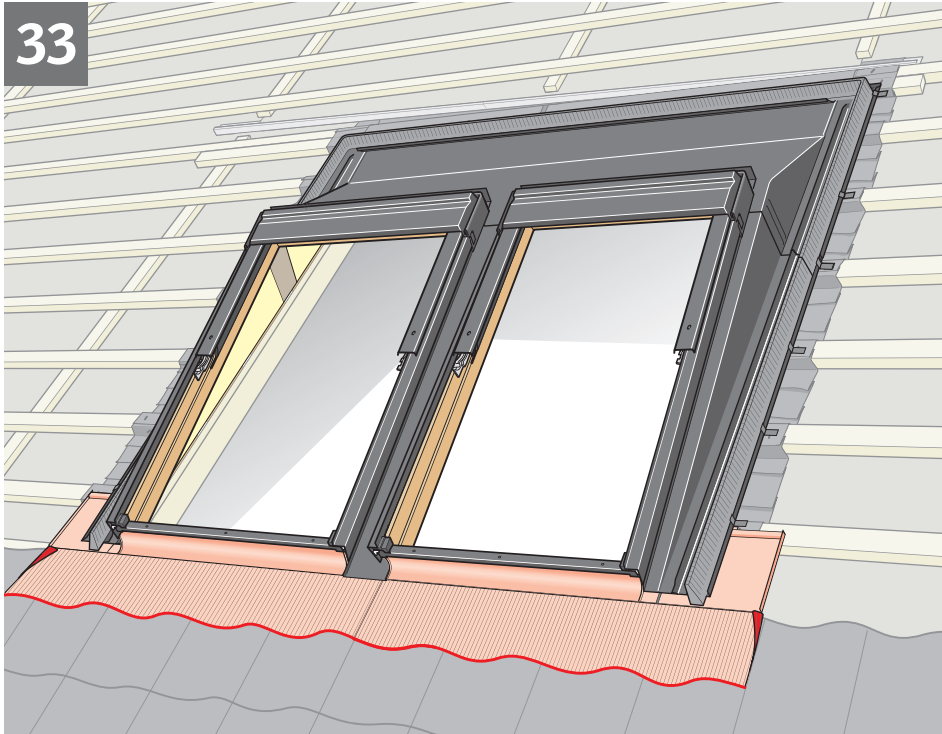

34

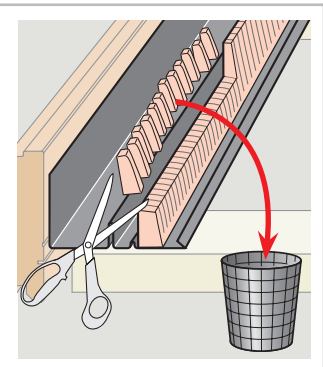
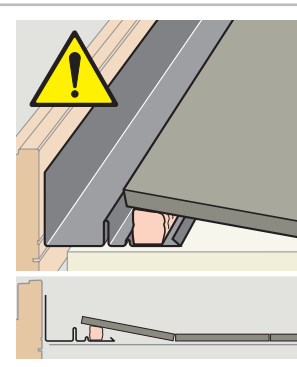
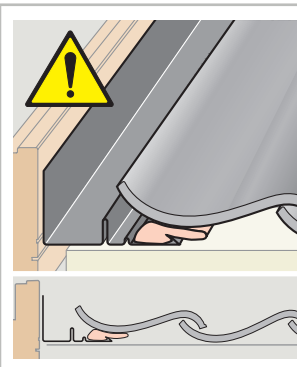
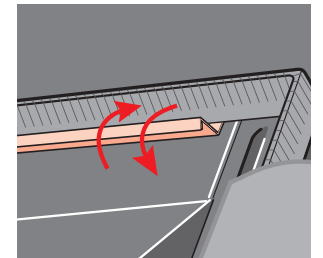
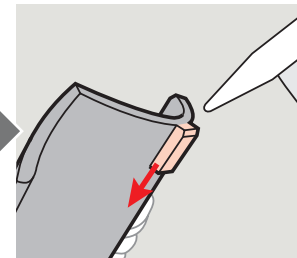
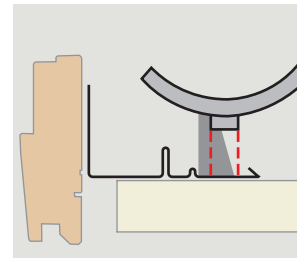
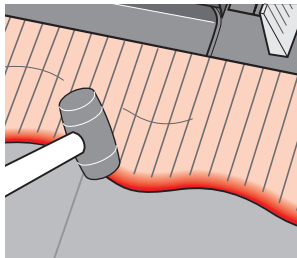
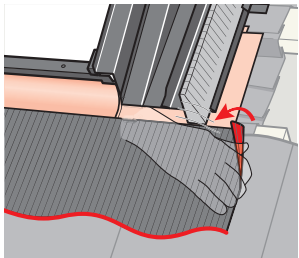
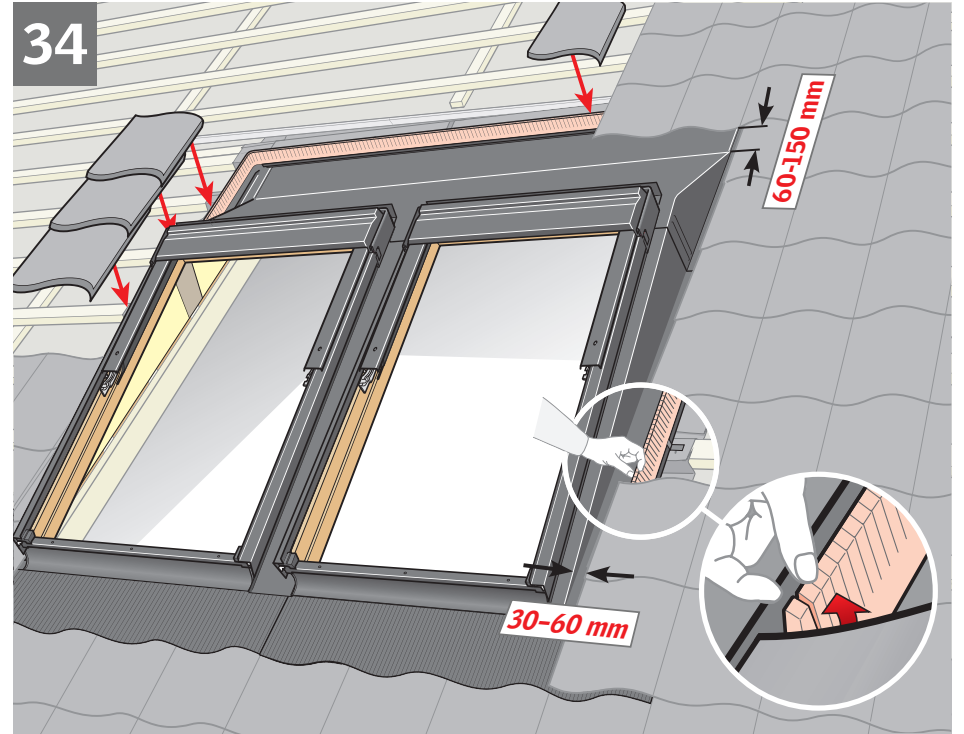

# 26 EAS

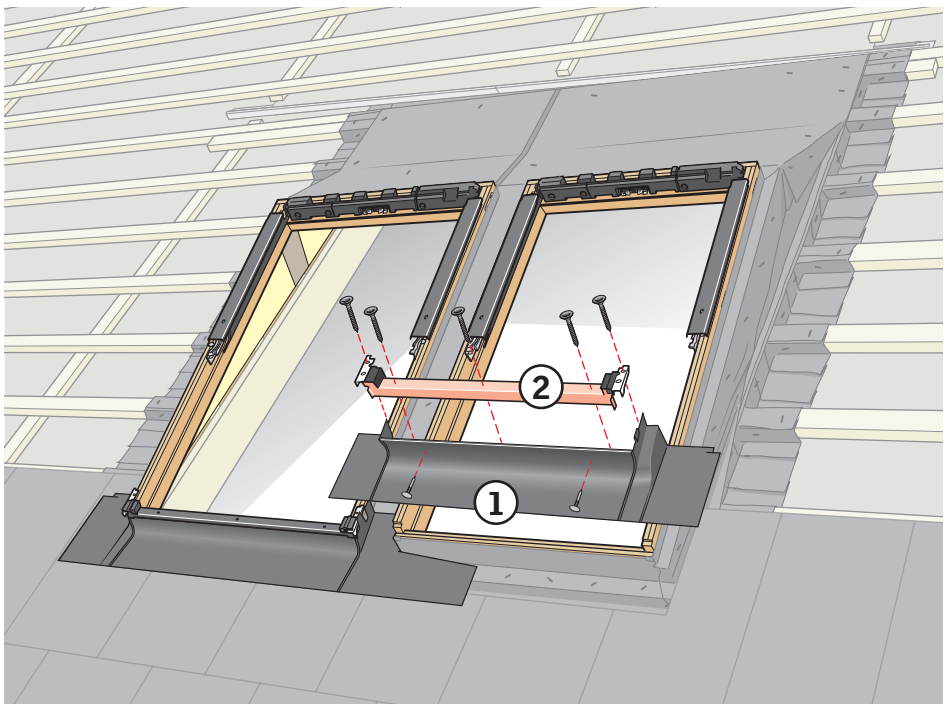
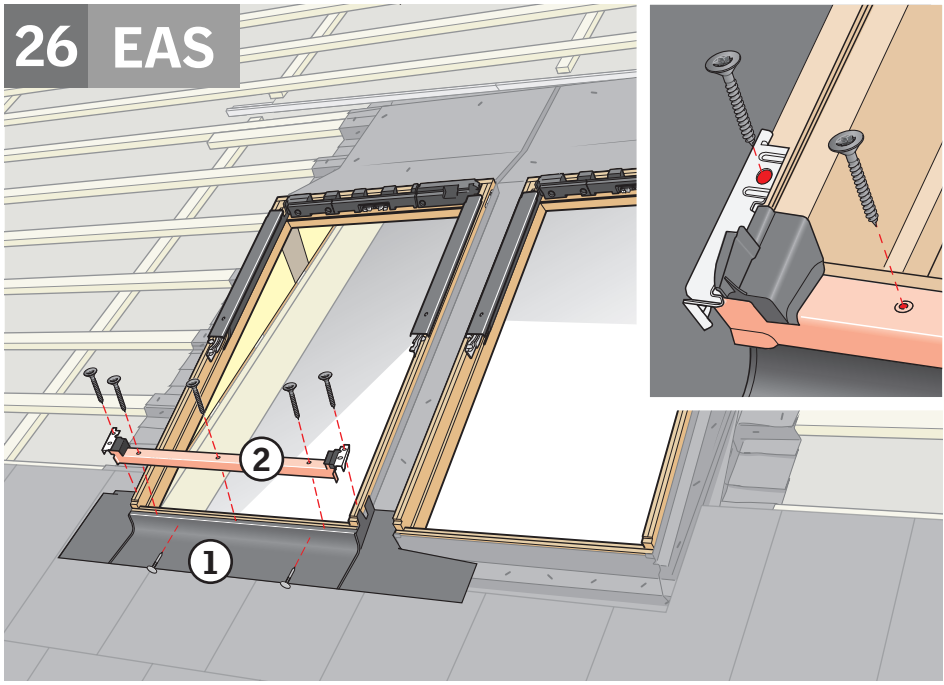

# 27

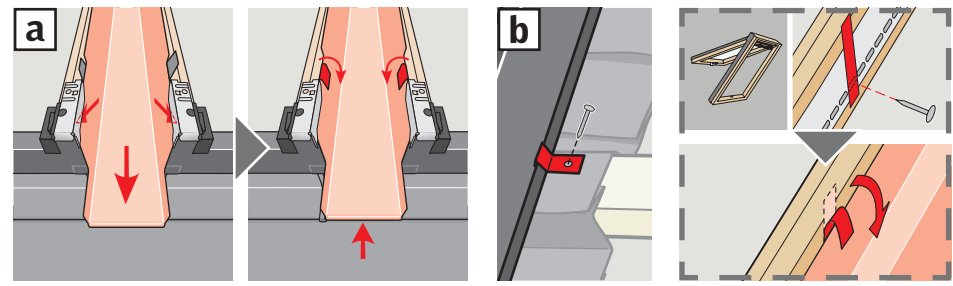
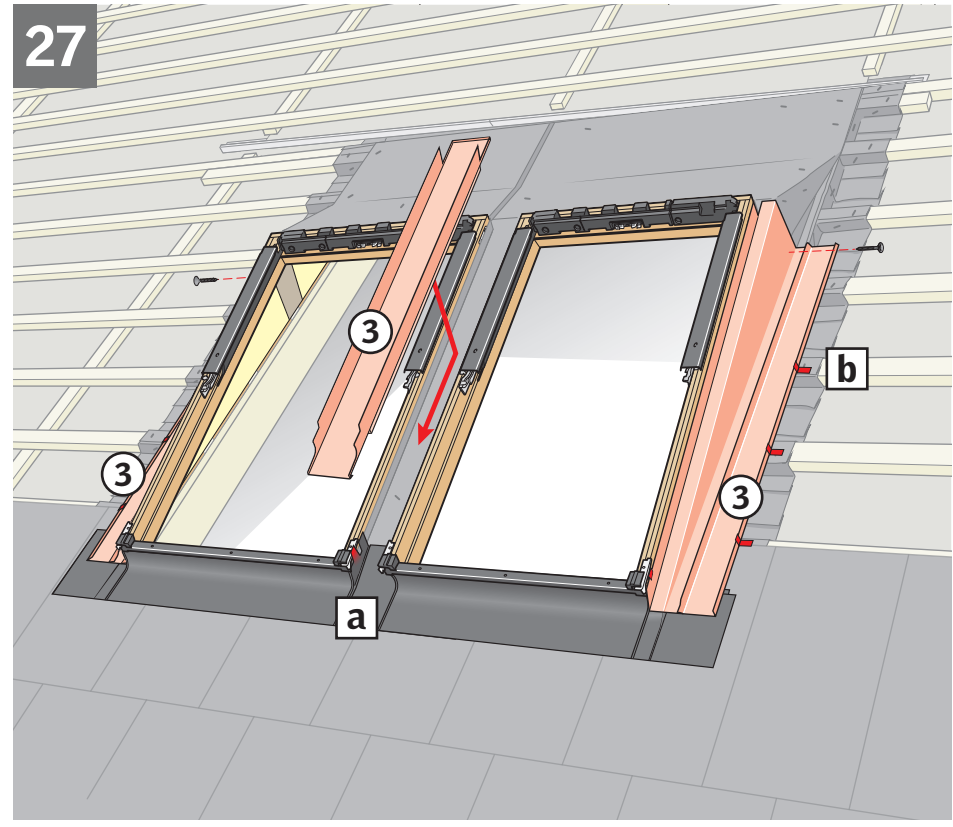



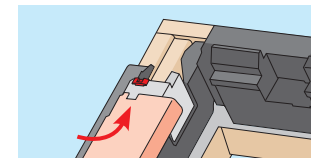
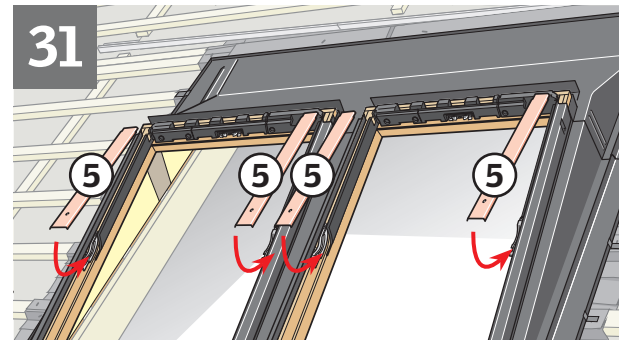
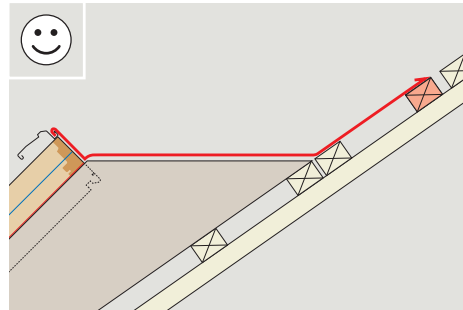
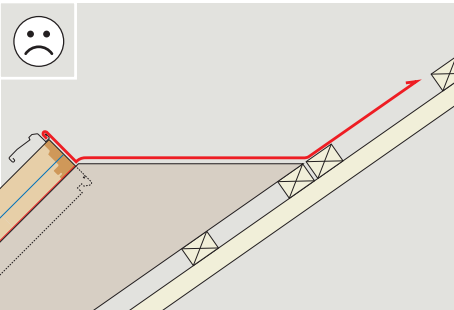
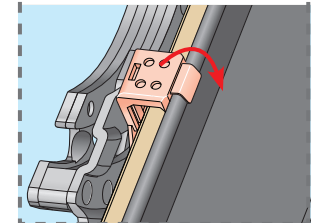
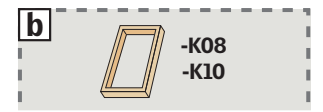
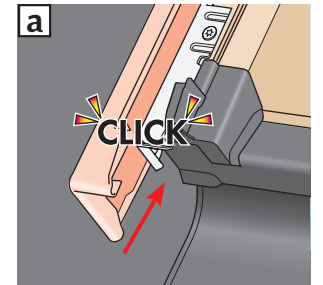
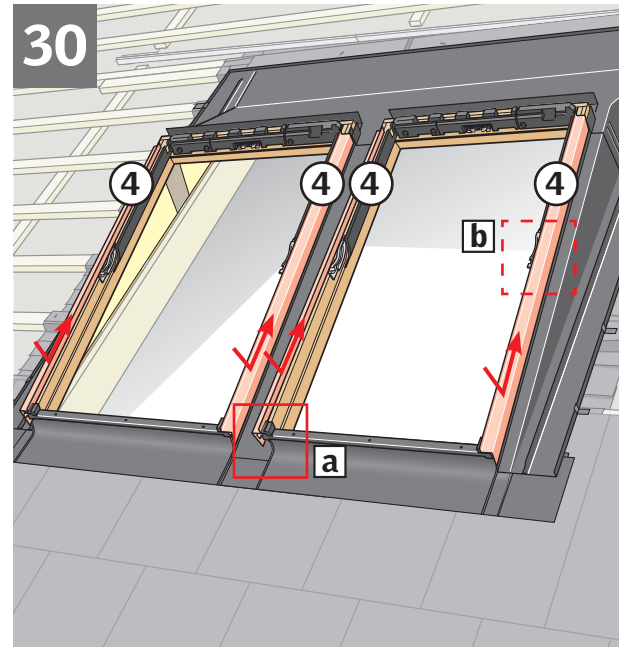
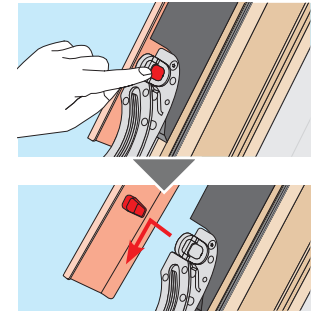
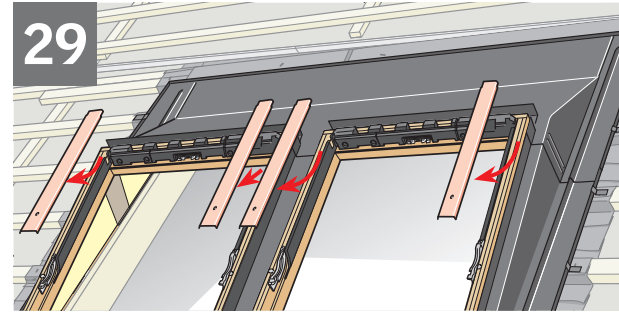
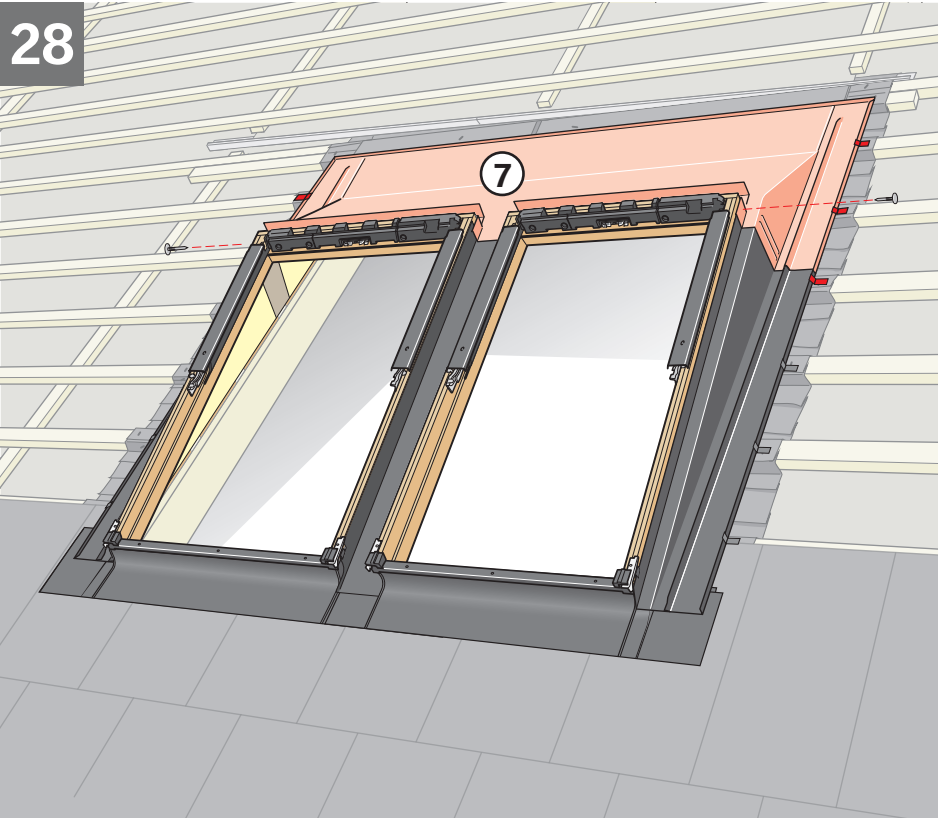

32

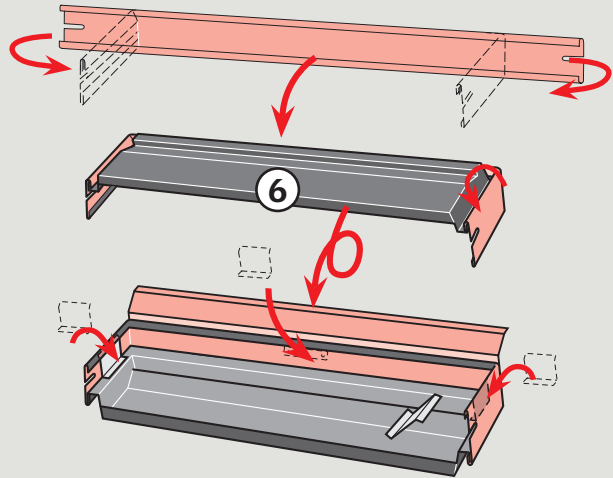

33

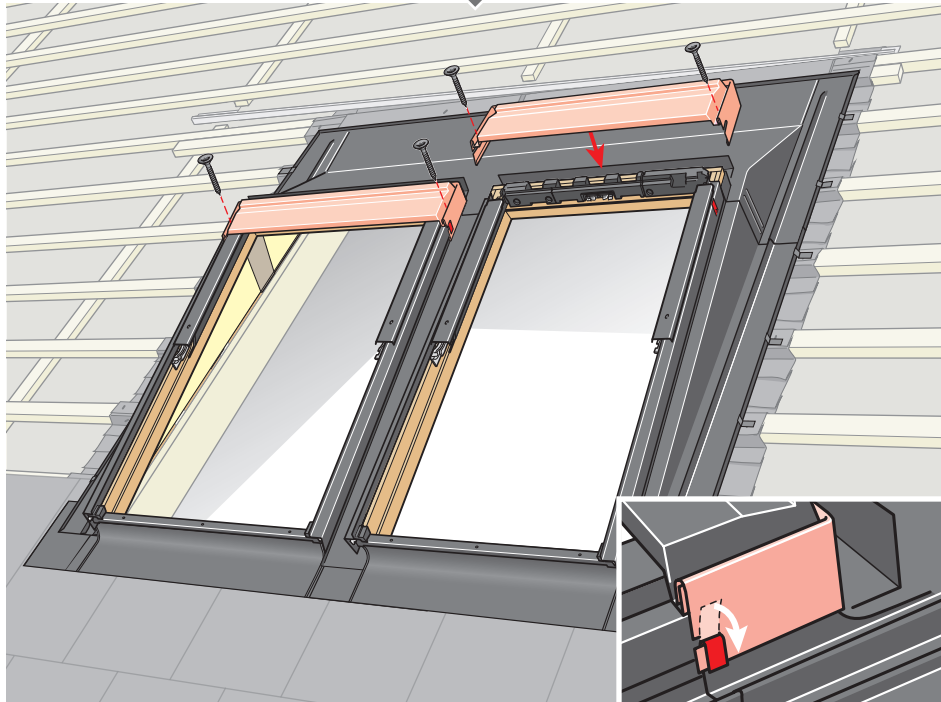
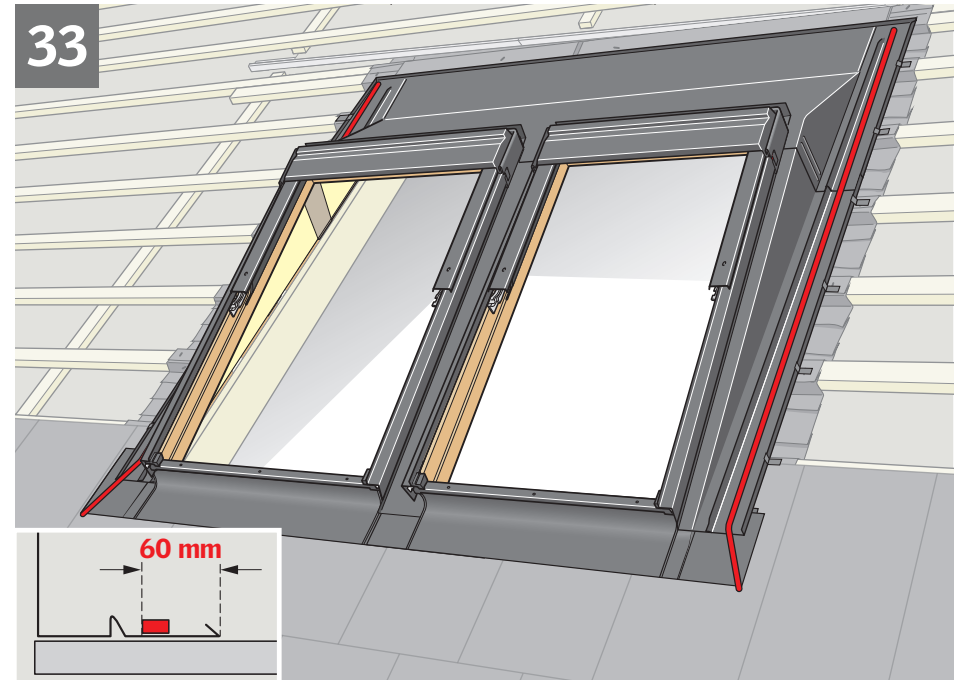

34

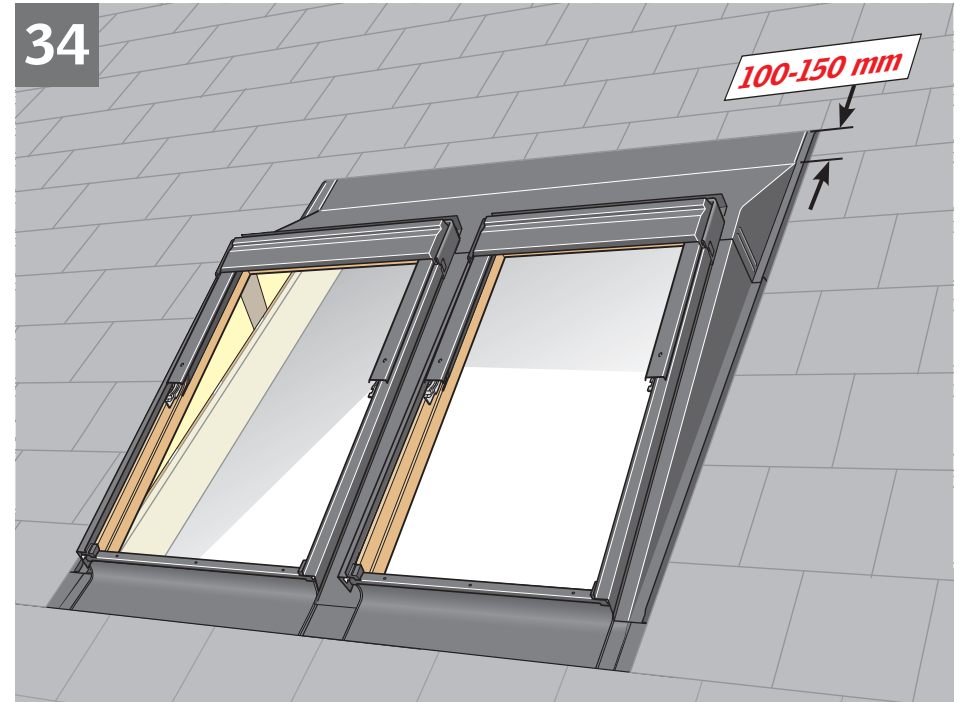



<b>AR:</b> VELUX Argentina S.A. 348 4 639944	<b>IE:</b> VELUX Company Ltd. 01 848 8775
<b>AT:</b> VELUX Österreich GmbH 02245/32 3 50	<b>IT:</b> VELUX Italia s.p.a. 045/6173666
<b>AU:</b> VELUX Australia Pty. Ltd. 1300 859 856	<b>JP:</b> VELUX-Japan Ltd. 0570-00-8145
<b>BA:</b> VELUX Bosna i Hercegovina d.o.o. 033/626 493, 626 494	<b>LT:</b> VELUX Lietuva, UAB (85) 270 91 01
<b>BE:</b> VELUX Belgium (010) 42.09.09	<b>LV:</b> VELUX Latvia SIA 67 27 77 33
<b>BG:</b> ВЕЛУКС България ЕООД 02/955 99 30	<b>NL:</b> VELUX Nederland B.V. 030 - 6 629 629
<b>BY:</b> Унитарное предприятие "ВЕЛЮКС Мансардные Окна" (017) 329 20 89	<b>NO:</b> VELUX Norge AS 22 51 06 00
<b>CA:</b> VELUX Canada Inc. 1 800 88-VELUX (888-3589)	<b>NZ:</b> VELUX New Zealand Ltd. 0800 650 445
<b>CH:</b> VELUX Schweiz AG 062 289 44 45	<b>PL:</b> VELUX Polska Sp. z o.o. (022) 33 77 000 / 33 77 070
<b>CL:</b> VELUX Chile Limitada 2 953 6789	<b>PT:</b> VELUX Portugal, Lda 21 880 00 60
<b>CN:</b> VELUX (CHINA) CO. LTD. 0316-607 27 27	<b>RO:</b> VELUX România S.R.L. 0-8008-83589
<b>CZ:</b> VELUX Česká republika, s.r.o. 531 015 511	<b>RS:</b> VELUX Srbija d.o.o. 011 20 57 500
<b>DE:</b> VELUX Deutschland GmbH 040 / 54 70 70	<b>RU:</b> ЗАО ВЕЛЮКС (495) 640 87 20
<b>DK:</b> VELUX Danmark A/S 45 16 45 16	<b>SE:</b> VELUX Svenska AB 042/20 83 80
<b>EE:</b> VELUX Eesti OÜ 621 7790	<b>SI:</b> VELUX Slovenija d.o.o. 01 724 68 68
<b>ES:</b> VELUX Spain, S.A. 91 509 71 00	<b>SK:</b> VELUX Slovensko, s.r.o. (02) 33 000 555
<b>FI:</b> VELUX Suomi Oy 0207 290 800	<b>TR:</b> VELUX Çatı Pencereleri Ticaret Limited Şirketi 0 216 302 54 10
<b>FR:</b> VELUX France 0821 02 15 15 0,119€ TTC/min	<b>UA:</b> ТОВ "ВЕЛЮКС Україна" (044) 2916070
<b>GB:</b> VELUX Company Ltd. 01592 778 225	<b>US:</b> VELUX America LLC 1-800-88-VELUX
<b>HR:</b> VELUX Hrvatska d.o.o. 01/5555 444	
<b>HU:</b> VELUX Magyarország Kft. (06/1) 436-0601	