

VELUX®

EBW/EBL/EBS --22BA

GIL/GIU + EBY W35 + BDX + BFX

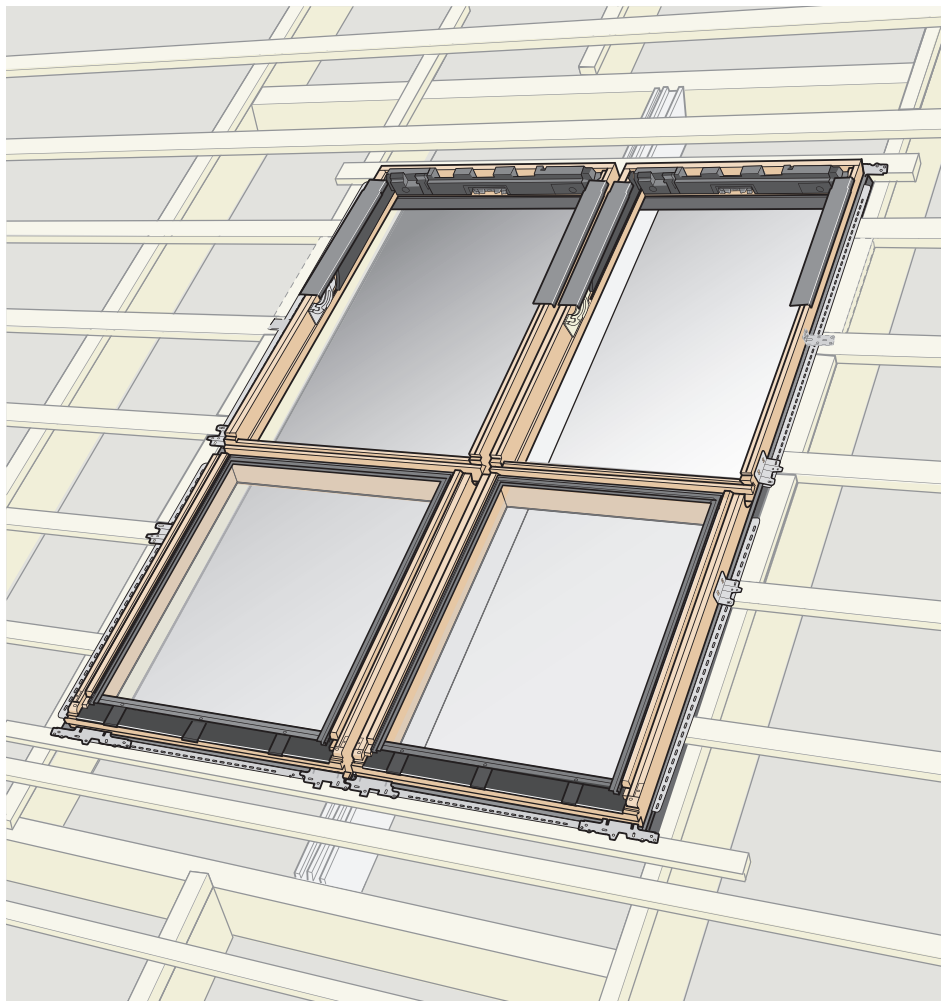

VAS 454183-2017-07

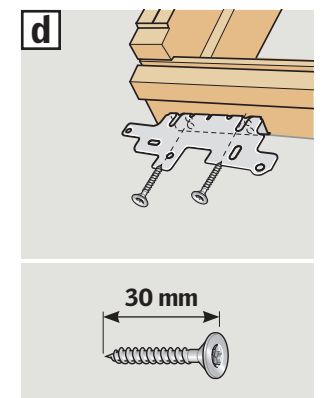
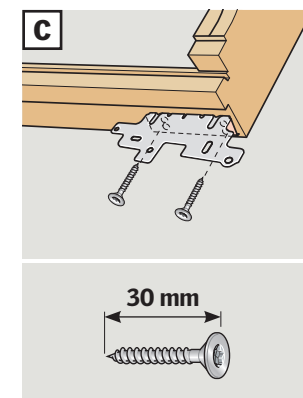
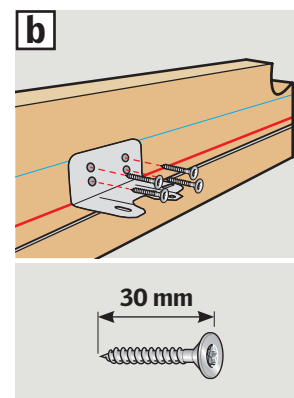
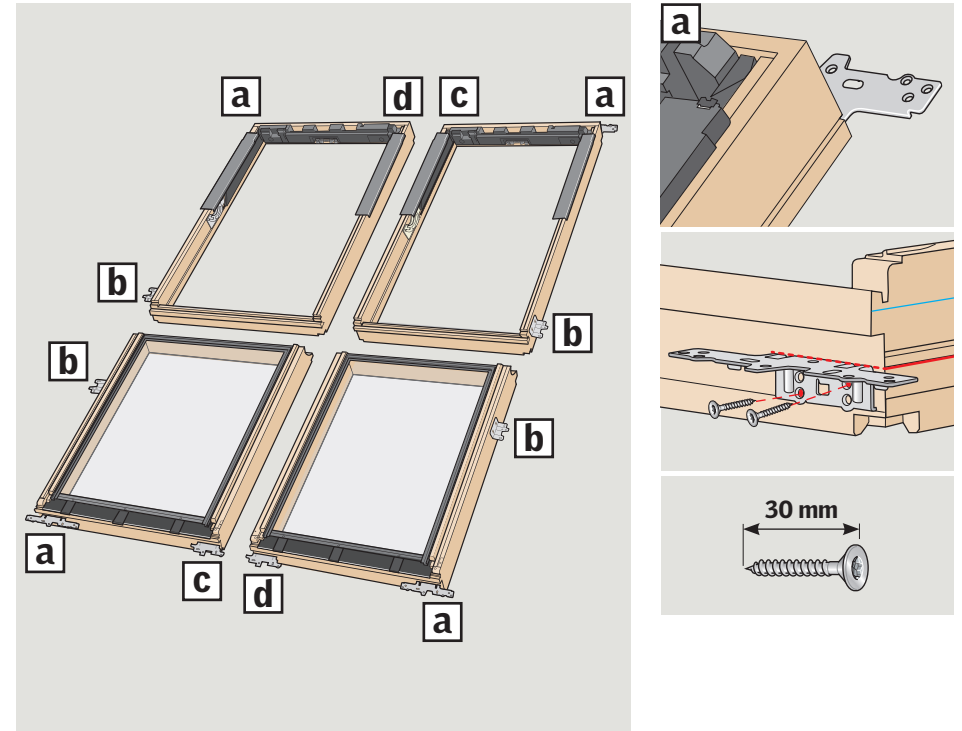
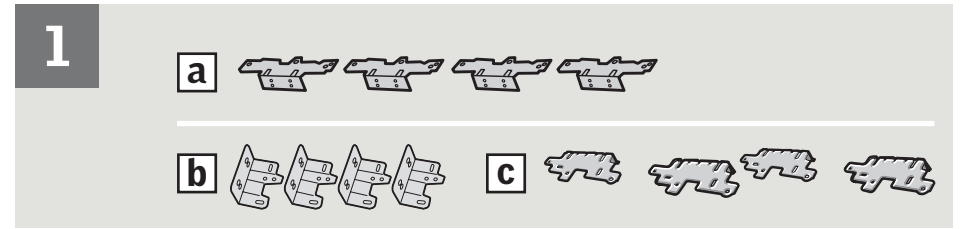
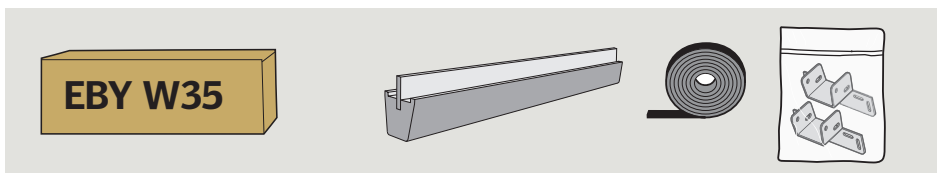
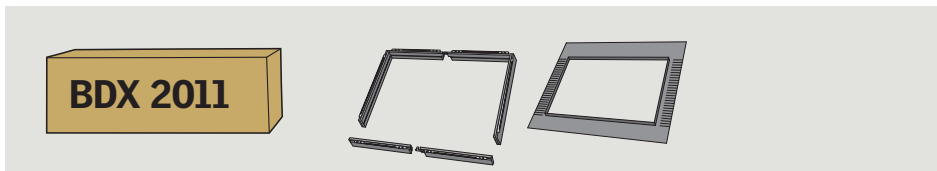
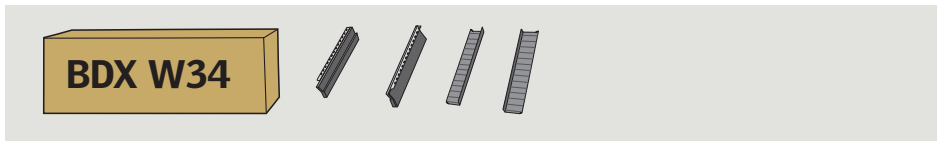
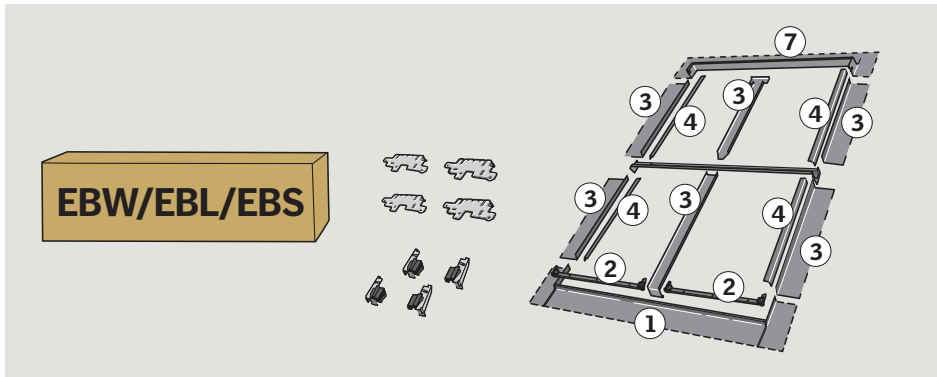
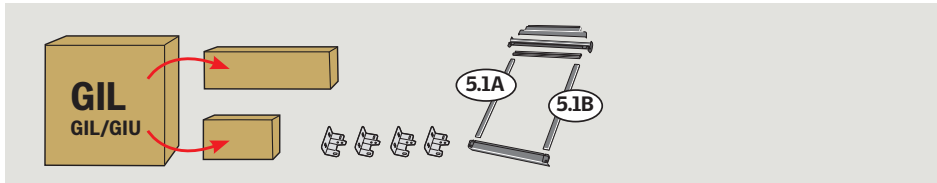
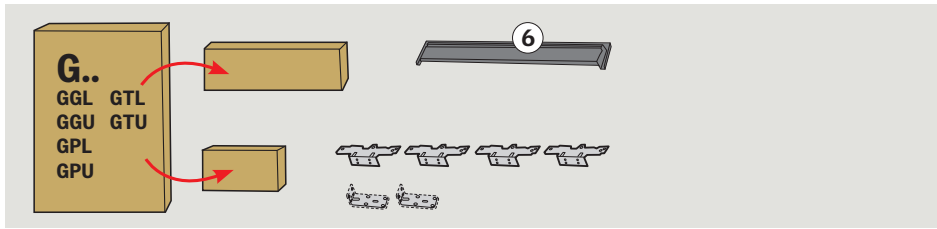

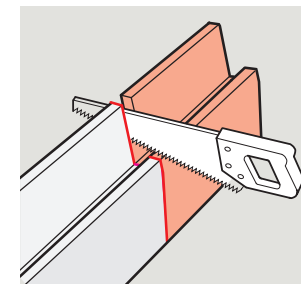
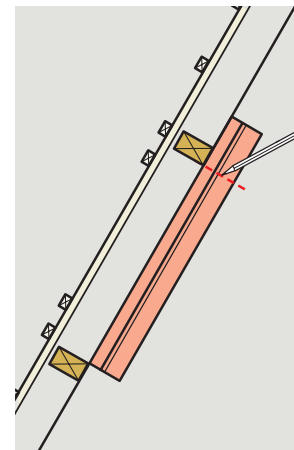
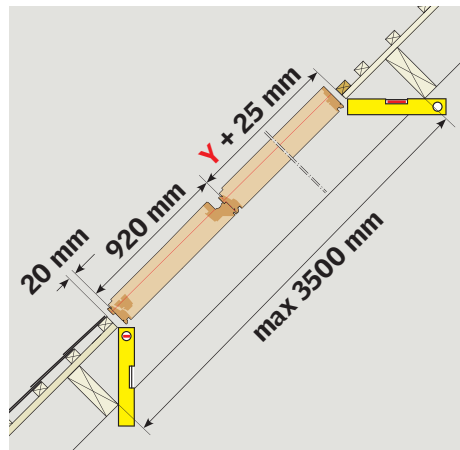
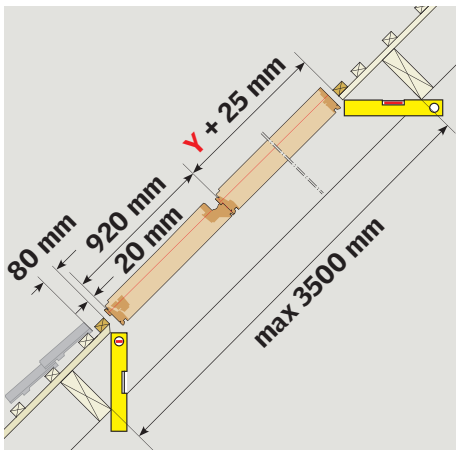
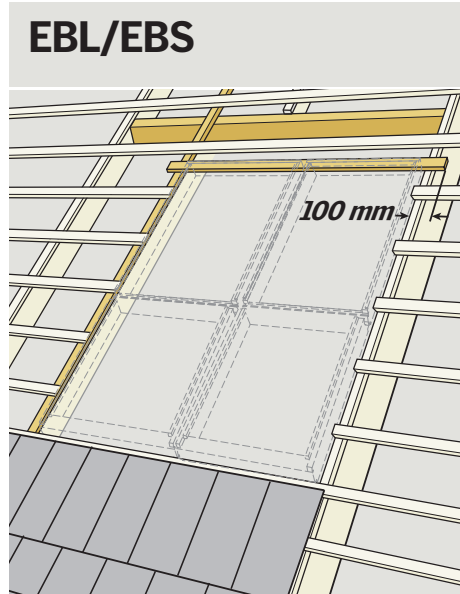
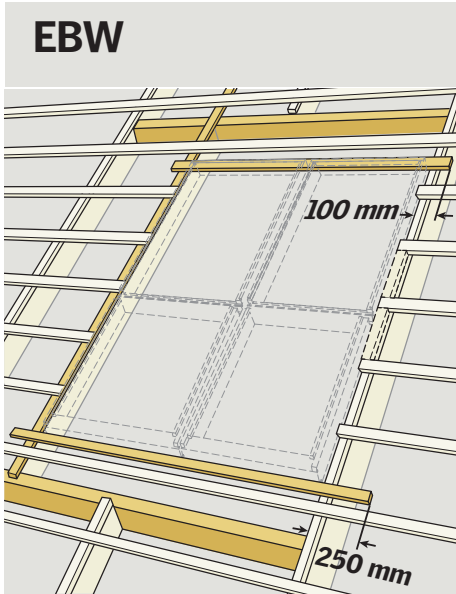
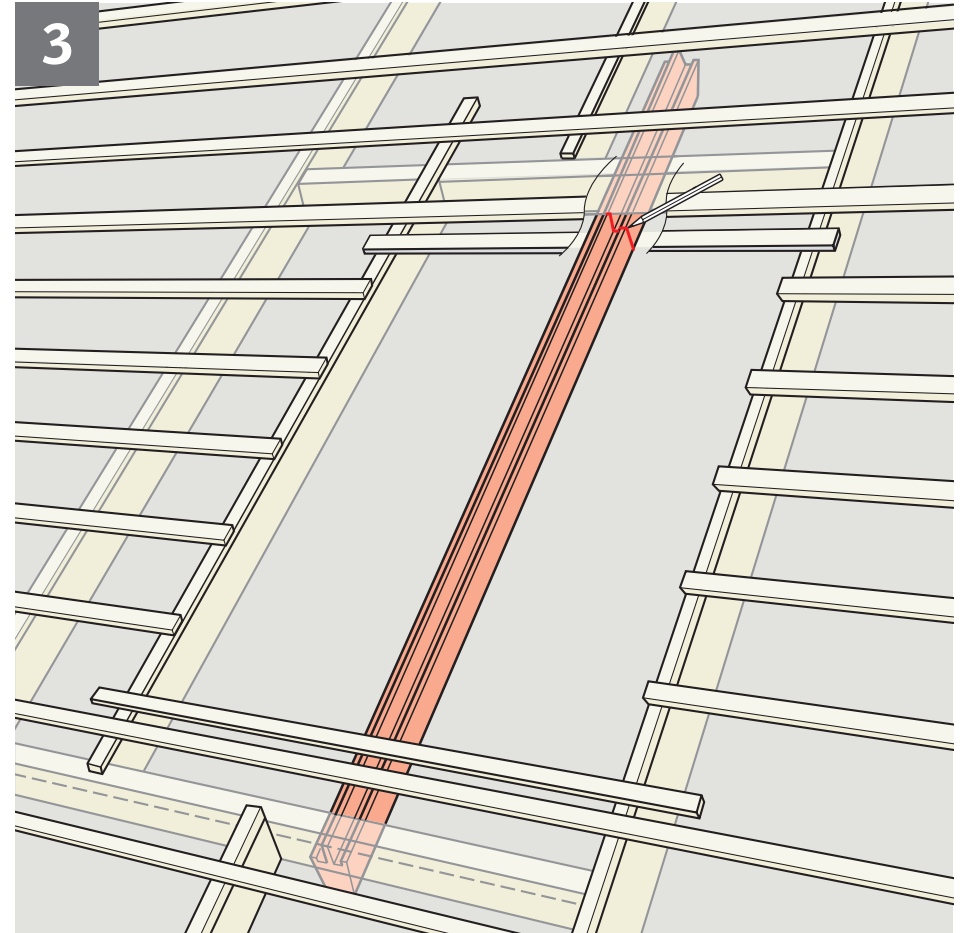
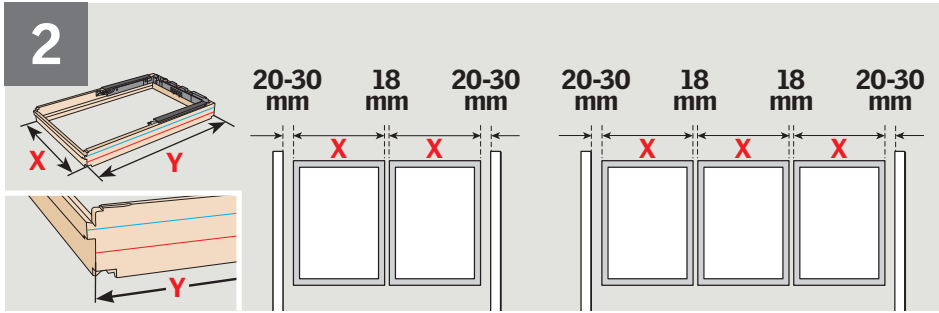

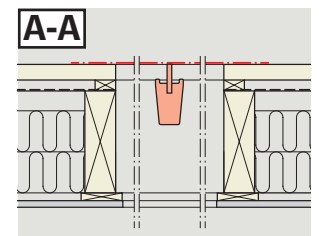
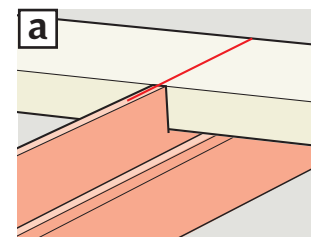
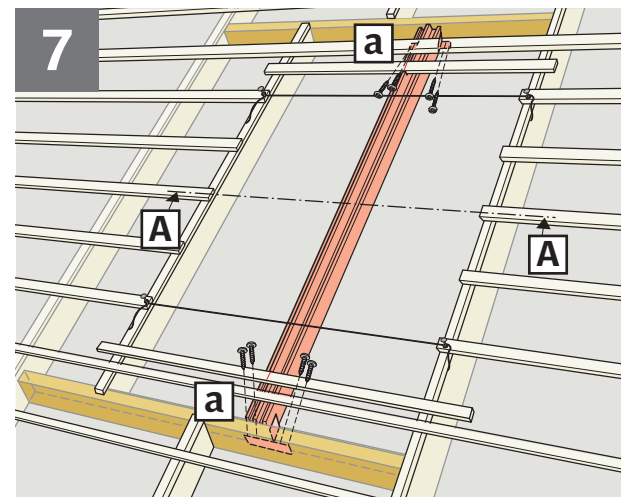
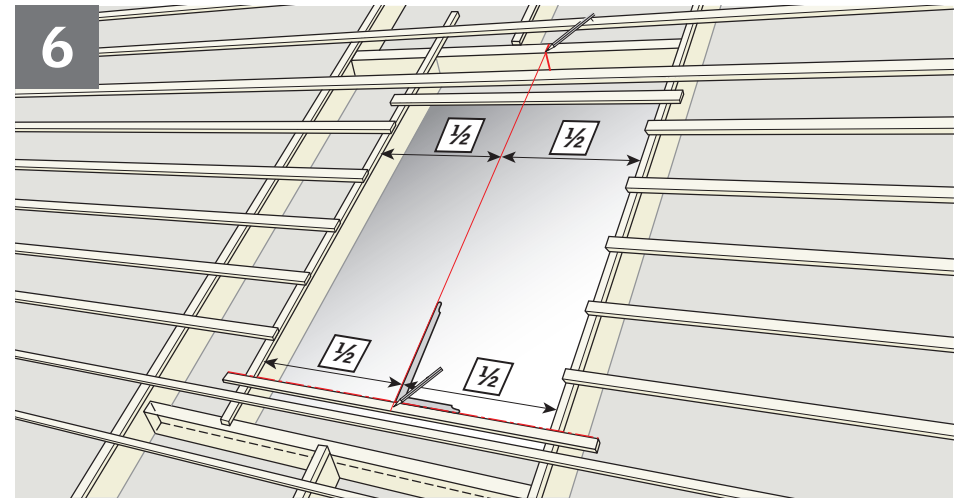
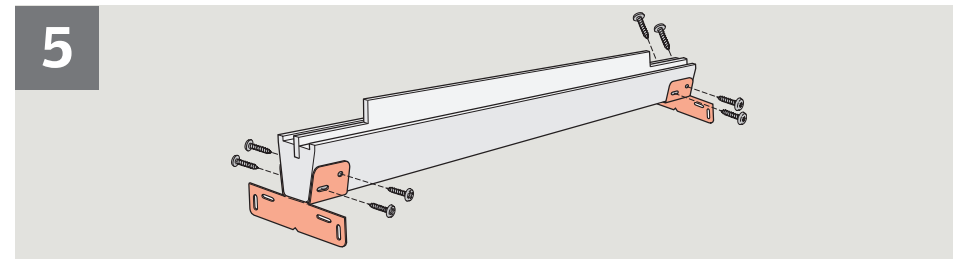
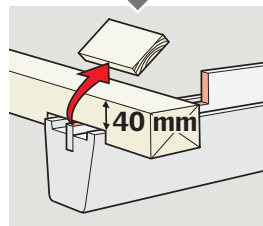
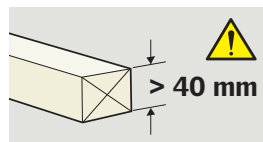
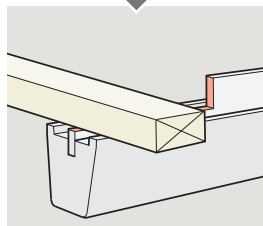
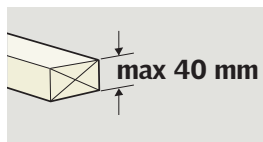
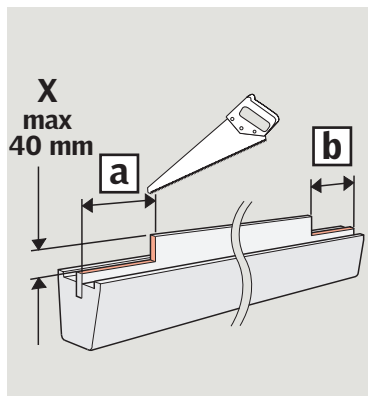
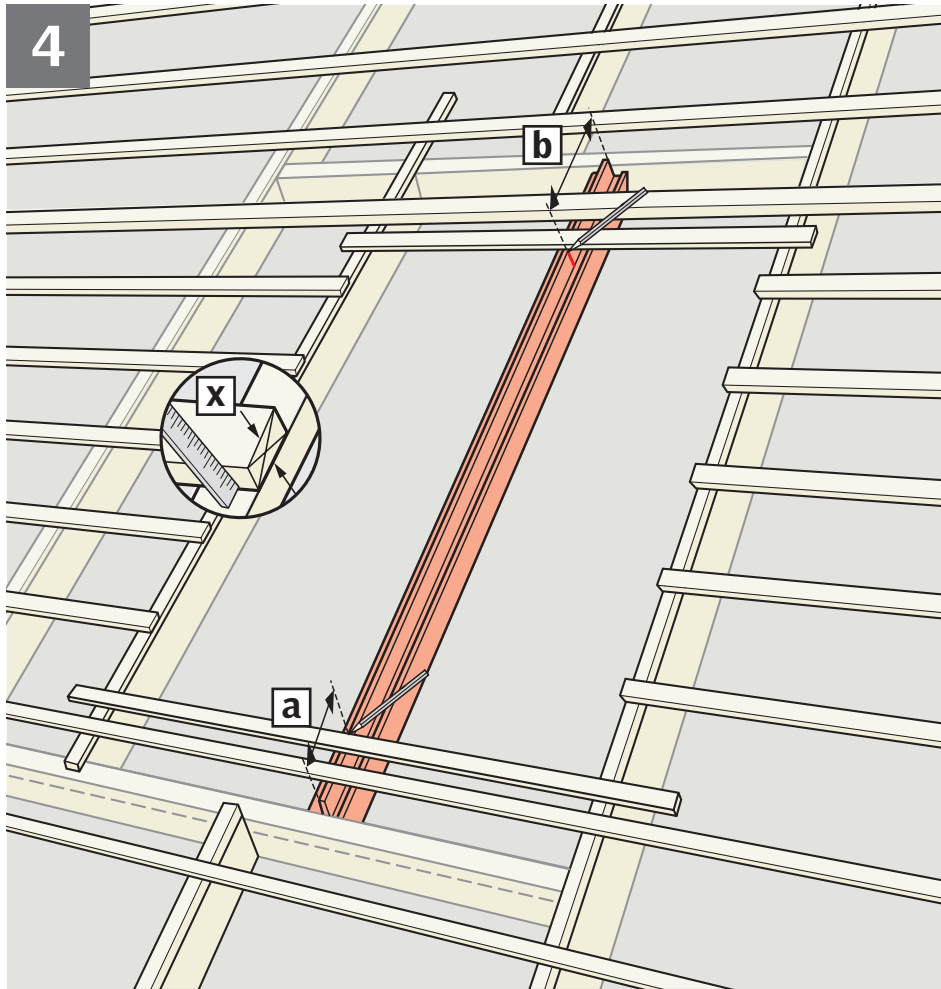

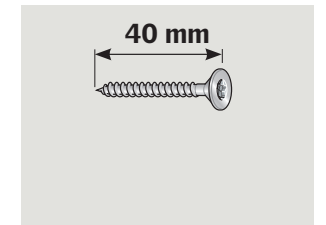
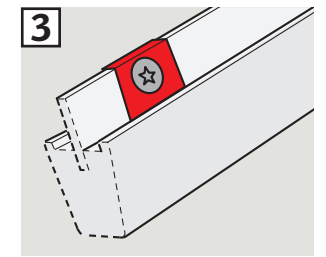
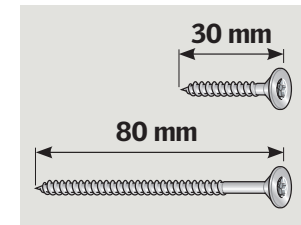
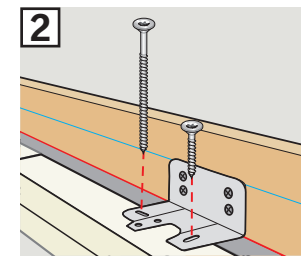
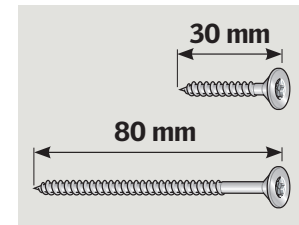
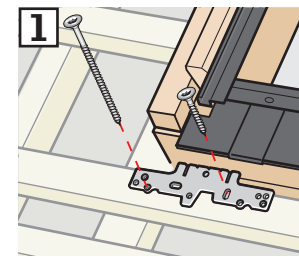
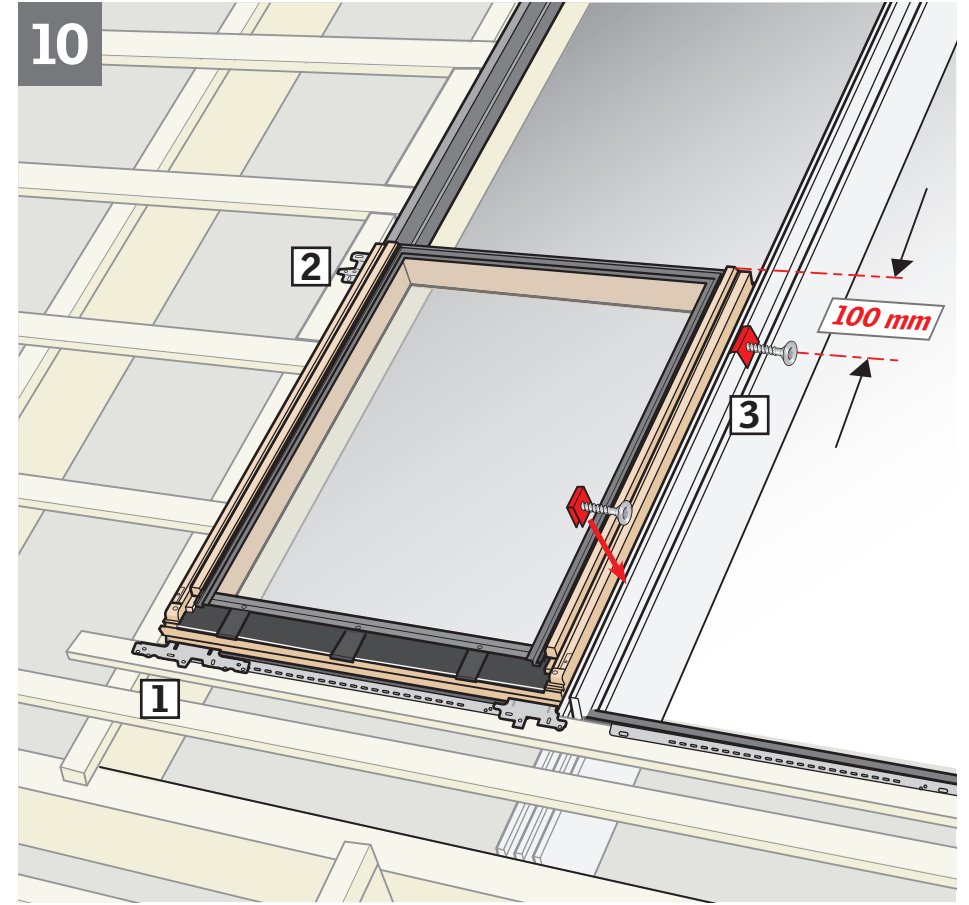
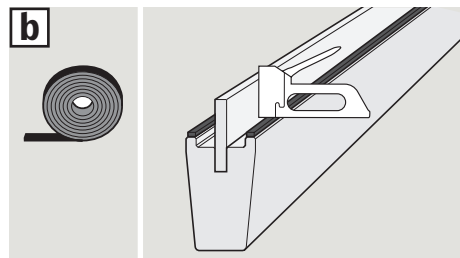
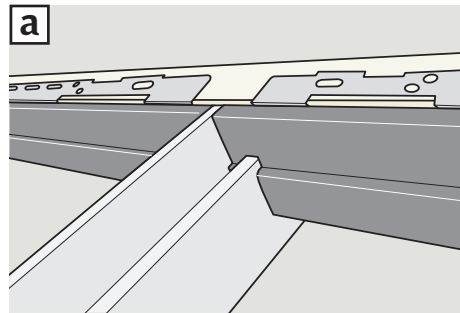
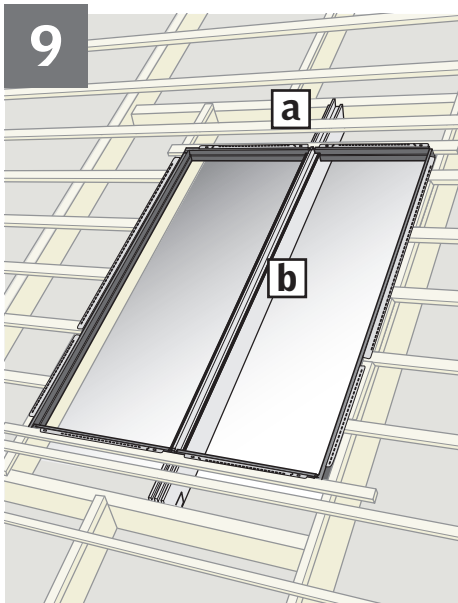
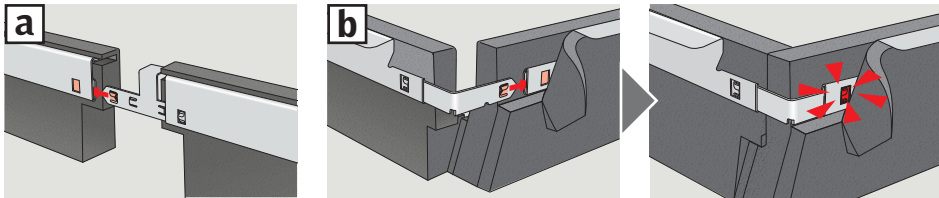
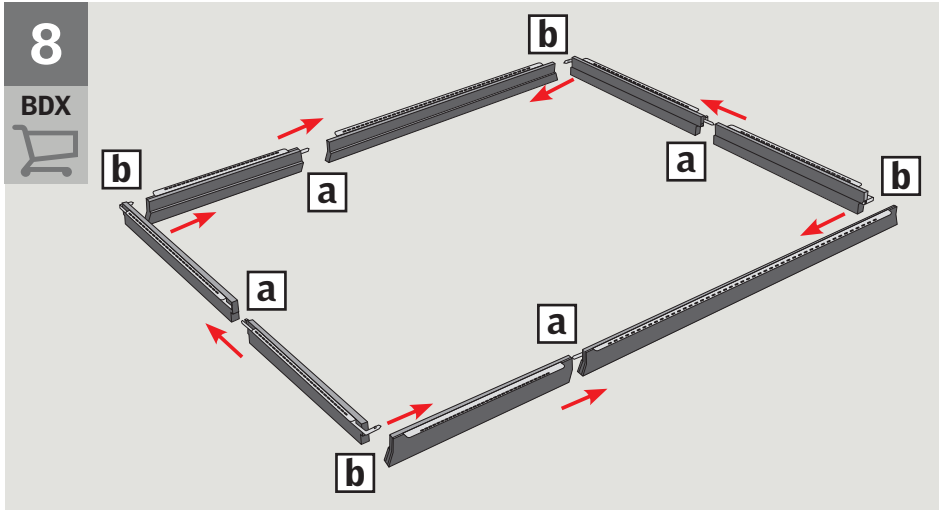

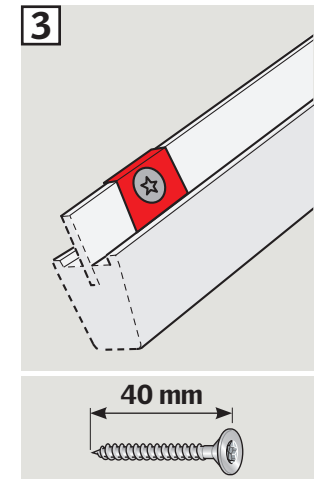
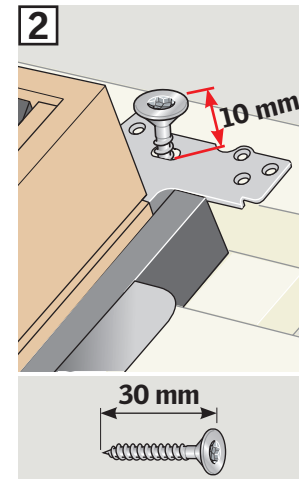
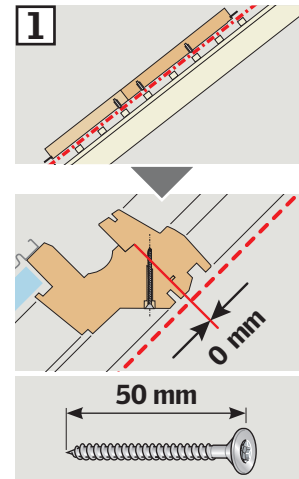
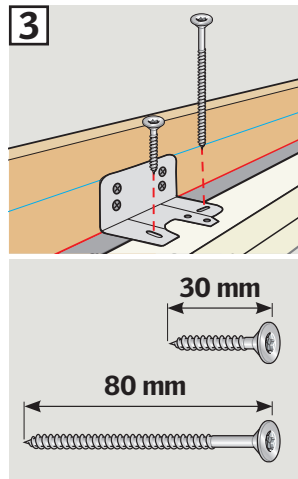
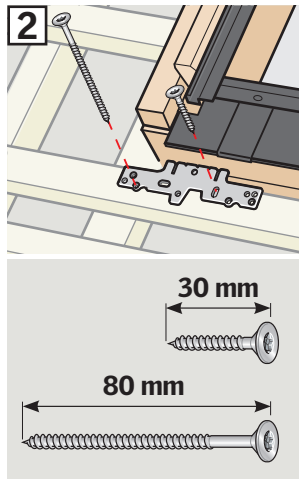
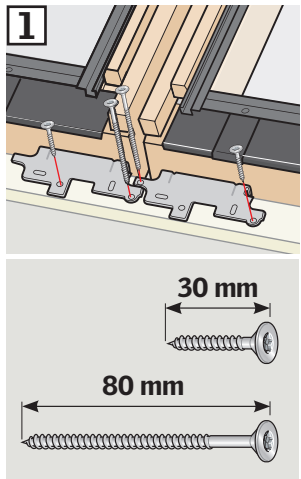
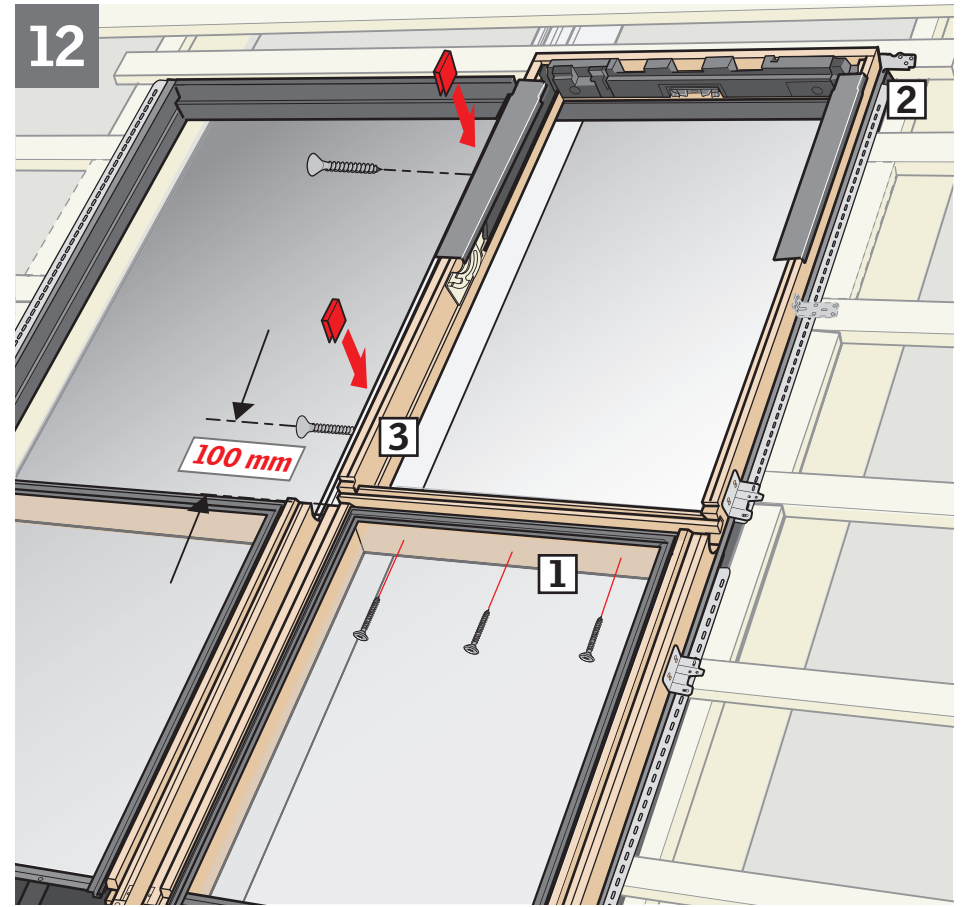
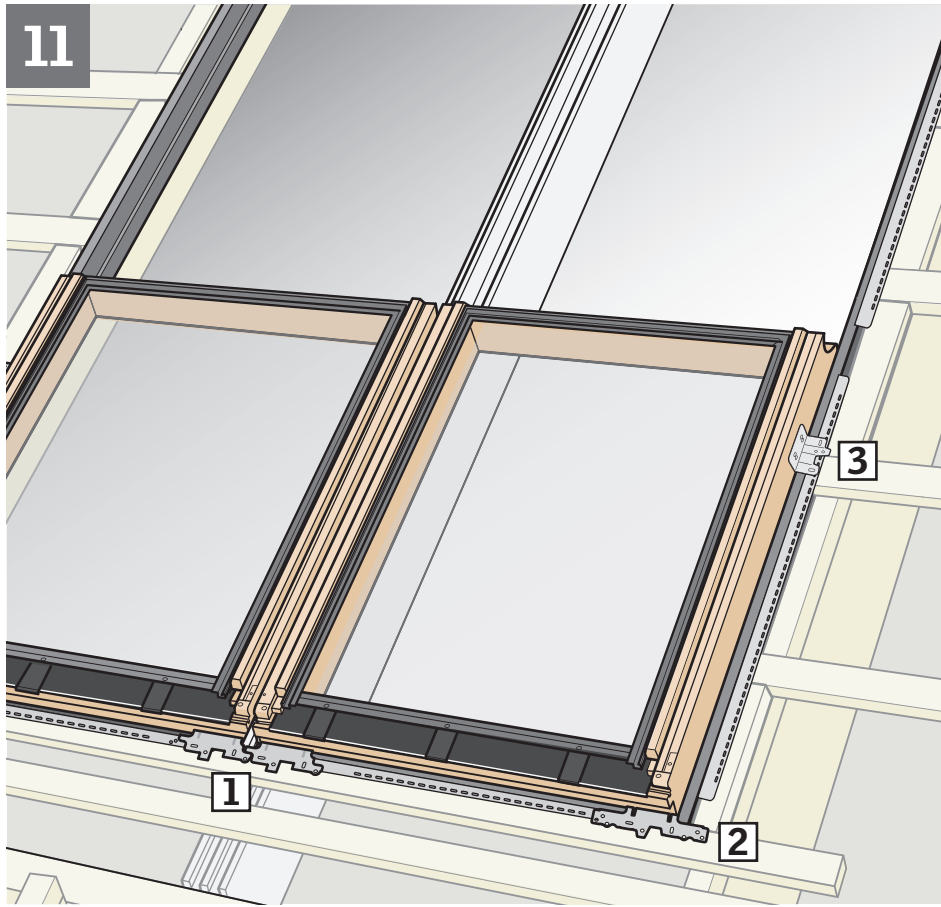

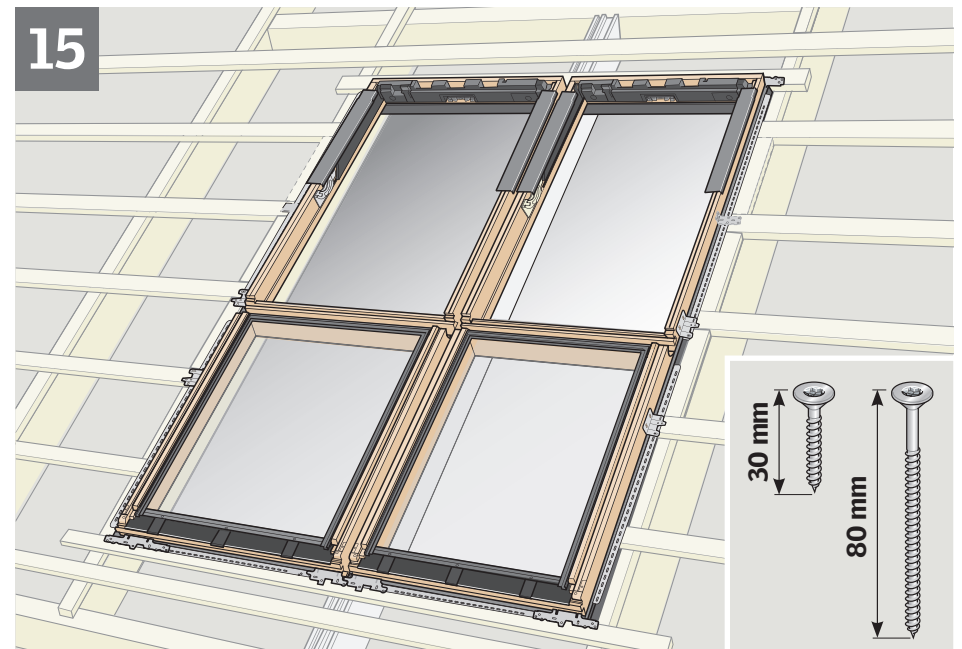
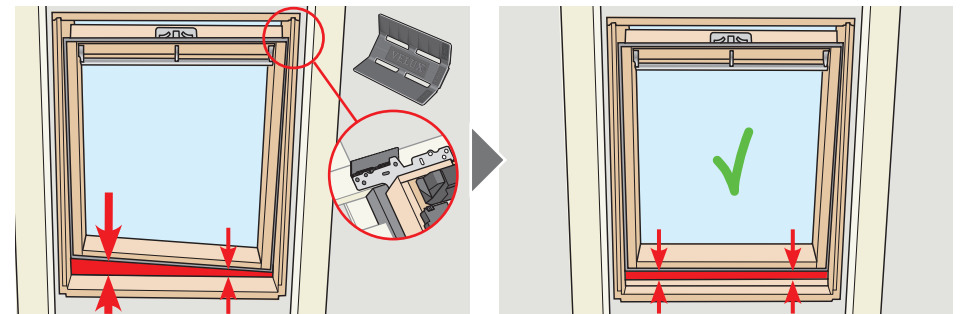
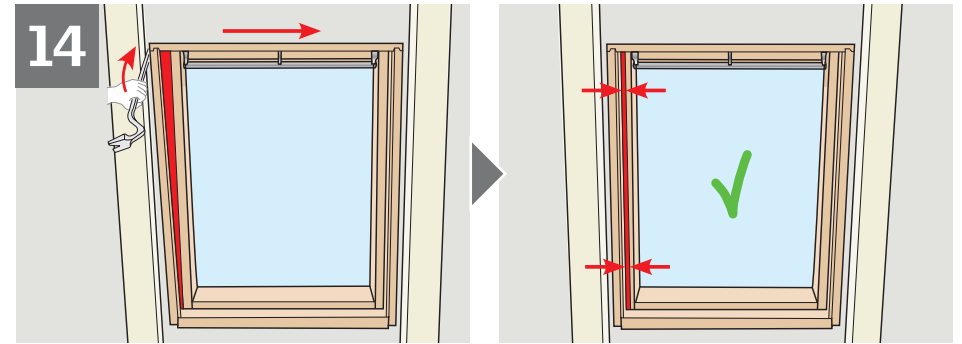
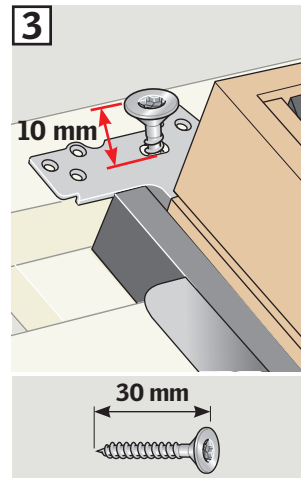
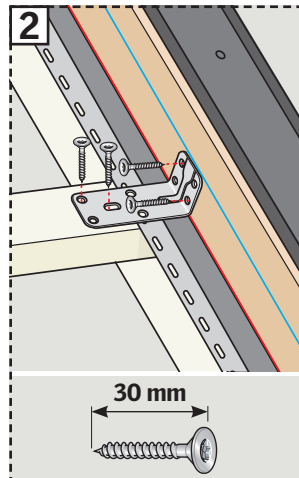
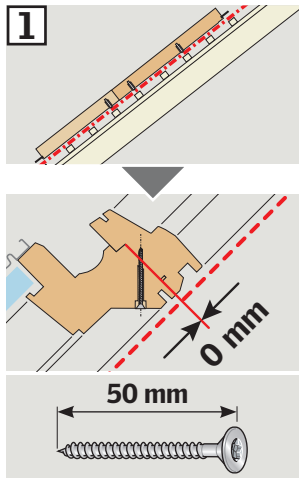
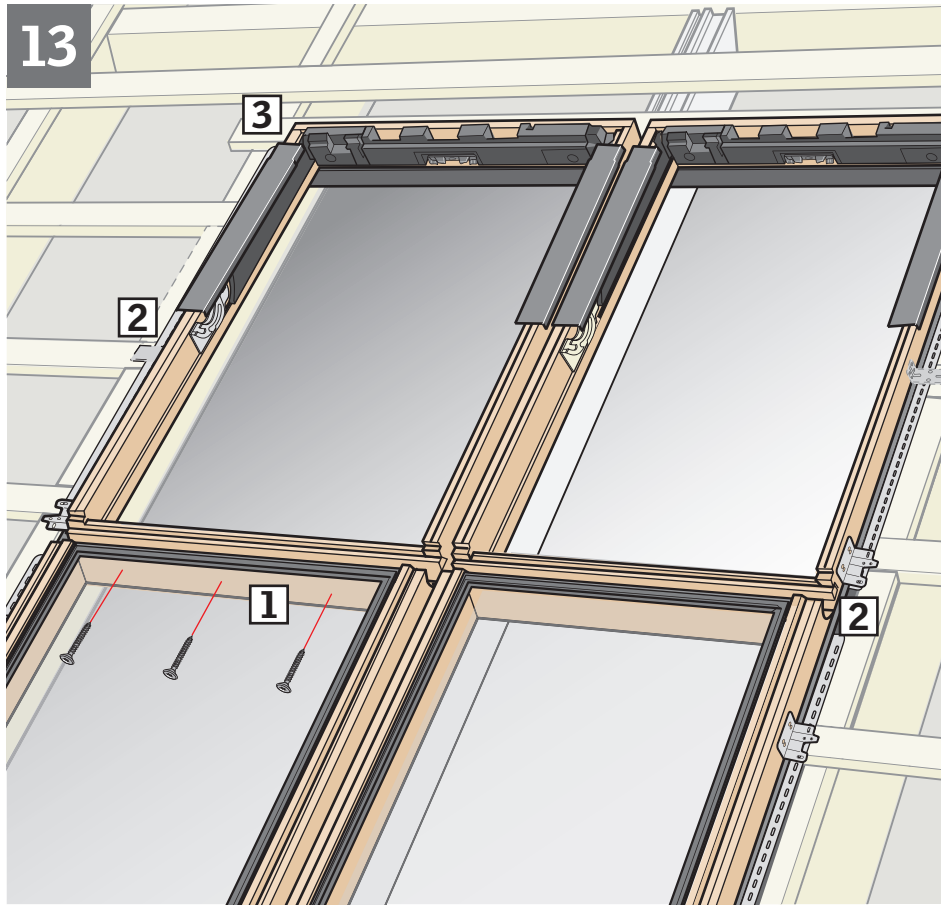

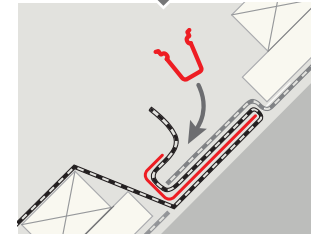
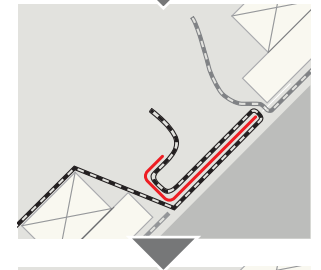
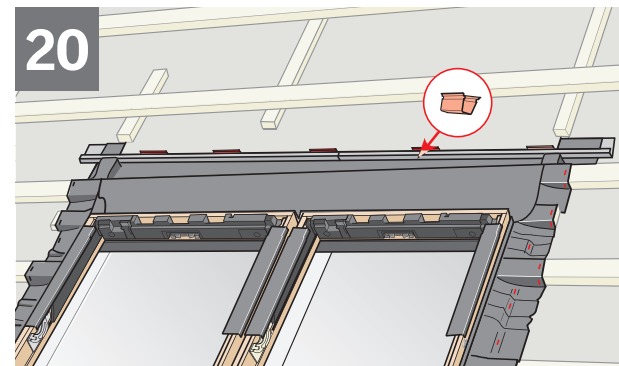
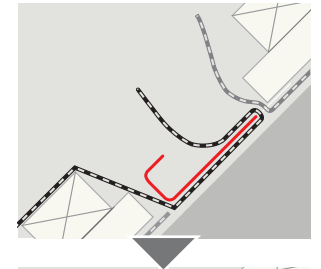
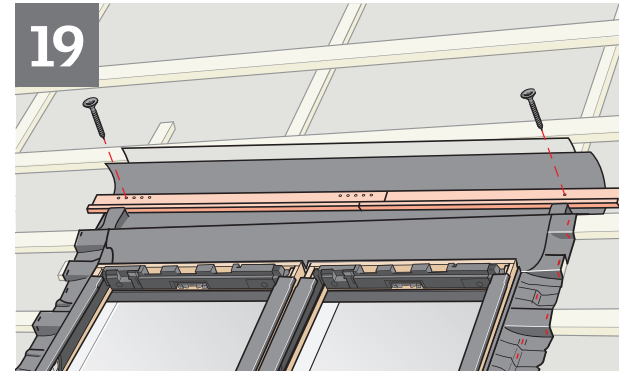
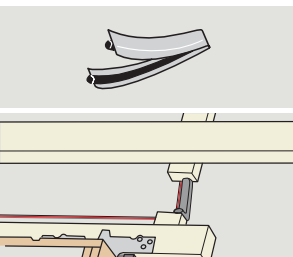
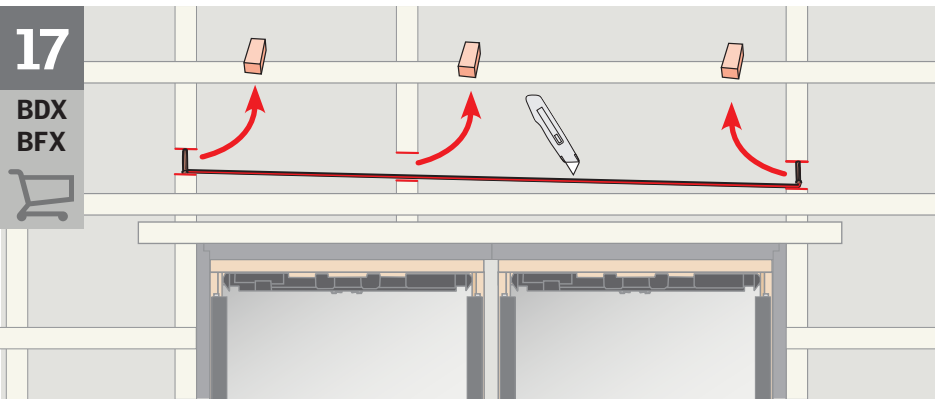
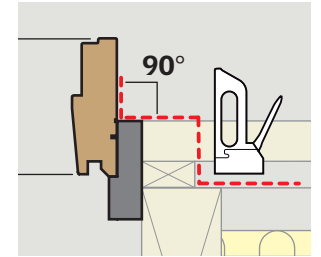
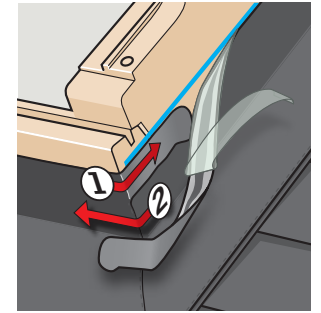
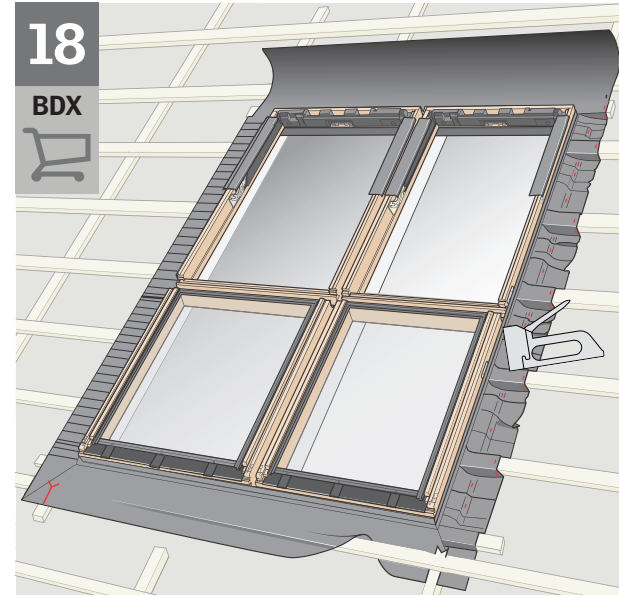
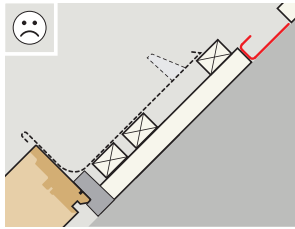
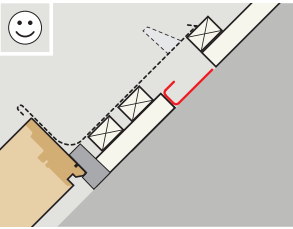
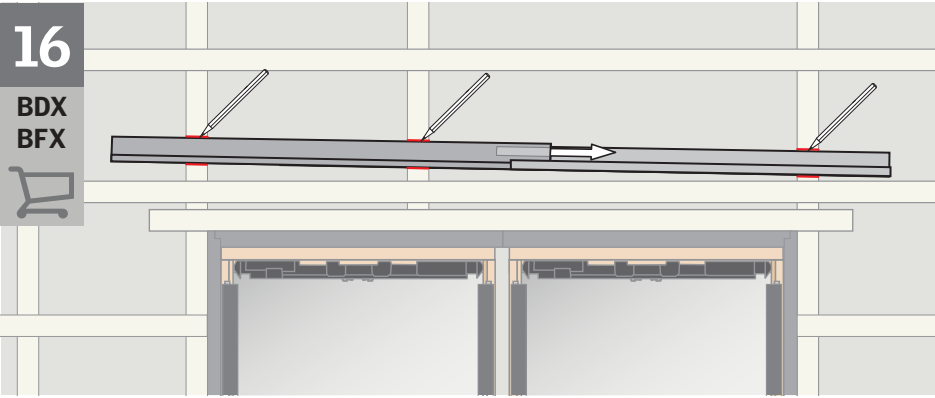

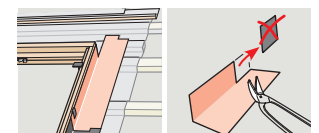
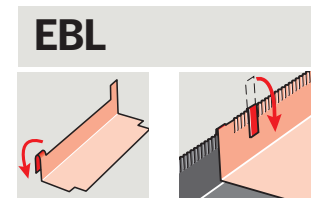
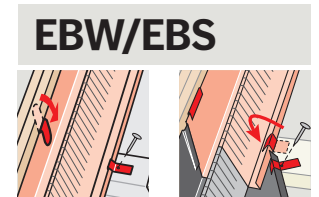
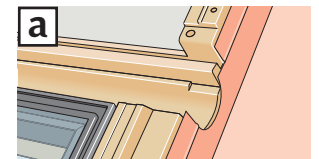
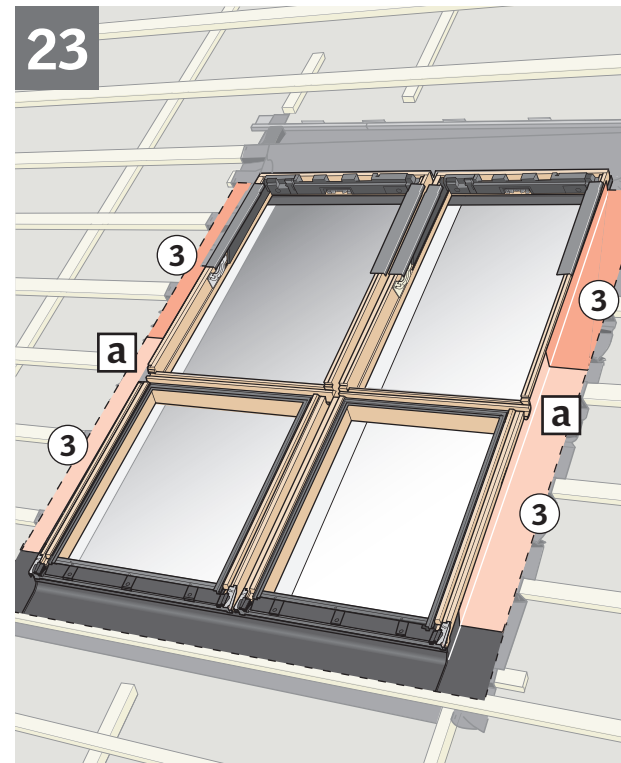
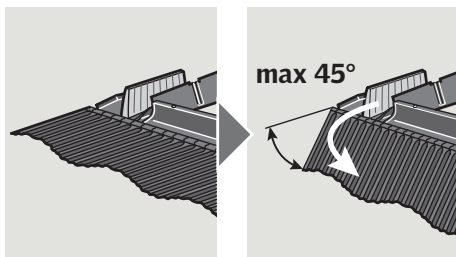
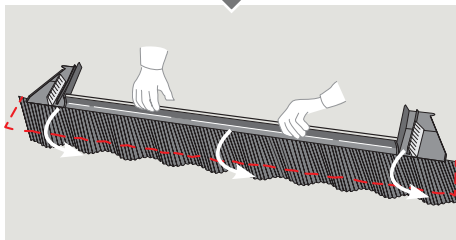
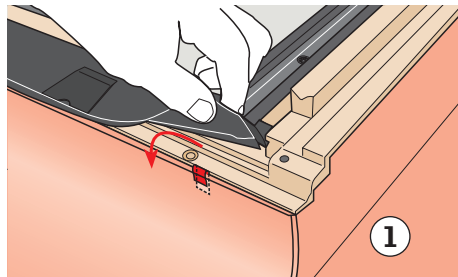
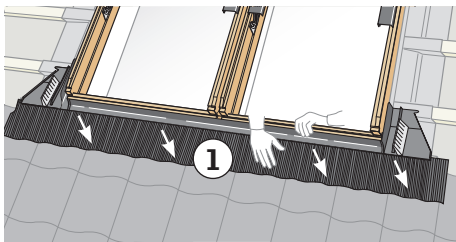
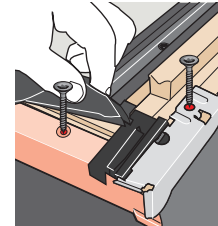
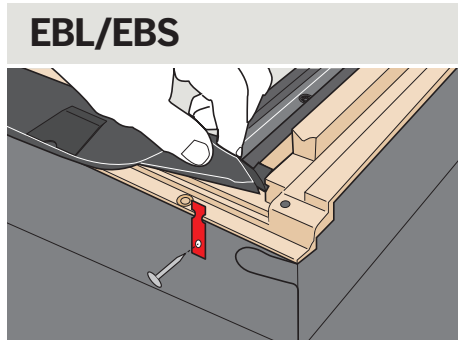
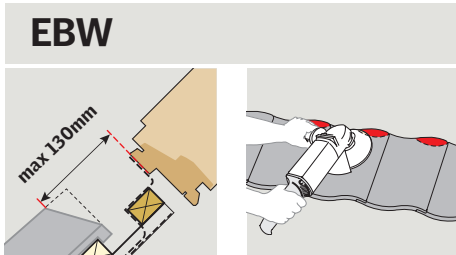
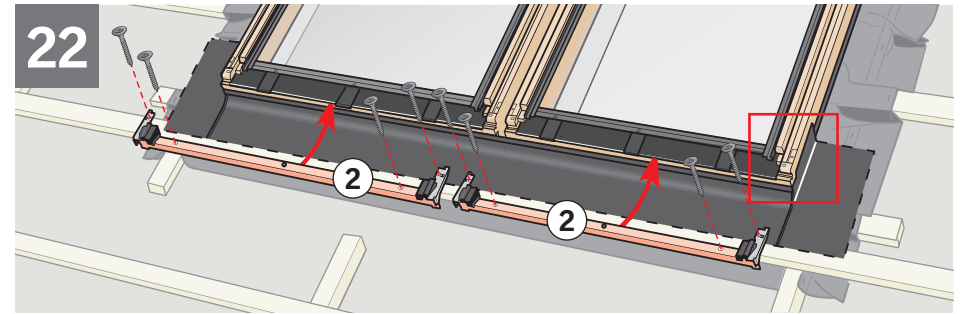
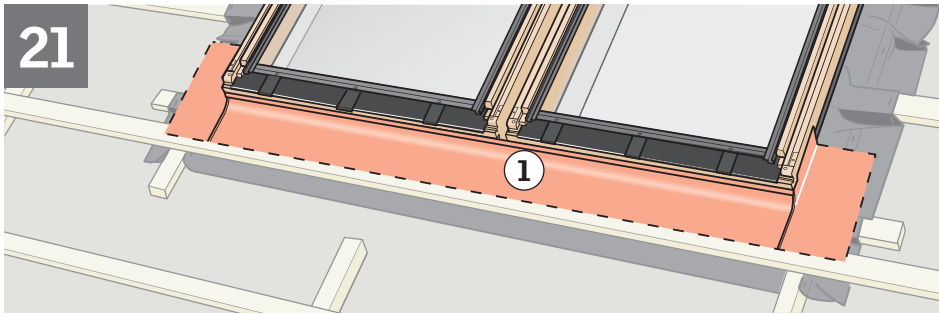

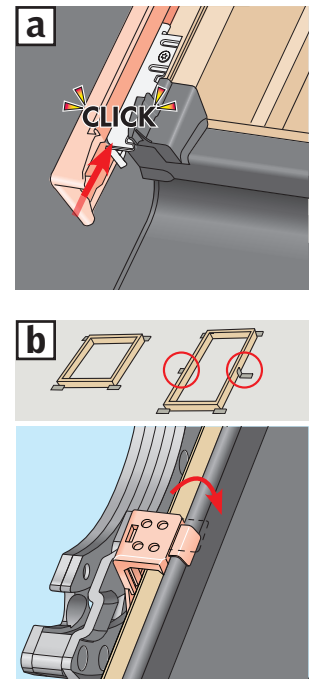
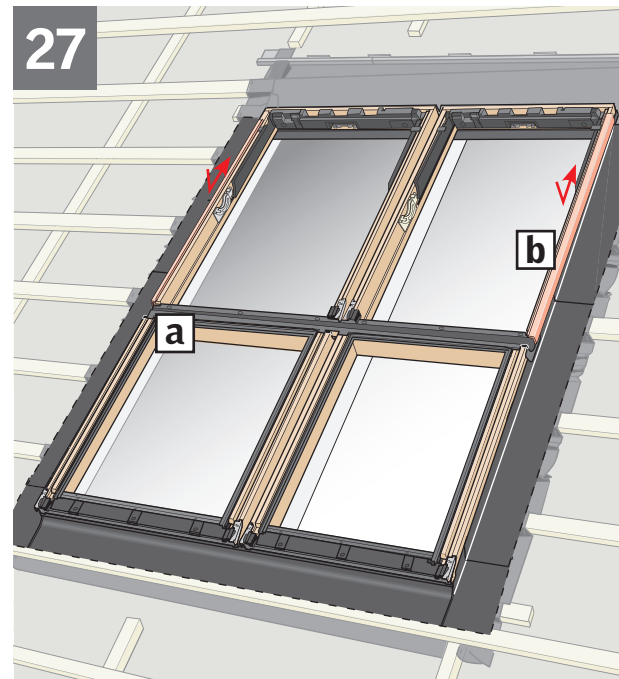
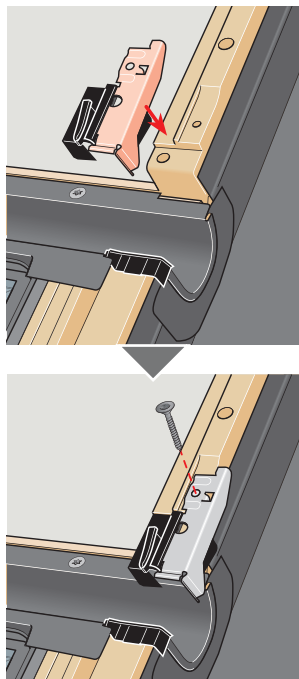
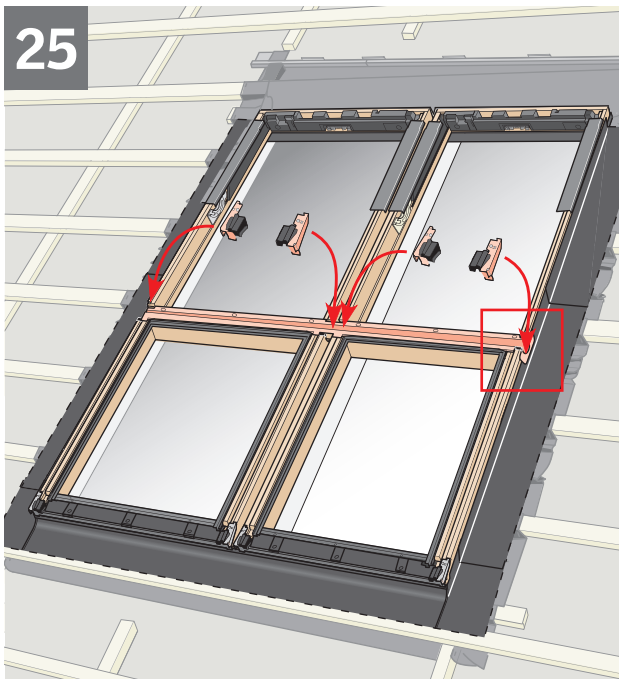
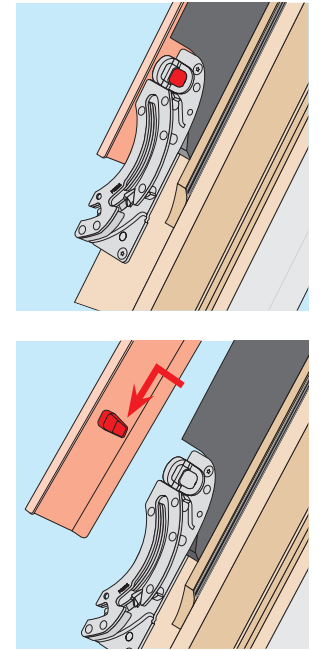
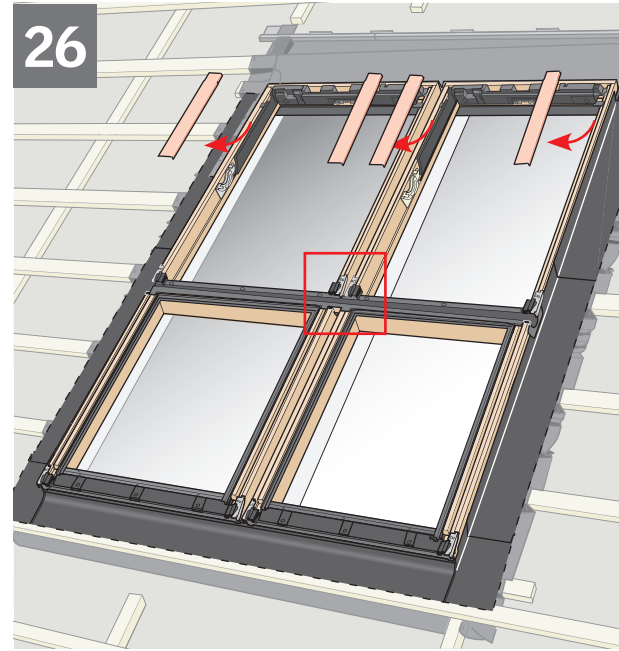
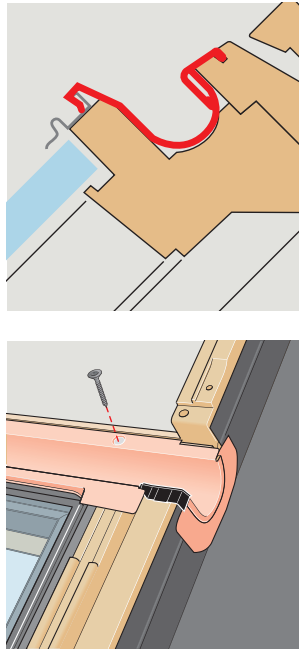
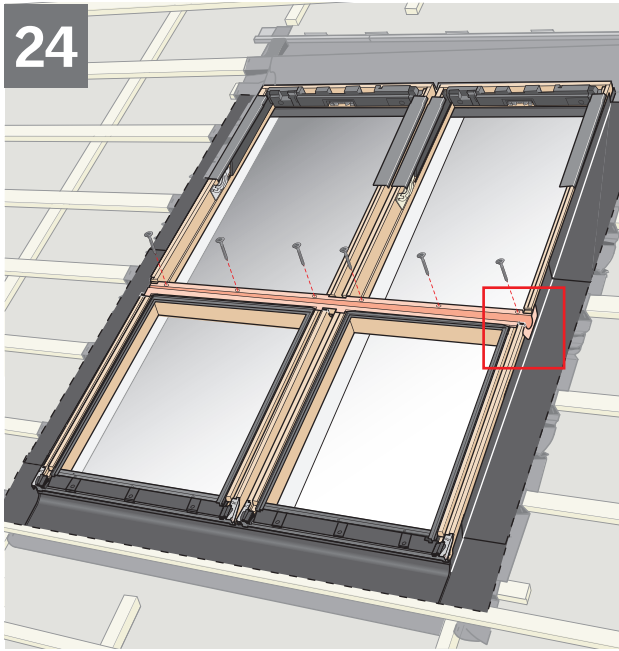

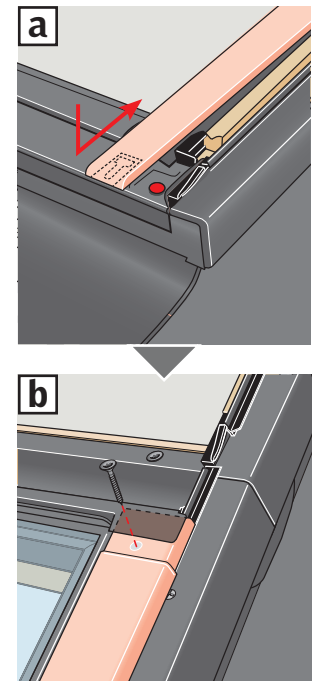
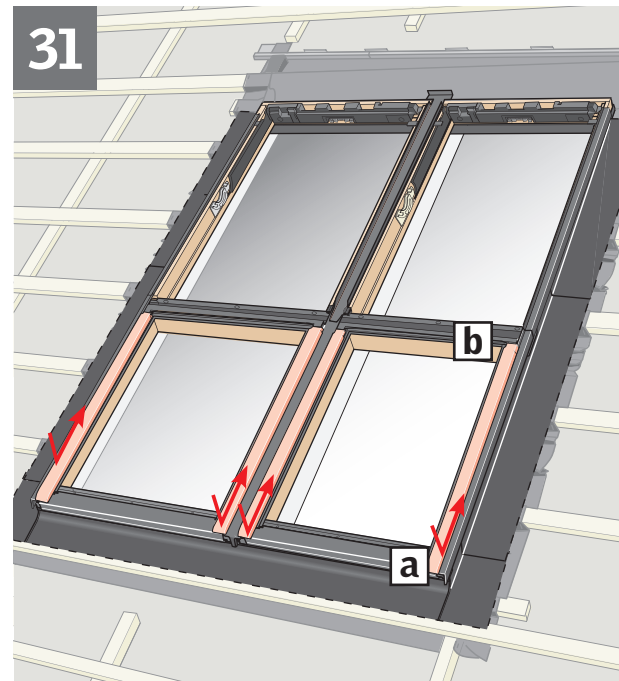
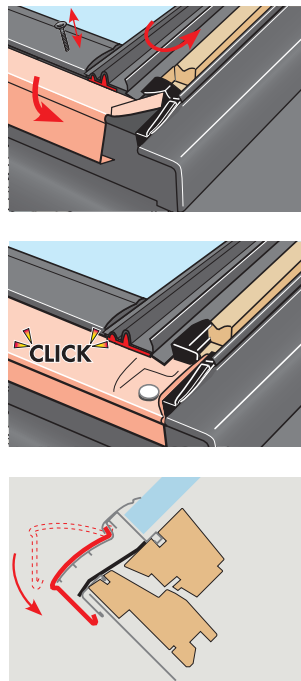
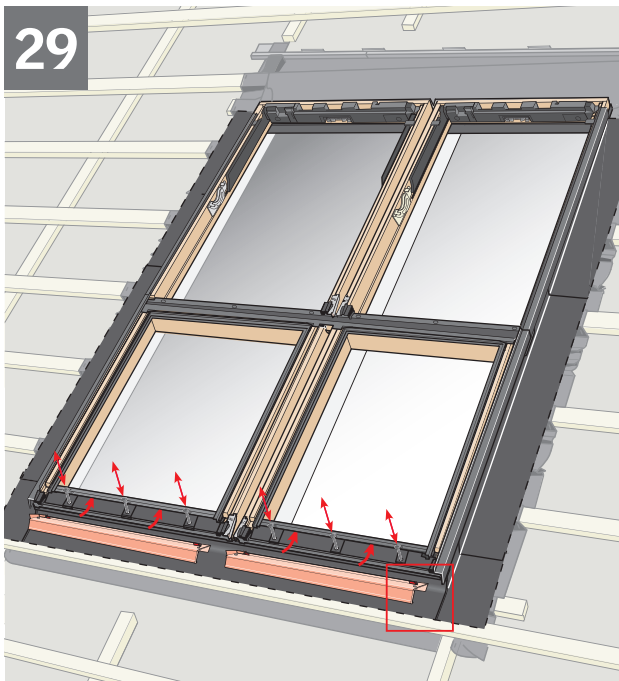
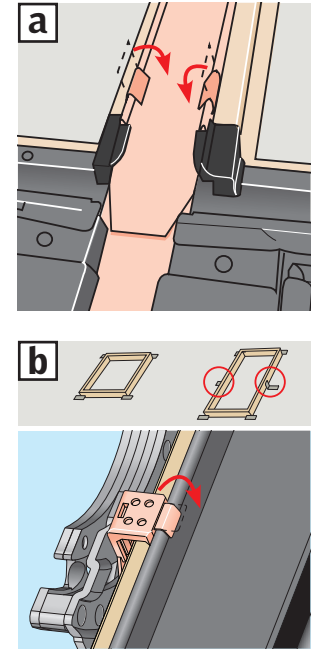
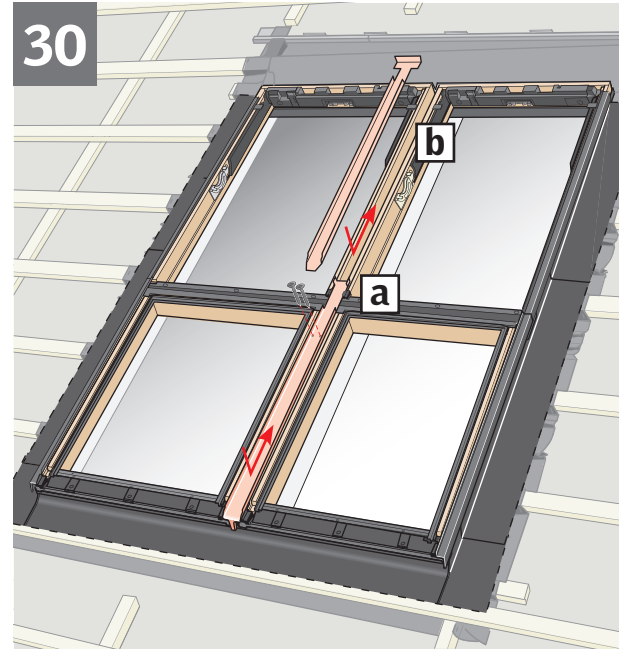
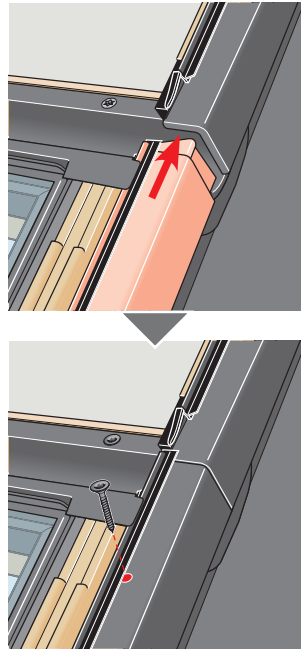
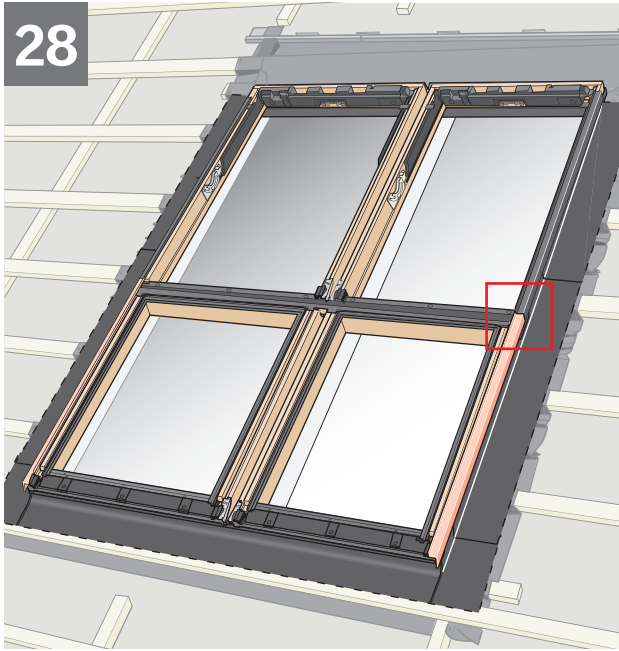

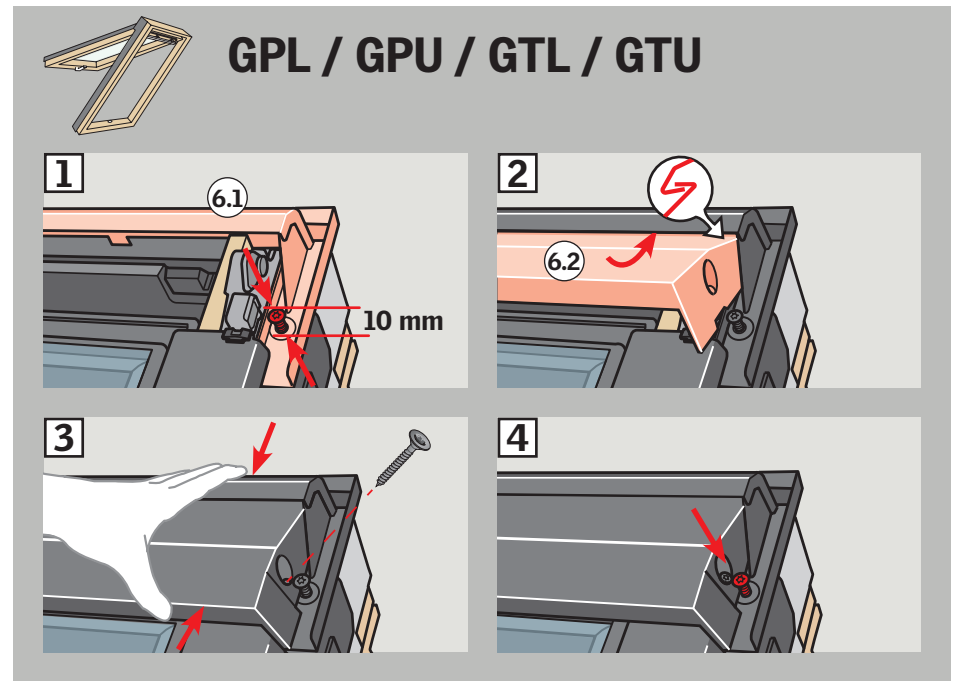
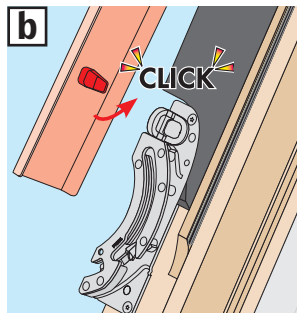
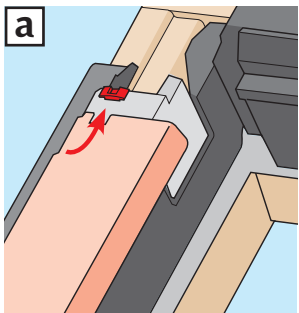
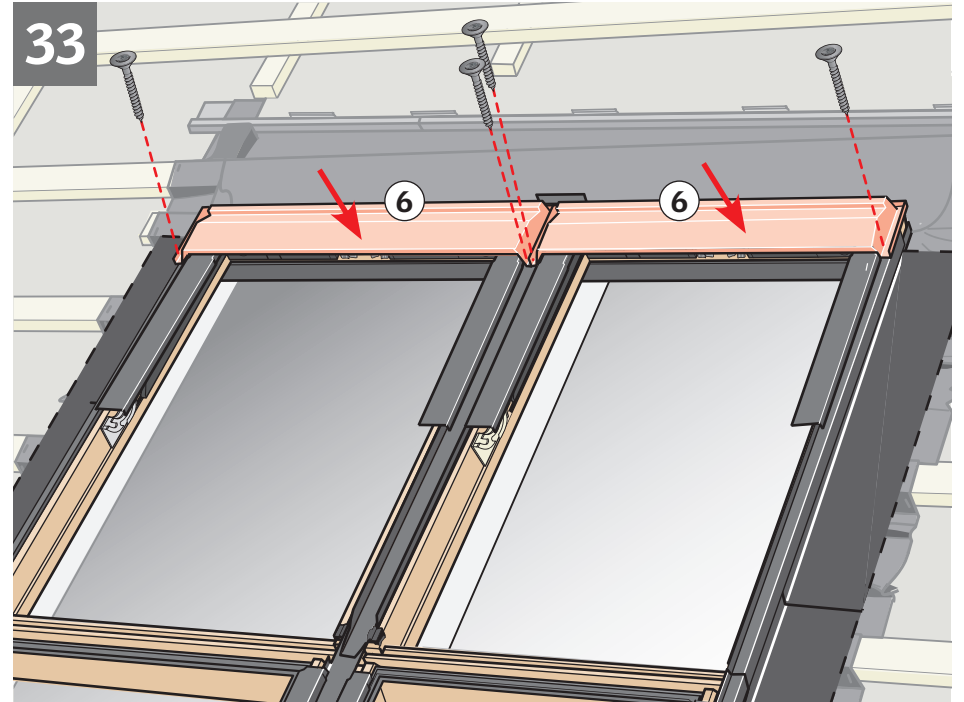
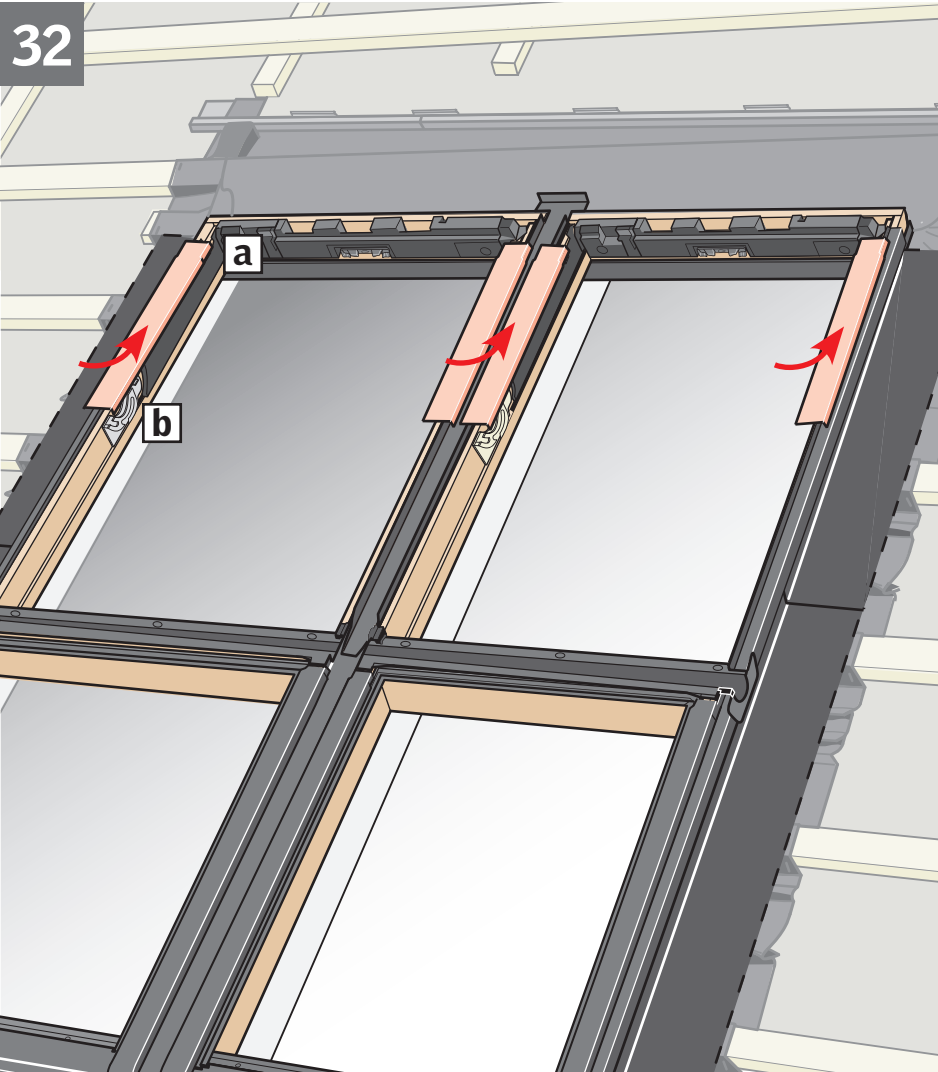

34

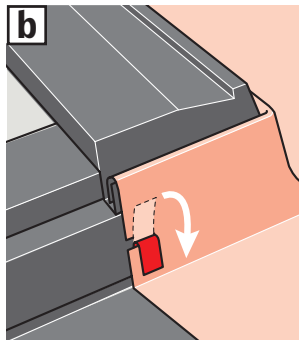
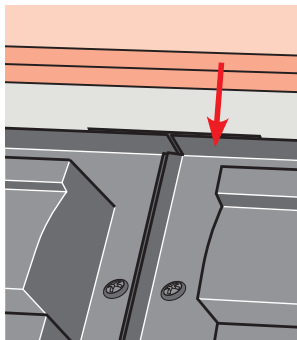
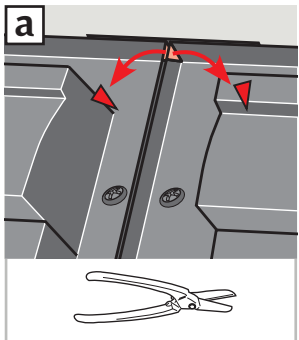
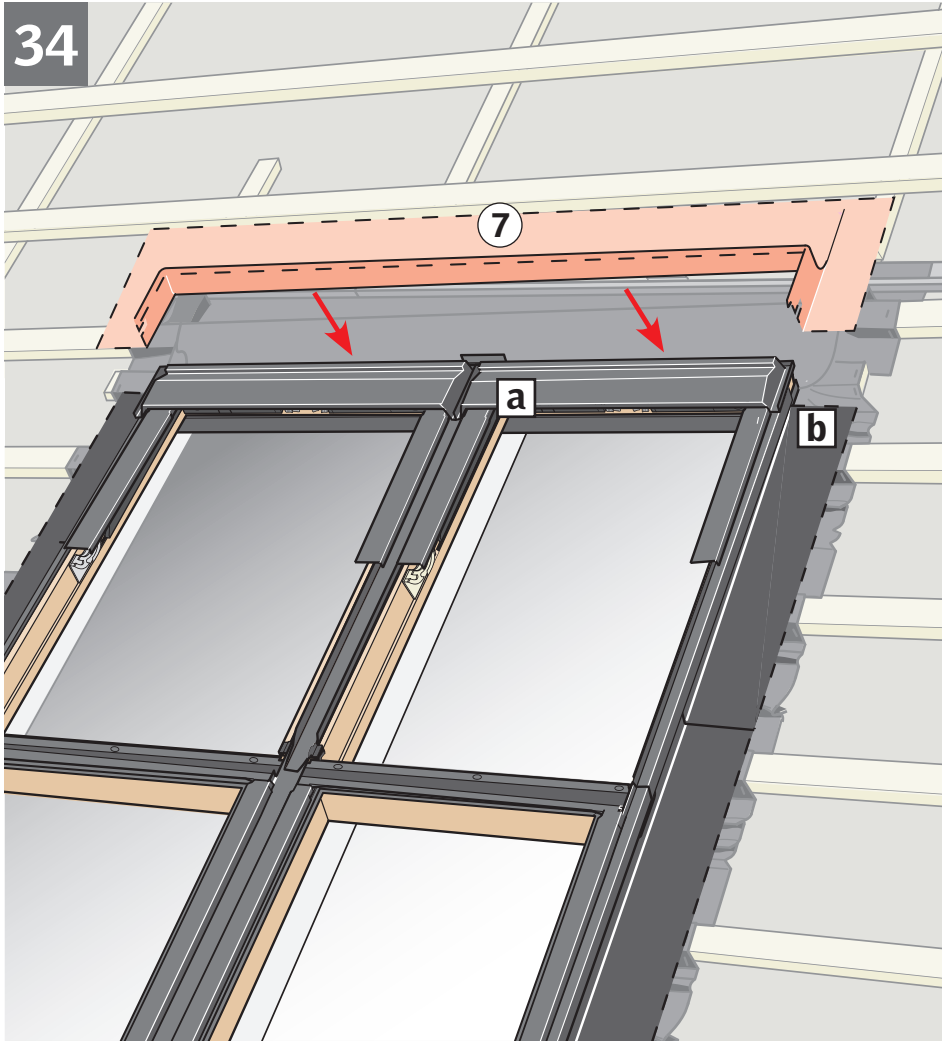

EBL

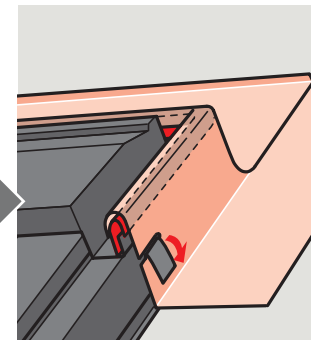
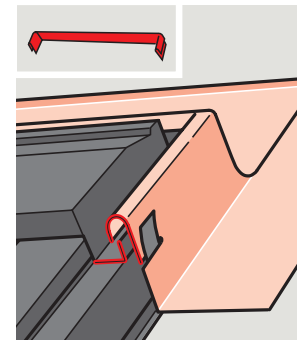
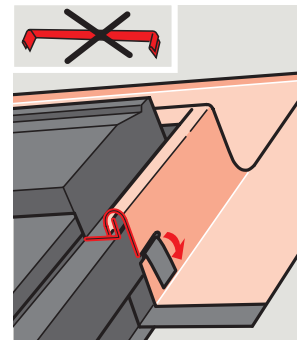
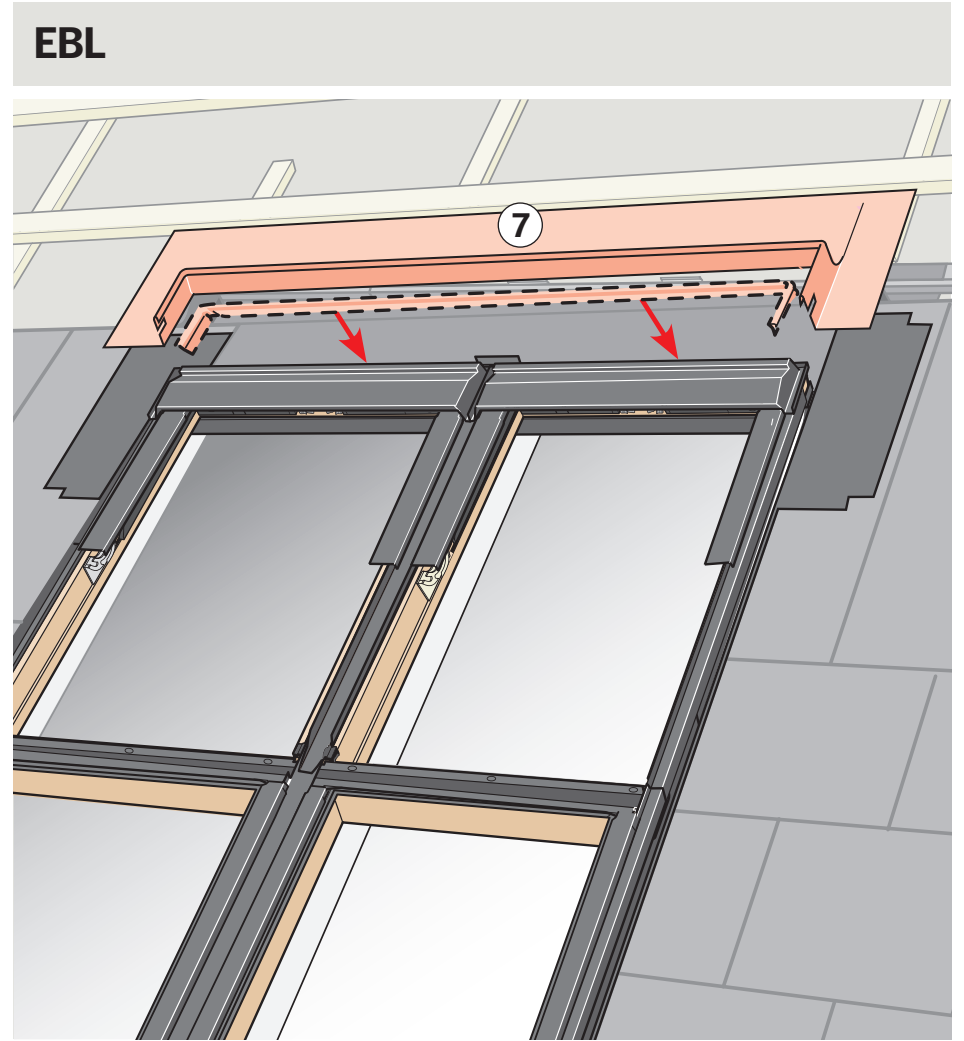

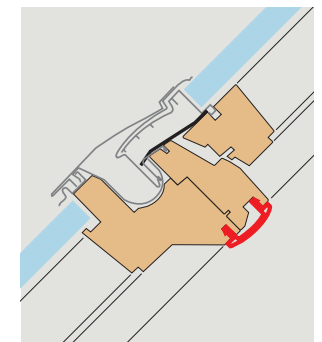
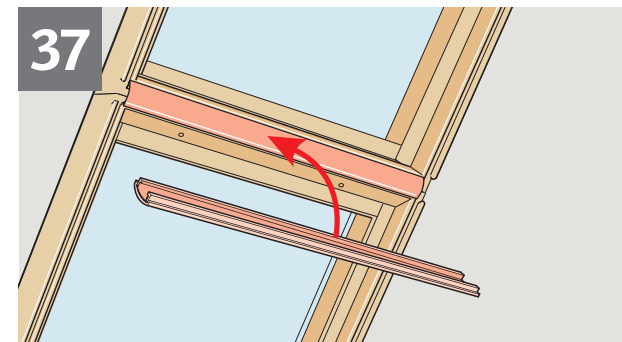
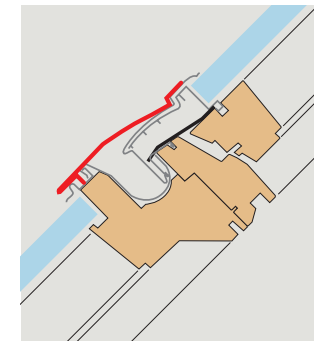
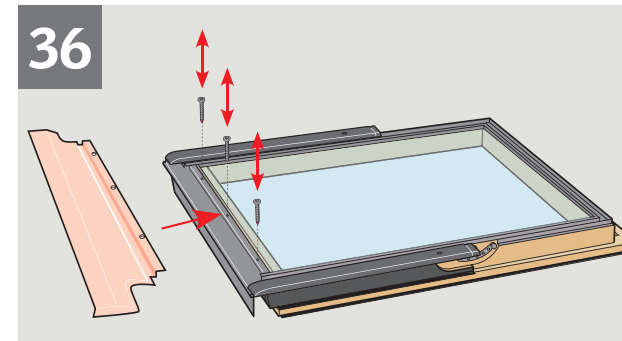
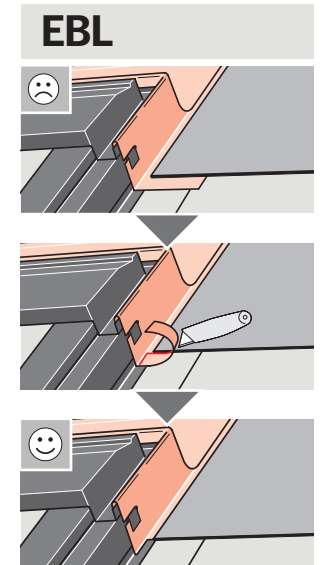
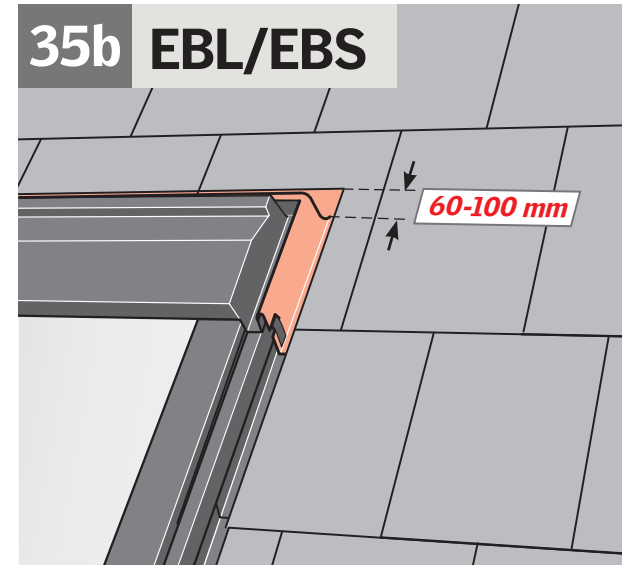
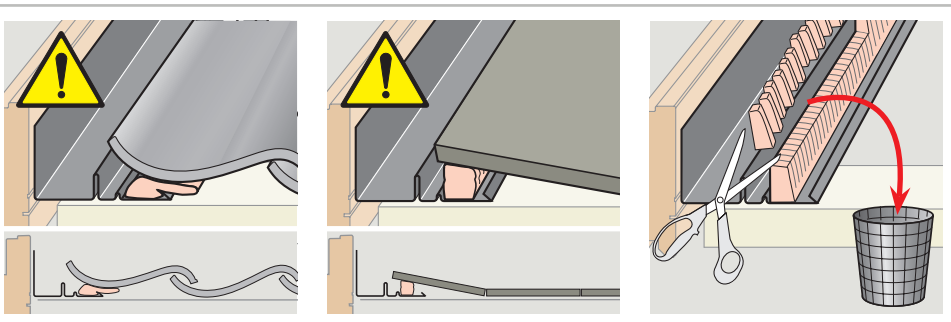
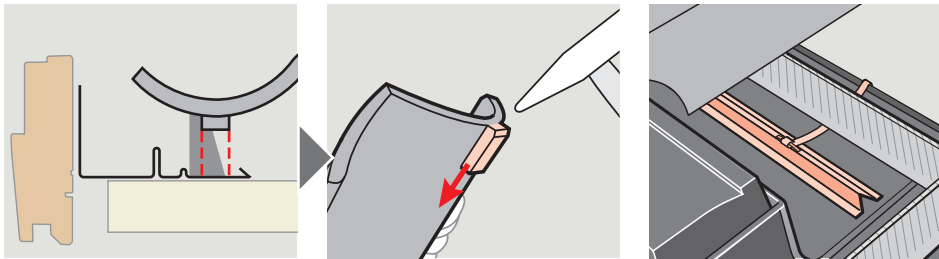
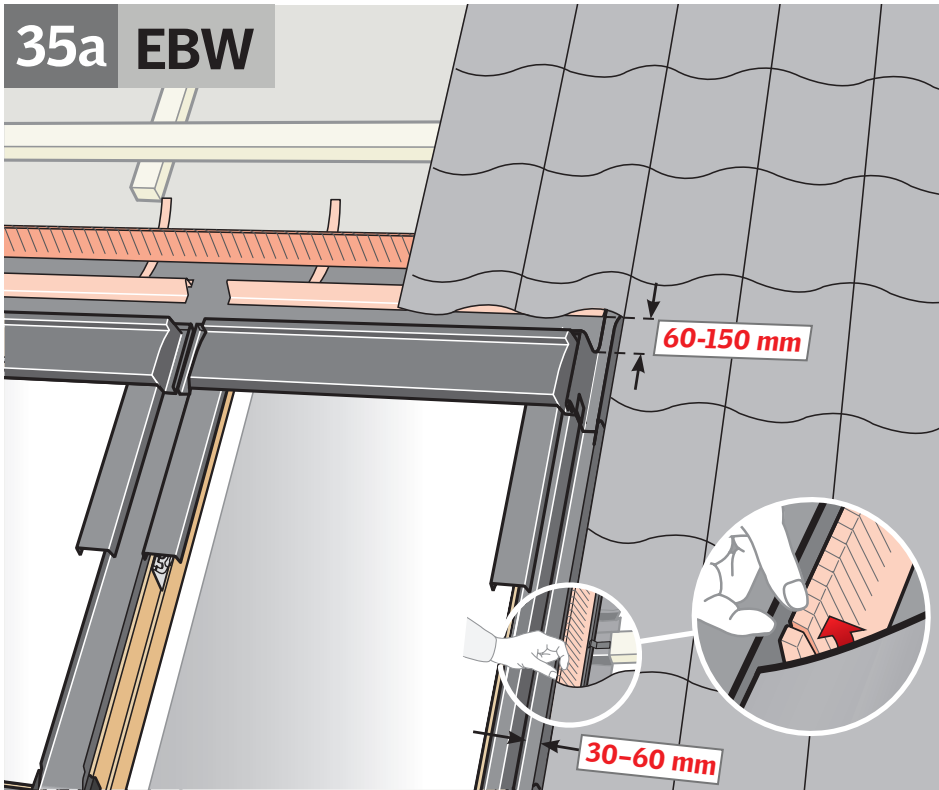

AR: VELUX Argentina S.A. 348 4 639944	IE: VELUX Company Ltd. 01 848 8775
AT: VELUX Österreich GmbH 02245/32 3 50	IT: VELUX Italia s.p.a. 045/6173666
AU: VELUX Australia Pty. Ltd. 1300 859 856	JP: VELUX-Japan Ltd. 0570-00-8145
BA: VELUX Bosna i Hercegovina d.o.o. 033/626 493, 626 494	LT: VELUX Lietuva, UAB (85) 270 91 01
BE: VELUX Belgium (010) 42.09.09	LV: VELUX Latvia SIA 67 27 77 33
BG: ВЕЛУКС България ЕООД 02/955 99 30	NL: VELUX Nederland B.V. 030 - 6 629 629
BY: Унитарное предприятие "ВЕЛЮКС Мансардные Окна" (017) 329 20 89	NO: VELUX Norge AS 22 51 06 00
CA: VELUX Canada Inc. 1 800 88-VELUX (888-3589)	NZ: VELUX New Zealand Ltd. 0800 650 445
CH: VELUX Schweiz AG 062 289 44 45	PL: VELUX Polska Sp. z o.o. (022) 33 77 000 / 33 77 070
CL: VELUX Chile Limitada 2 953 6789	PT: VELUX Portugal, Lda 21 880 00 60
CN: VELUX (CHINA) CO. LTD. 0316-607 27 27	RO: VELUX România S.R.L. 0-8008-83589
CZ: VELUX Česká republika, s.r.o. 531 015 511	RS: VELUX Srbija d.o.o. 011 20 57 500
DE: VELUX Deutschland GmbH 040 / 54 70 70	RU: ЗАО ВЕЛЮКС (495) 640 87 20
DK: VELUX Danmark A/S 45 16 45 16	SE: VELUX Svenska AB 042/20 83 80
EE: VELUX Eesti OÜ 621 7790	SI: VELUX Slovenija d.o.o. 01 724 68 68
ES: VELUX Spain, S.A. 91 509 71 00	SK: VELUX Slovensko, s.r.o. (02) 33 000 555
FI: VELUX Suomi Oy 0207 290 800	TR: VELUX Çatı Pencereleri Ticaret Limited Şirketi 0 216 302 54 10
FR: VELUX France 0821 02 15 15 0,119€ TTC/min	UA: ТОВ "ВЕЛЮКС Україна" (044) 2916070
GB: VELUX Company Ltd. 01592 778 225	US: VELUX America LLC 1-800-88-VELUX
HR: VELUX Hrvatska d.o.o. 01/5555 444	
HU: VELUX Magyarország Kft. (06/1) 436-0601	