

VELUX®

FMC

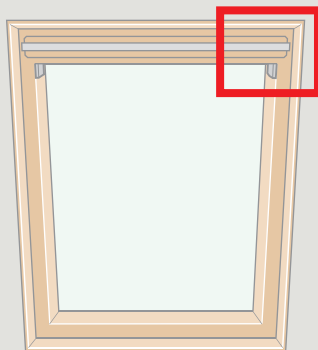

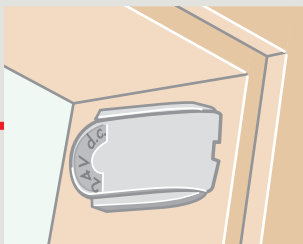



**PAGES
4-15**

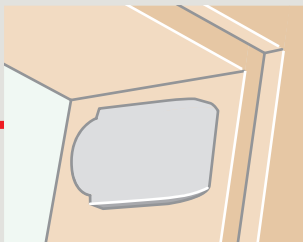

**PAGES
16-29**

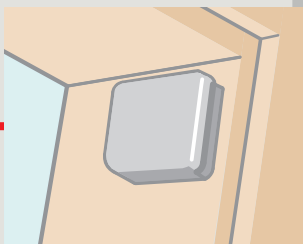

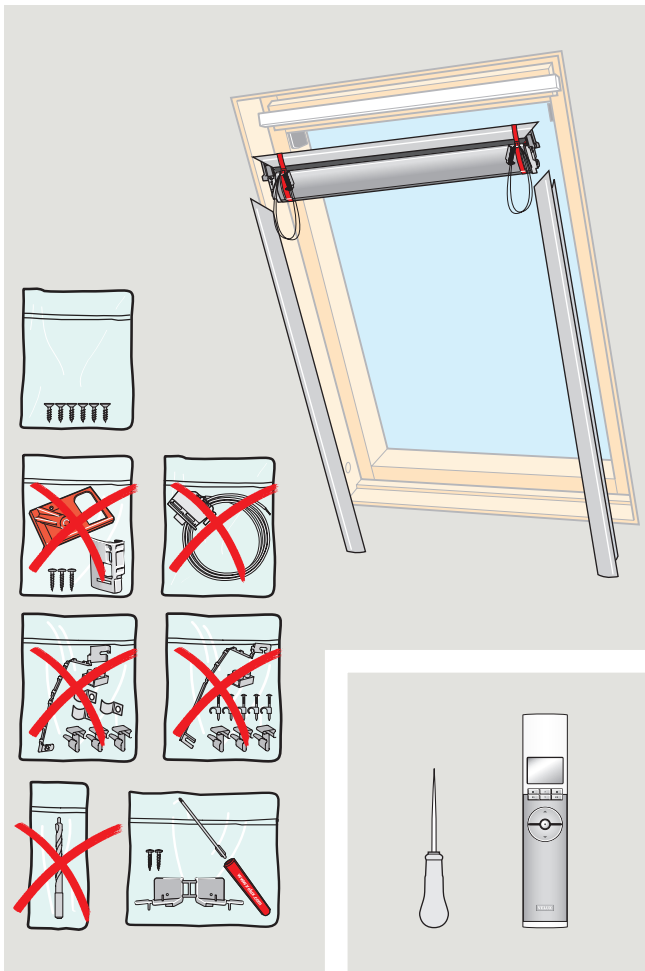

1

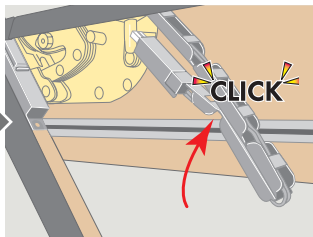
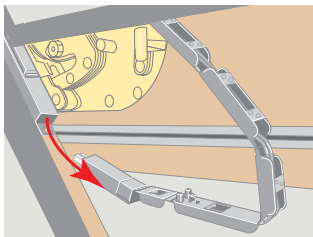
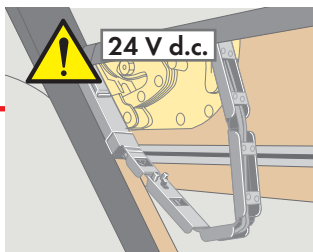
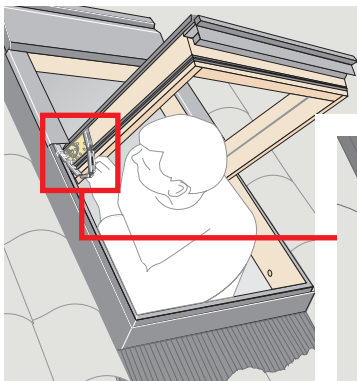
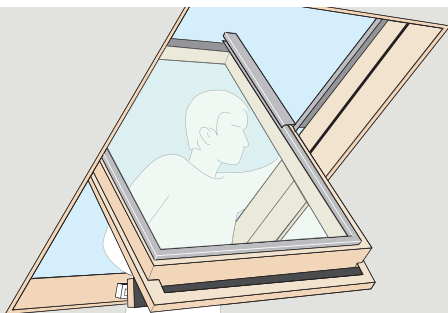

2

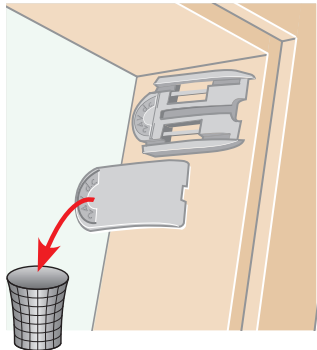
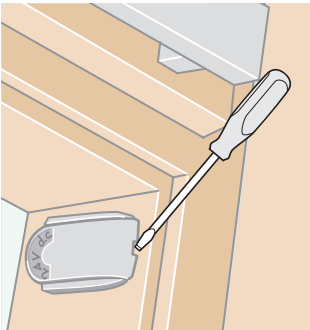
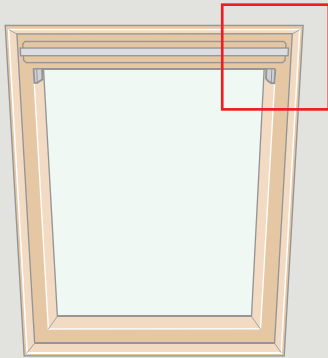

3

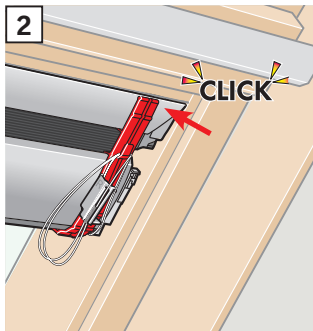
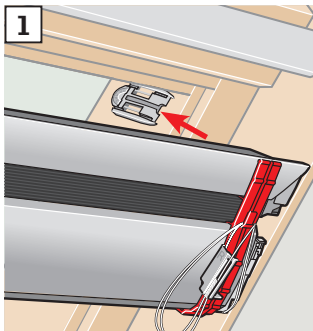
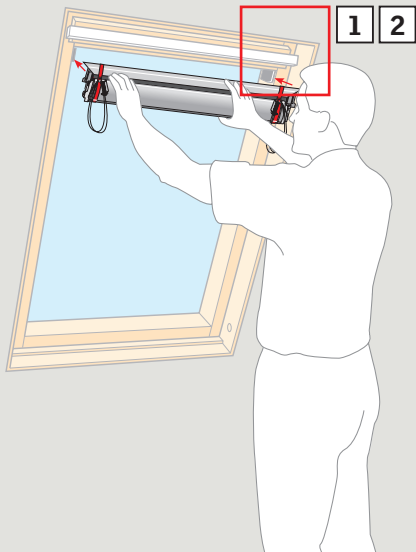

4

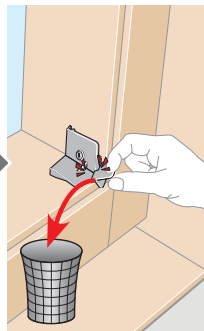
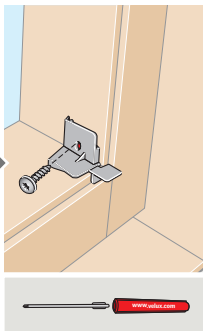
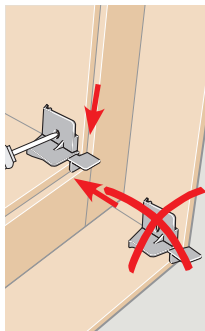
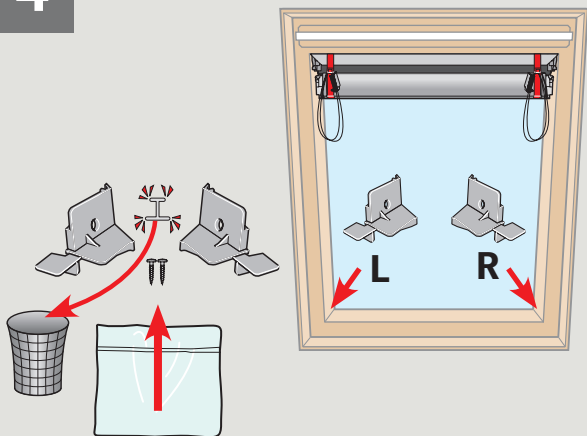

5

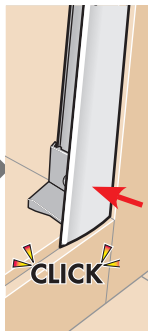
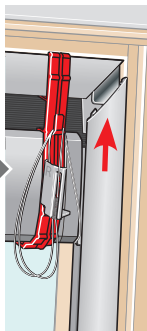
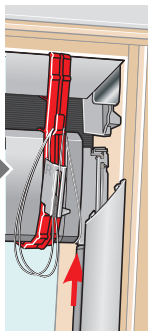
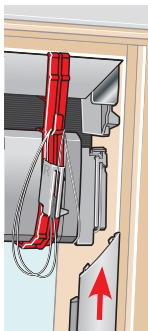
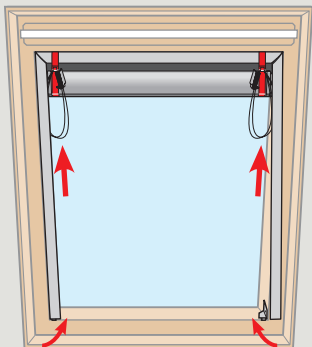
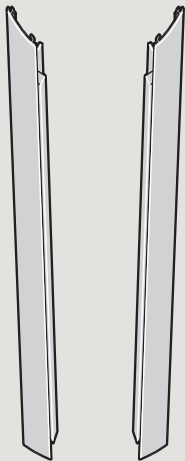

6

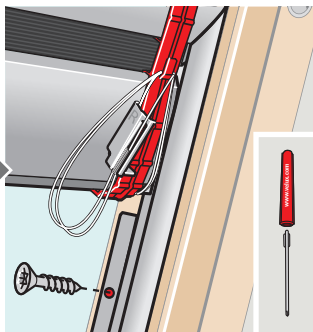
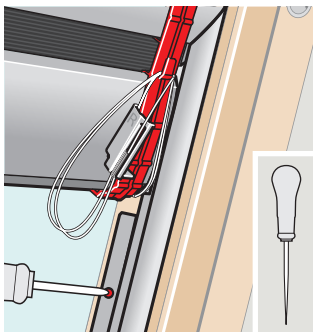
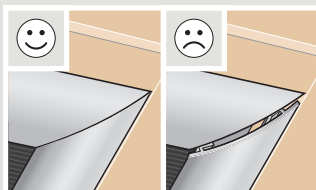
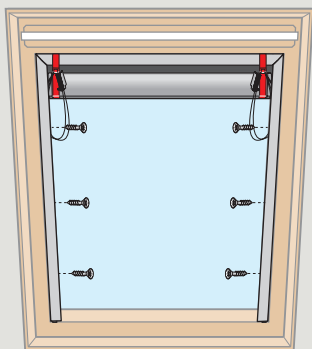
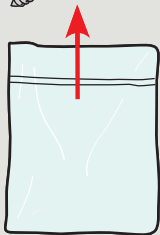

7

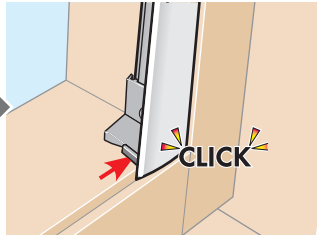
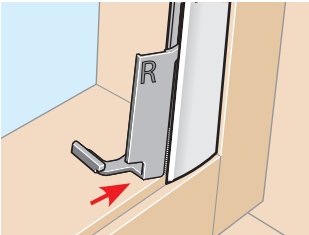
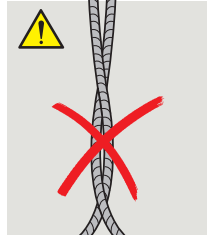
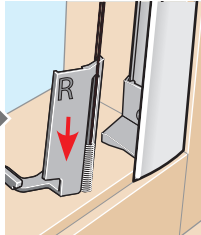
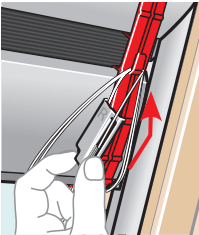
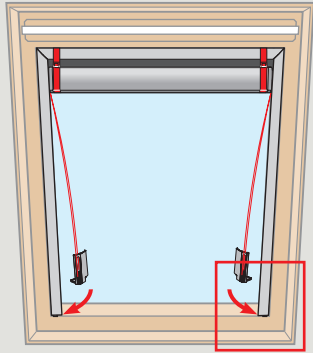

8

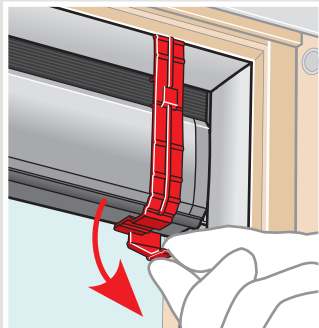
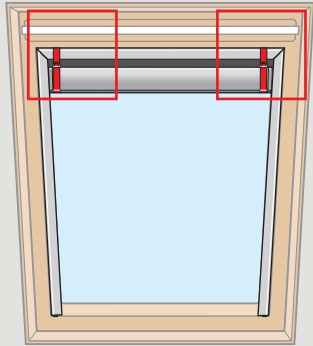

9

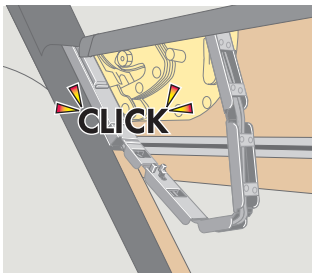
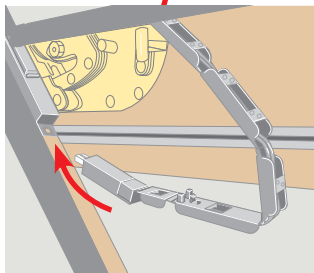
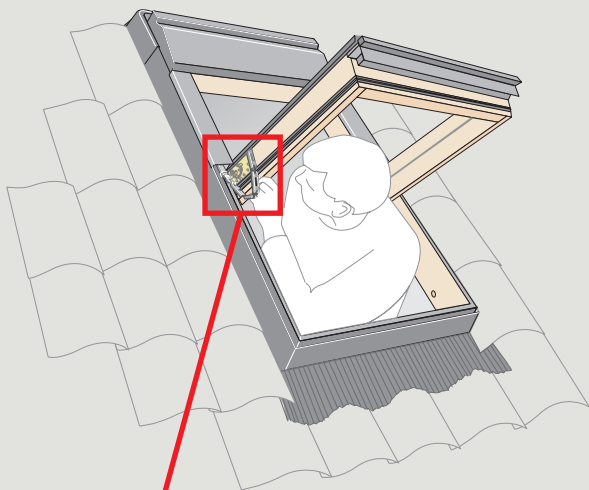

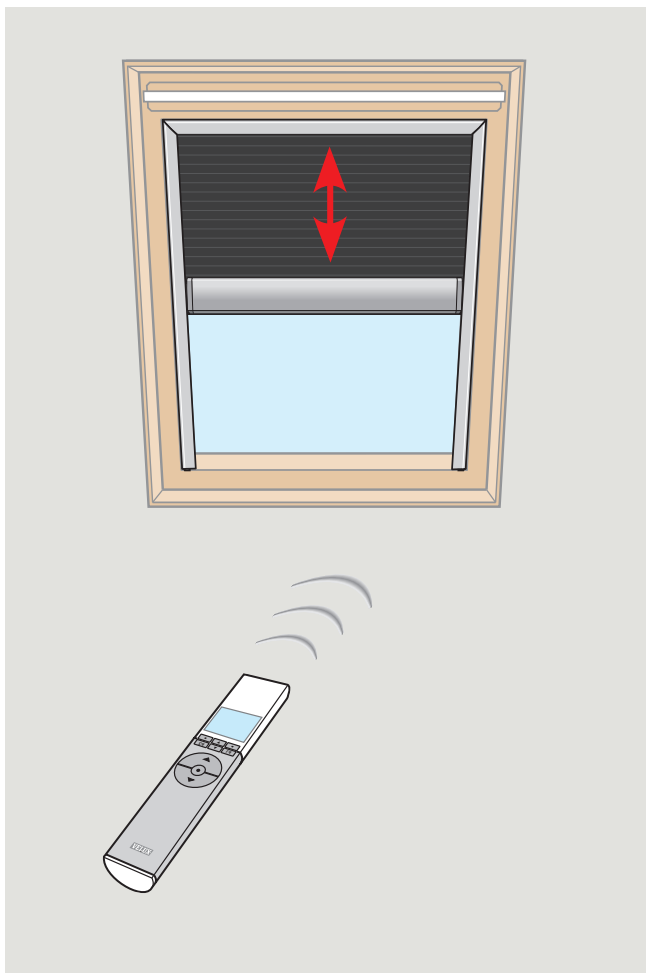

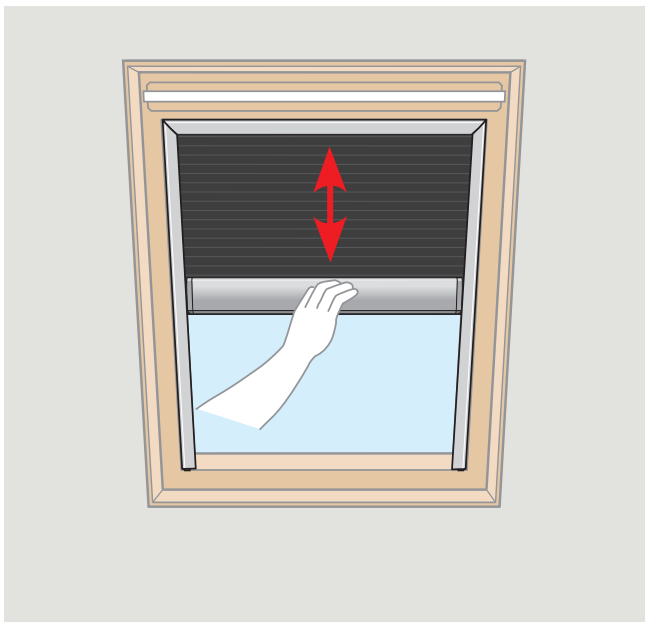

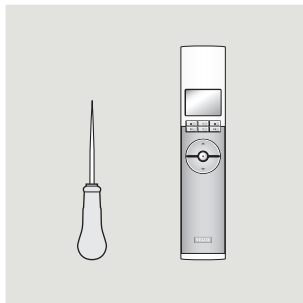
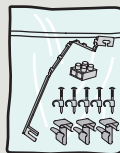
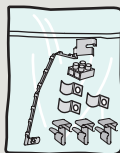
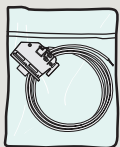
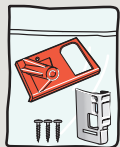
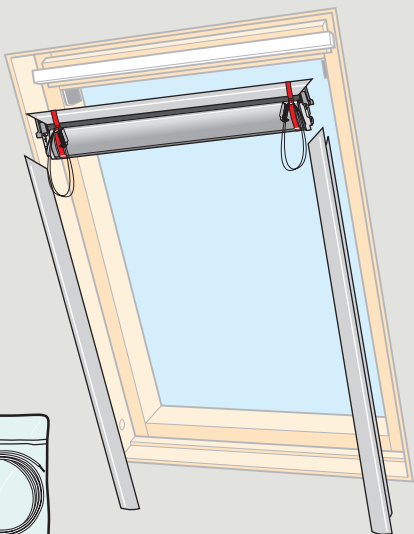

1

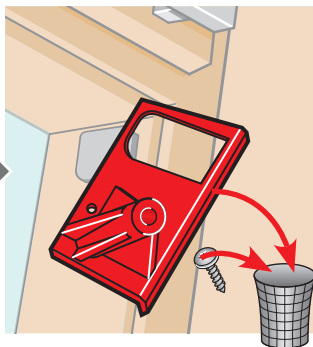
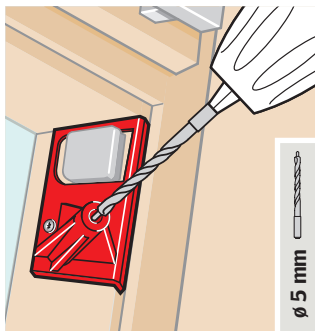
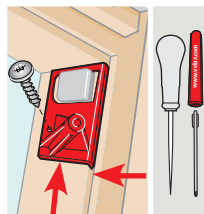
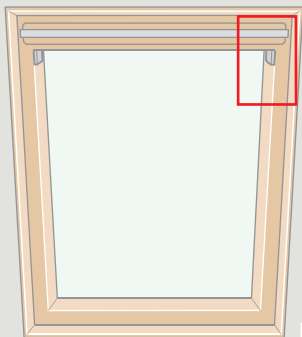

2

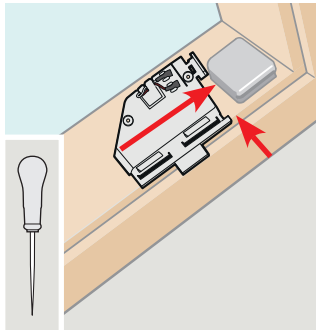
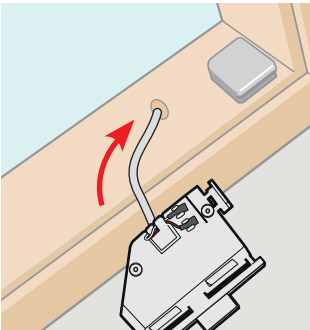
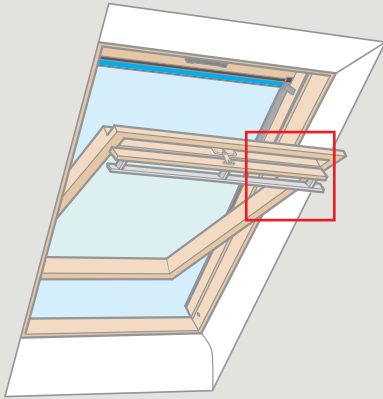

3

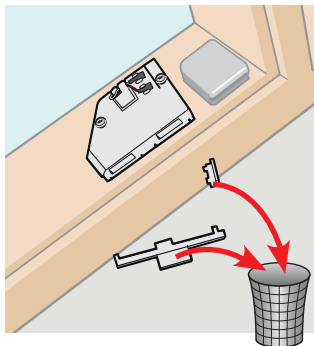
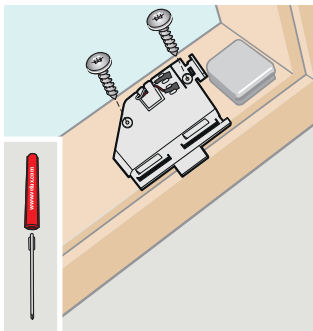
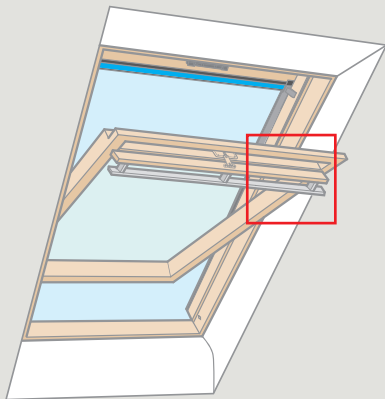

4

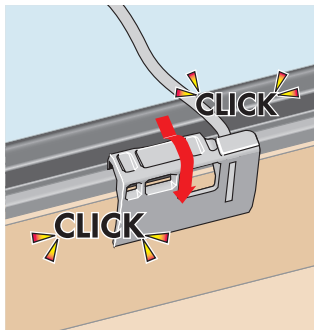
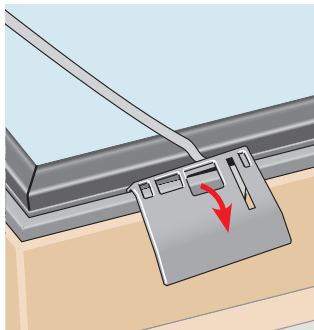
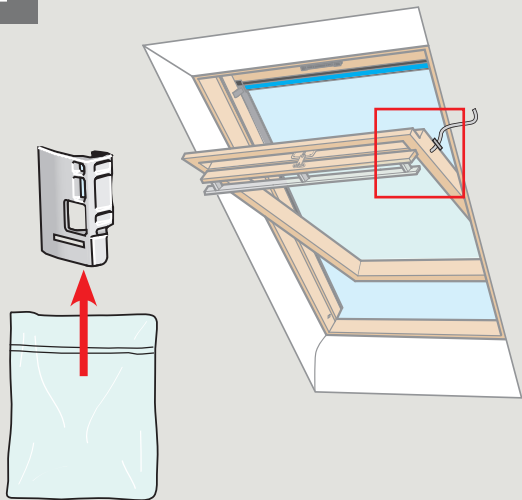

5

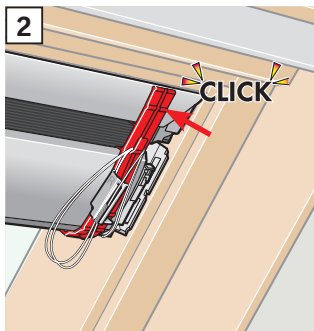
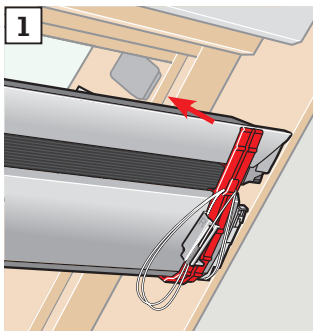
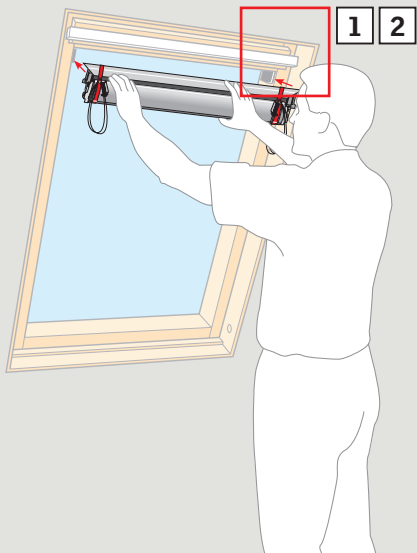

6

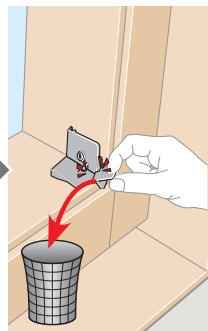
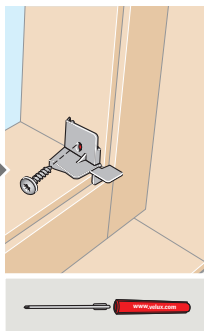
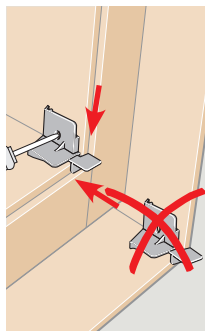
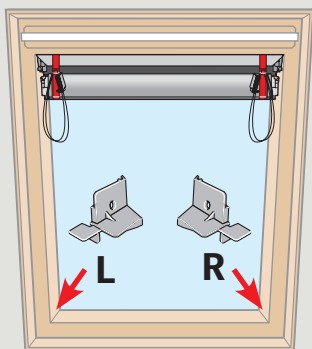
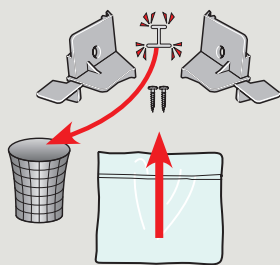

7

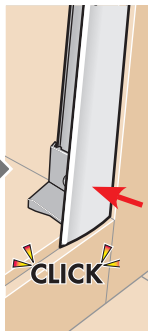
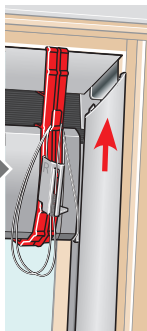
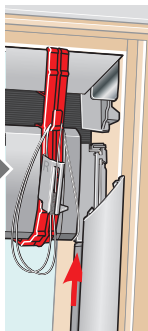
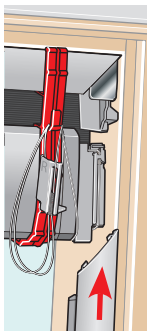
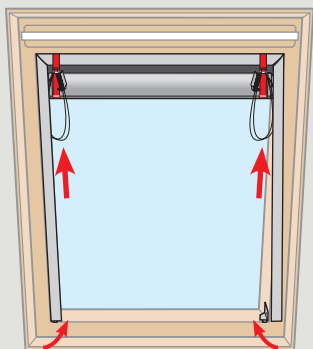
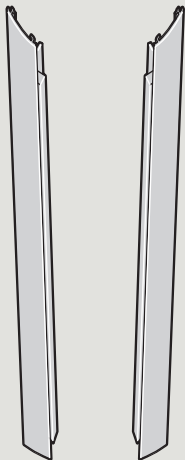

8

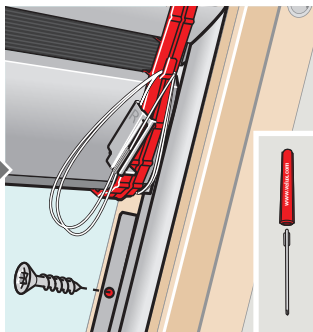
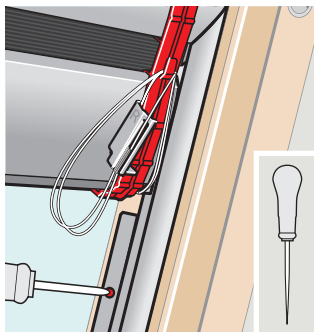
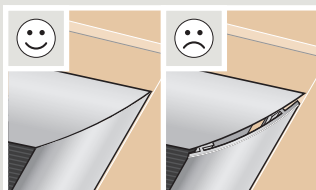
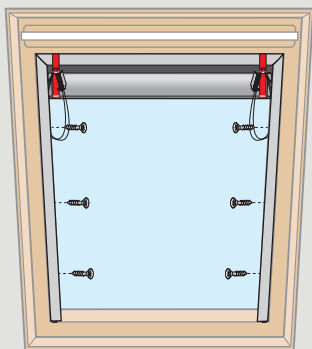
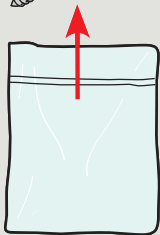

9

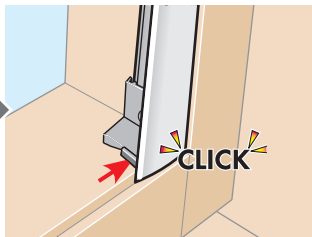
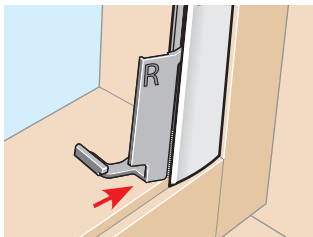
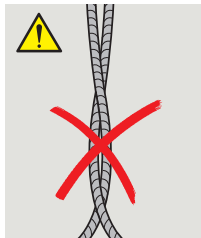
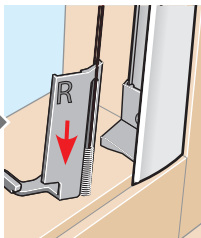
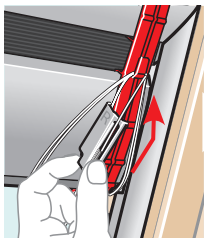
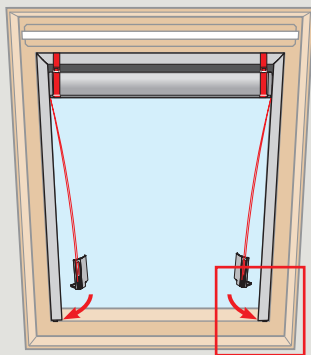

10

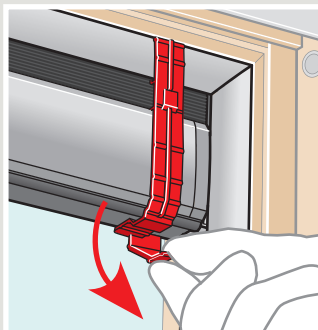
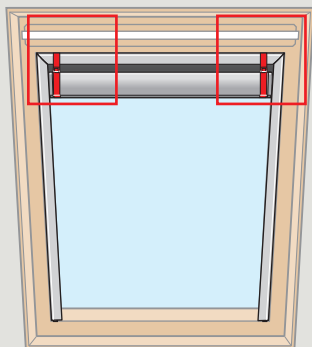

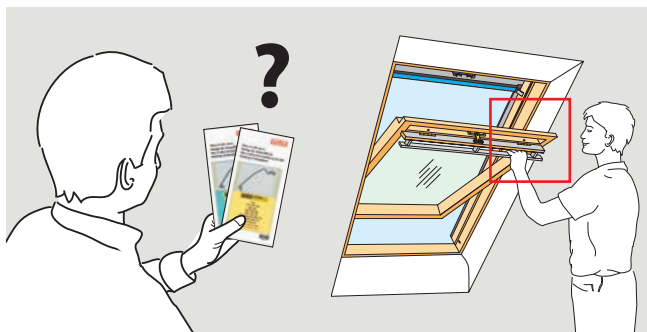

B04
C01•C02•C04•C06
F04•F06•F08
M04•M06•M08•M10•M12
P25•P04•P06•P08•P10
S01•S06•S08•S10
U04•U08•U10
X99

064
101•102•104
204•206
325•304•306
308•310•312
425•404•406•408•410
601•606•608•610
804•808•810
1•2•3•4•5•6•7•8•9
10•11•13•14•31•999

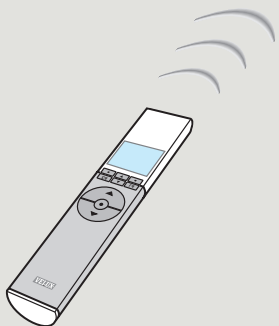
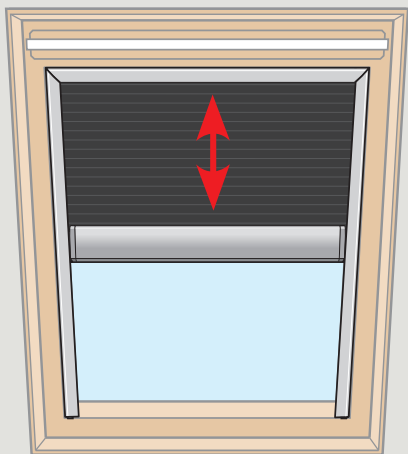

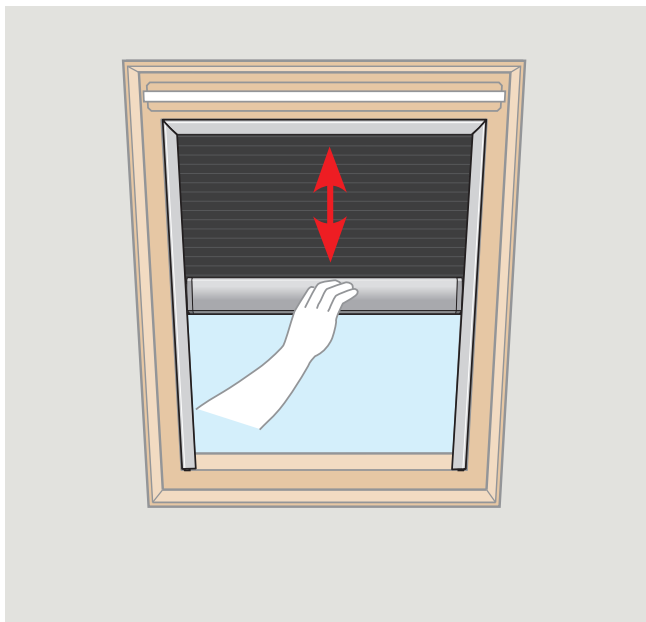

VELUX®

AR:	VELUX Argentina S.A. 348 4 639944	HU:	VELUX Magyarország Kft. (06/1) 436-0601
AT:	VELUX Österreich GmbH 02245/32 3 50	IE:	VELUX Company Ltd. 01 848 8775
AU:	VELUX Australia Pty. Ltd. 1300 859 856	IT:	VELUX Italia s.p.a. 045/6173666
BA:	VELUX Bosna i Hercegovina d.o.o. 033/626 493, 626 494	JP:	VELUX-Japan Ltd. 0570-00-8145
BE:	VELUX Belgium (010) 42.09.09	LT:	VELUX Lietuva, UAB (85) 270 91 01
BG:	VELUX Bulgaria EOOD 02/955 99 30	LV:	VELUX Latvia SIA 67 27 77 33
BY:	FE VELUX Roof Windows (017) 217 7385	NL:	VELUX Nederland B.V. 030 - 6 629 629
CA:	VELUX Canada Inc. 1 800 88-VELUX (888-3589)	NO:	VELUX Norge AS 22 51 06 00
CH:	VELUX Schweiz AG 0848 945 549	NZ:	VELUX New Zealand Ltd. 0800 650 445
CL:	VELUX Chile Limitada 2 953 6789	PL:	VELUX Polska Sp. z o.o. (022) 33 77 000 / 33 77 070
CN:	VELUX (CHINA) CO. LTD. 0316-607 27 27	PT:	VELUX Portugal, Lda 21 880 00 60
CZ:	VELUX Česká republika, s.r.o. 531 015 511	RO:	VELUX România S.R.L. 0-8008-83589
DE:	VELUX Deutschland GmbH 01806 / 33 33 99 Festnetz: 0,20 €/Anruf Mobilfunk: max. 0,60 €/Anruf	RS:	VELUX Srbija d.o.o. 011 20 57 500
DK:	VELUX Danmark A/S 45 16 45 16	RU:	ZAO VELUX 8 800 200 7520
EE:	VELUX Eesti OÜ 621 7790	SE:	VELUX Svenska AB 042/20 83 80
ES:	VELUX Spain, S.A. 91 509 71 00	SI:	VELUX Slovenija d.o.o. 01 724 68 68
FI:	VELUX Suomi Oy 0207 290 800	SK:	VELUX Slovensko, s.r.o. (02) 33 000 555
FR:	VELUX France 0821 02 15 15 0,119€ TTC/min	TR:	VELUX Çatı Pencereleeri Ticaret Limited Şirketi 0 216 302 54 10
GB:	VELUX Company Ltd. 01592 778 225	UA:	VELUX Ukraina TOV (044) 2916070
HR:	VELUX Hrvatska d.o.o. 01/5555 444	US:	VELUX America Inc. 1-800-88-VELUX

www.velux.com