

EFW/EFL/EFS +EBY W10

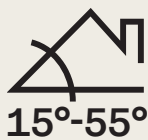

VELUX®



15°-55°



VAS 453327-2024-10

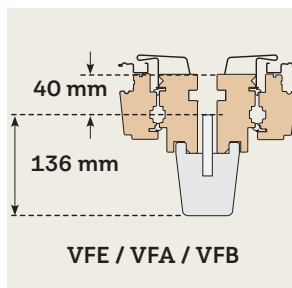
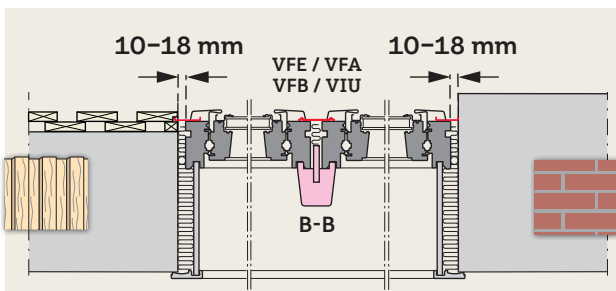
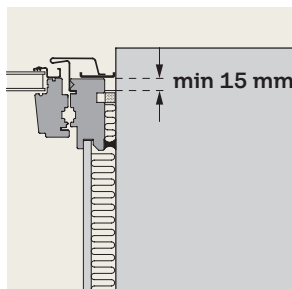
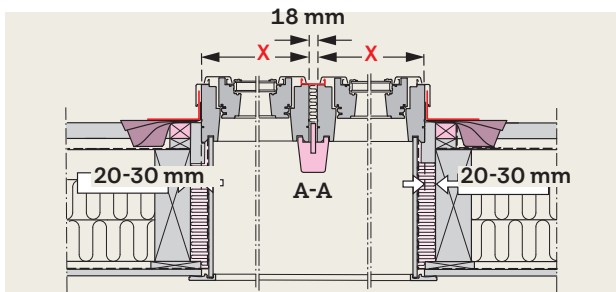
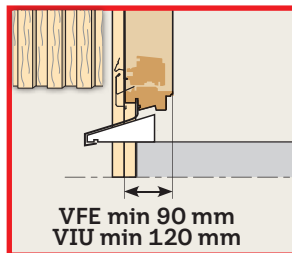
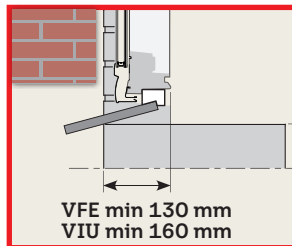
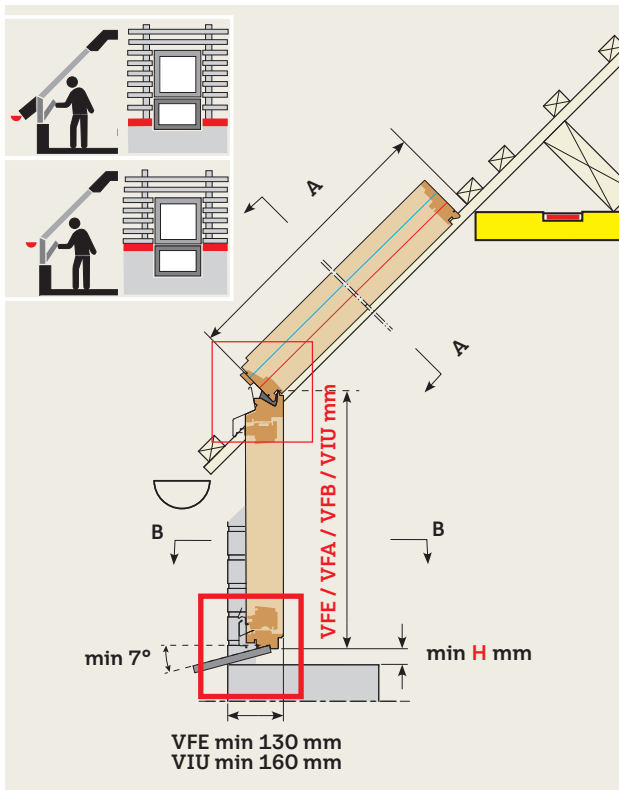

VIU

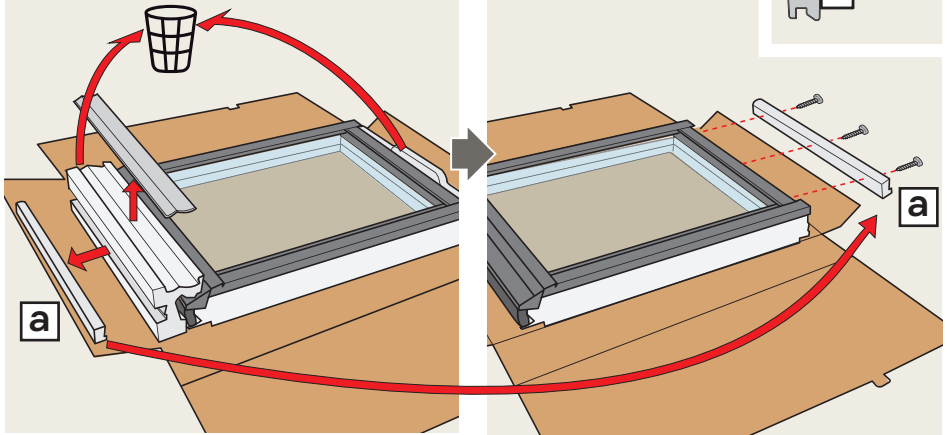

VFE/VFA/VFB

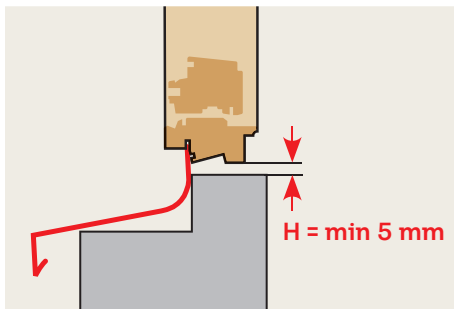
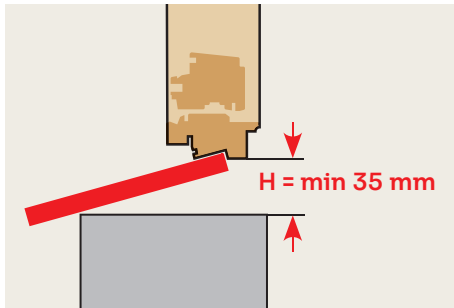

VIU

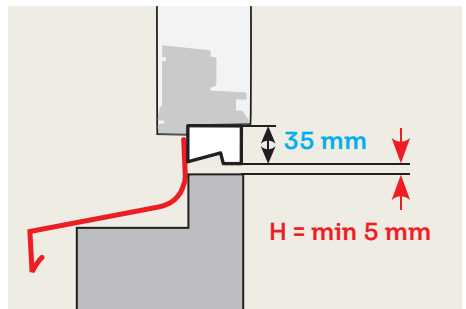
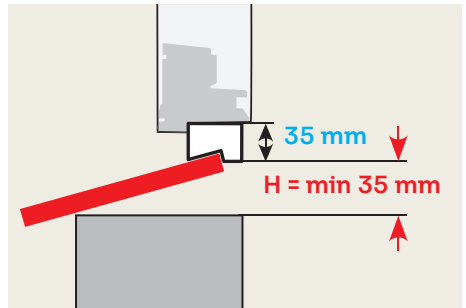

1

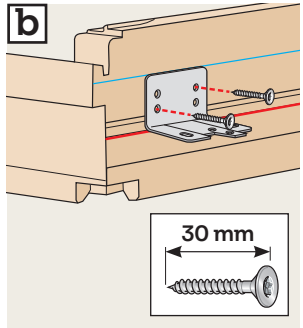
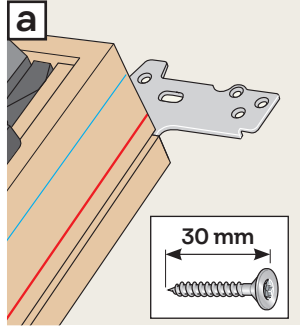
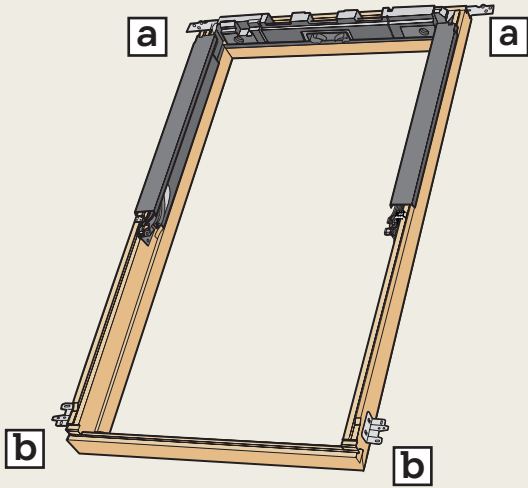

1a VFE/VFA/VFB

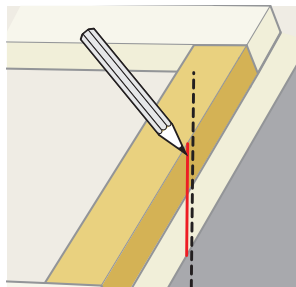
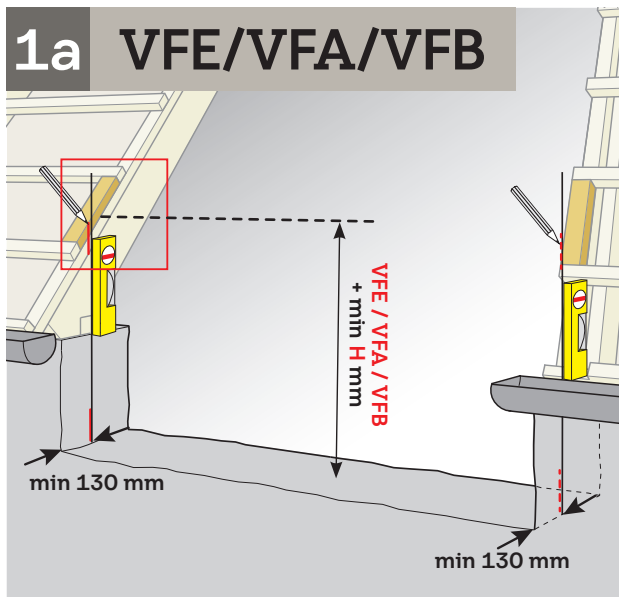

1b VIU

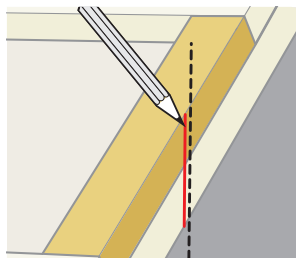
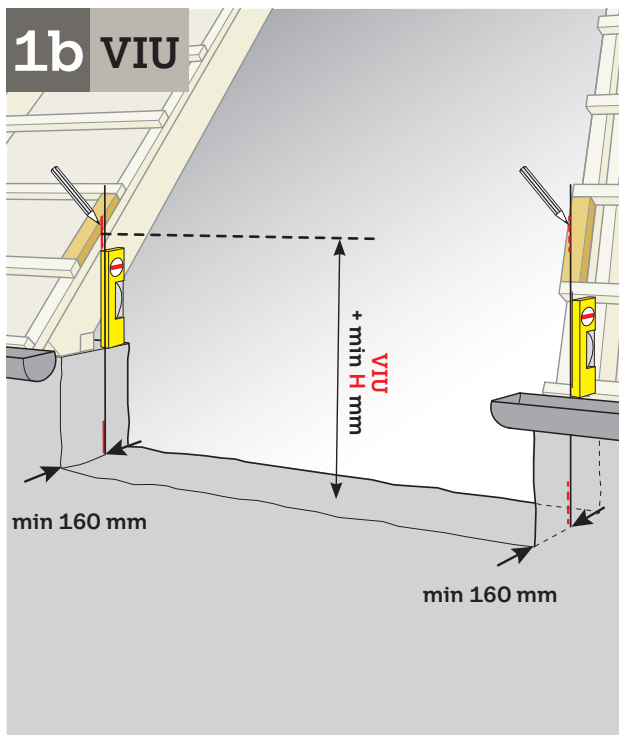

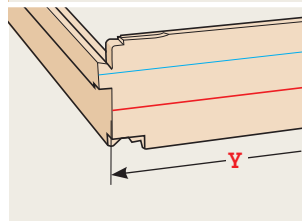
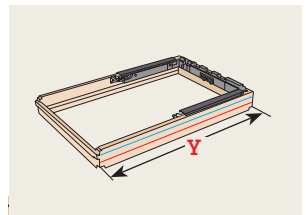
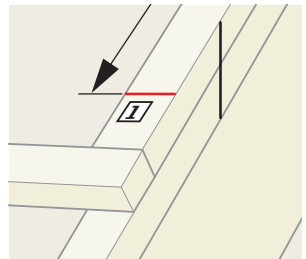
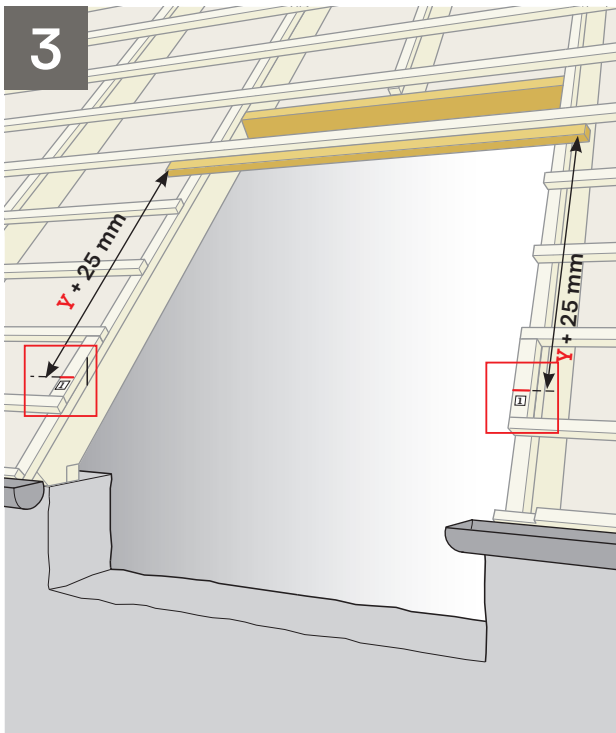
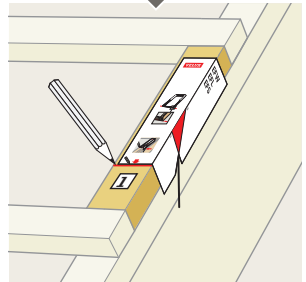
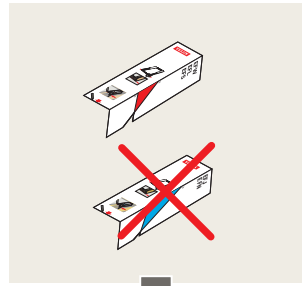
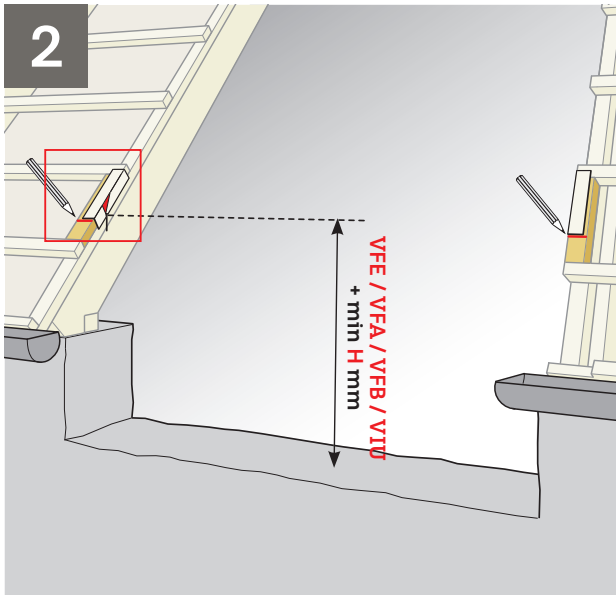

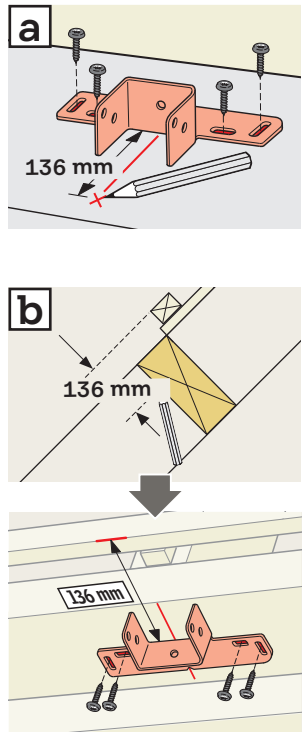
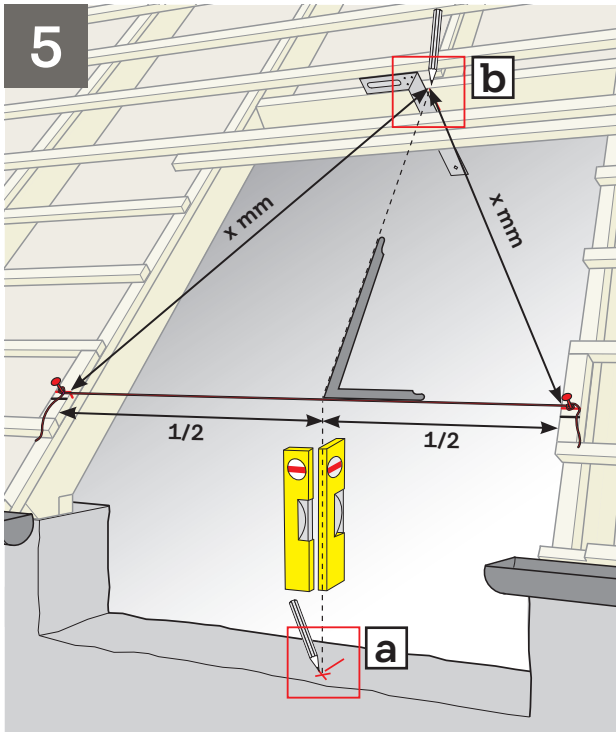
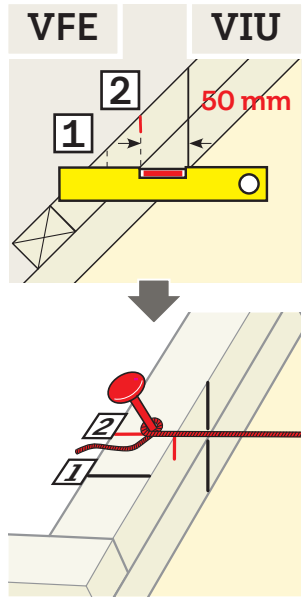
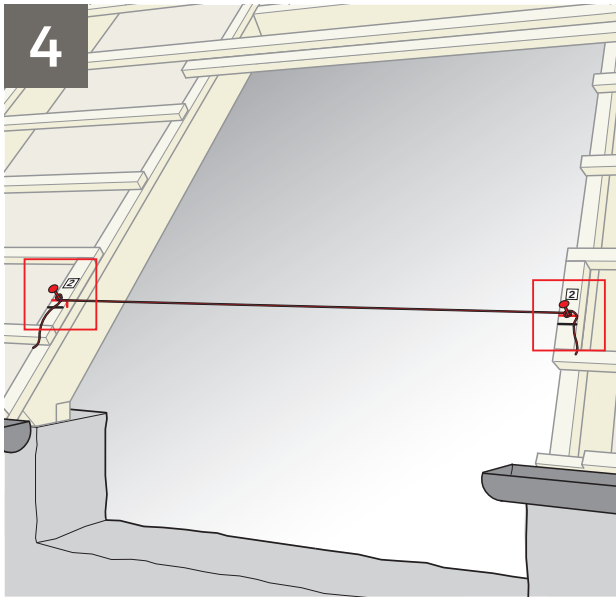

6

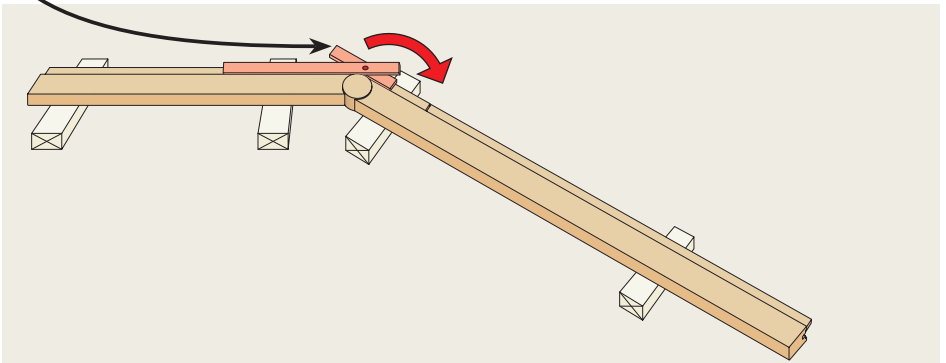
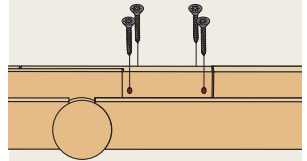
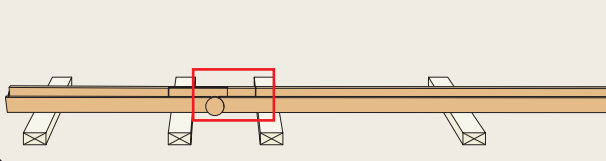
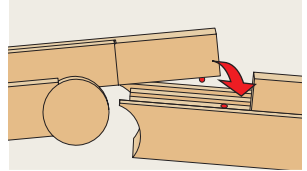
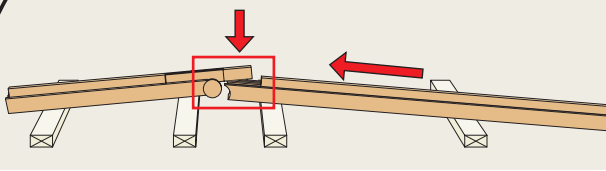
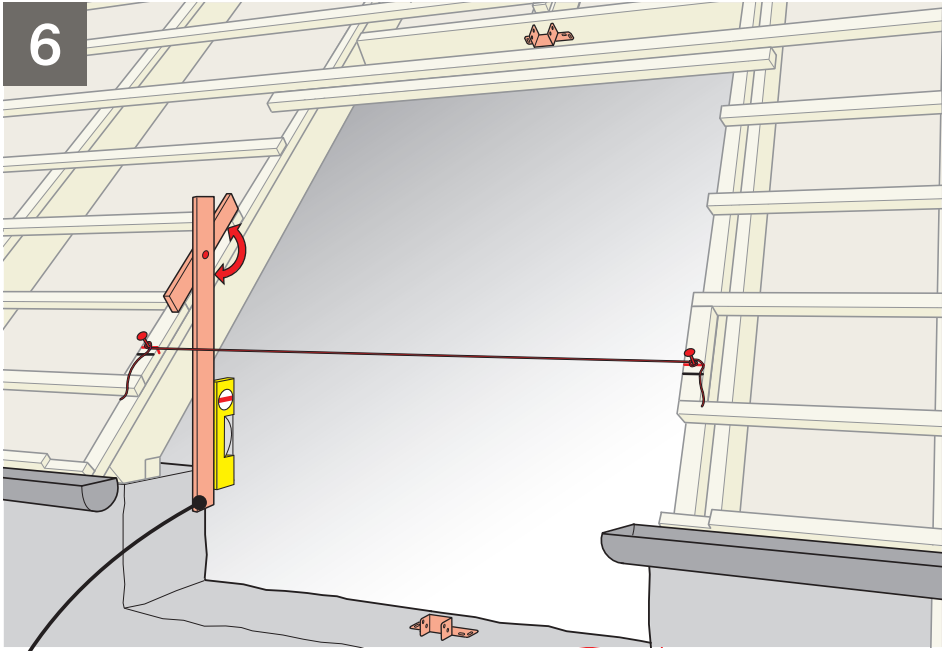

7

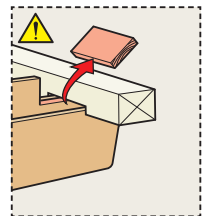
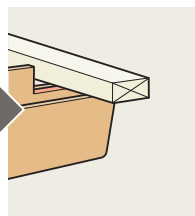
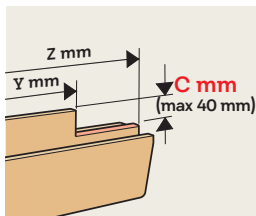
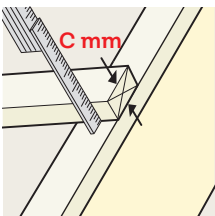
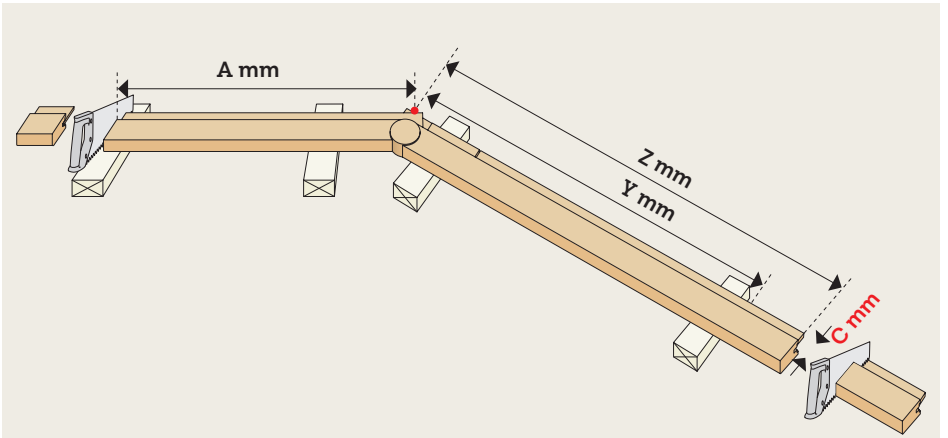
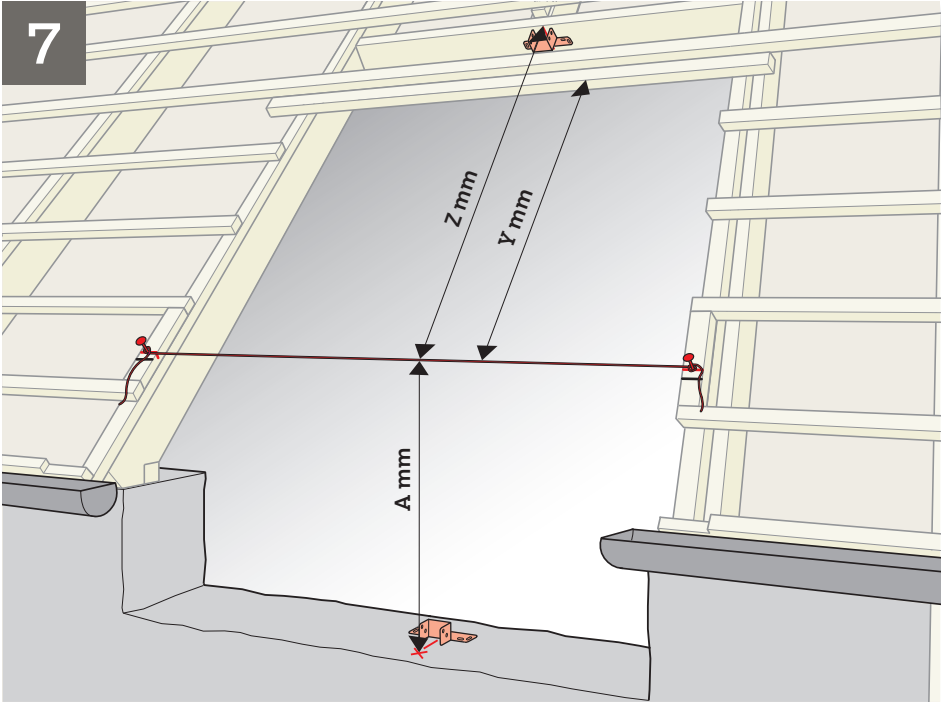

8

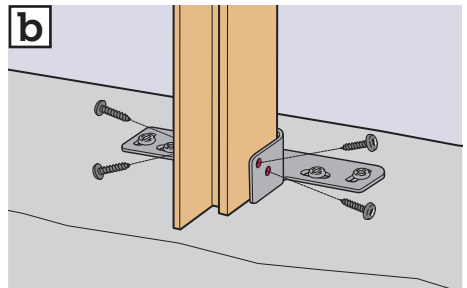
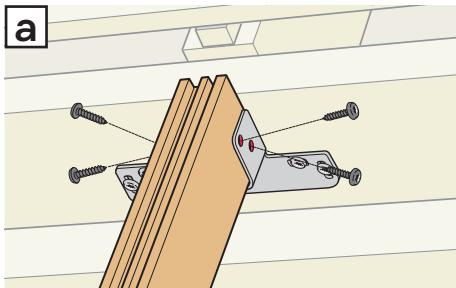
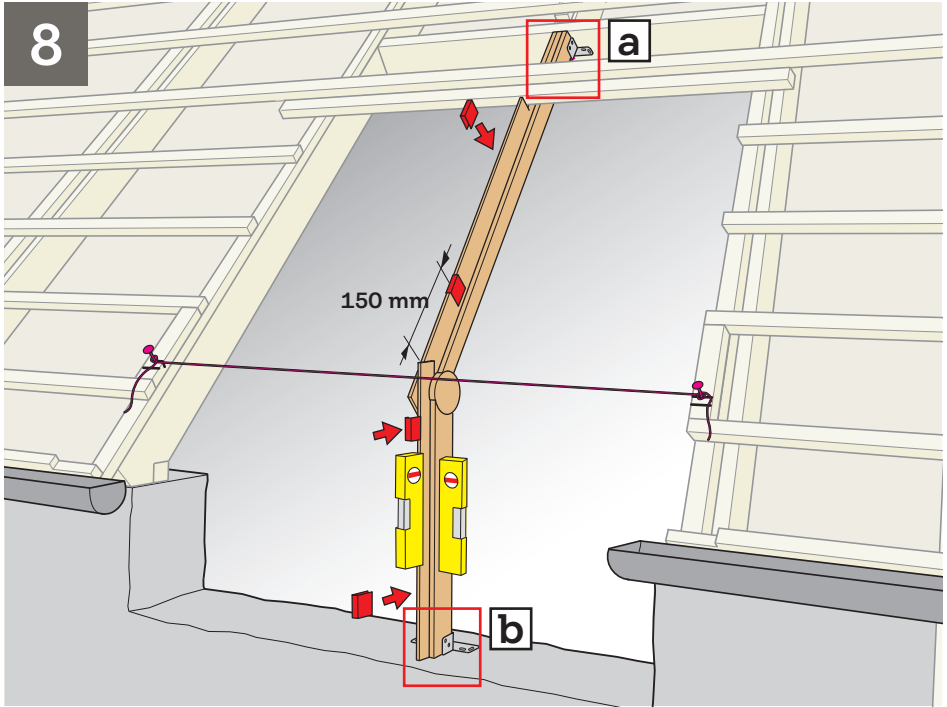

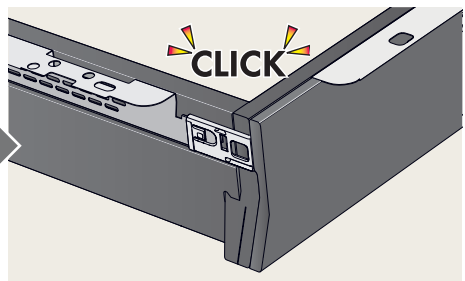
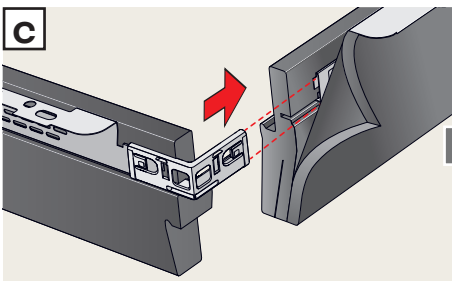
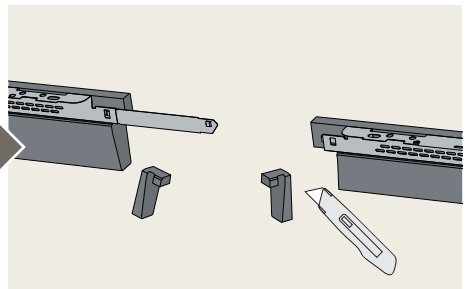
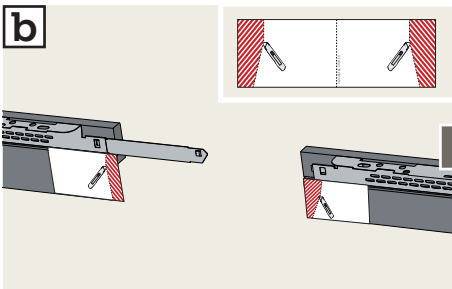
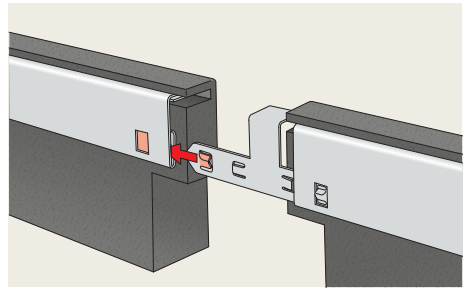
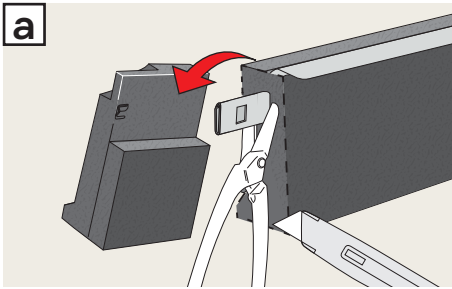
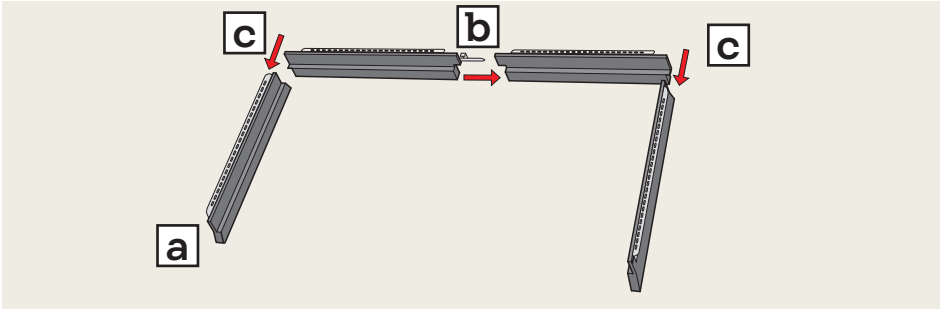

10

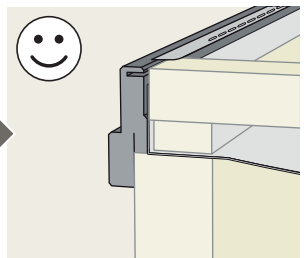
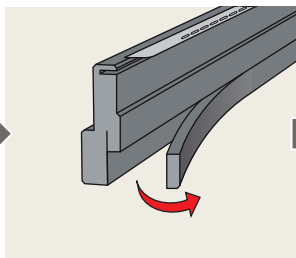
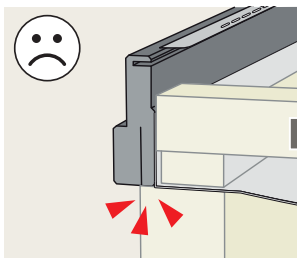
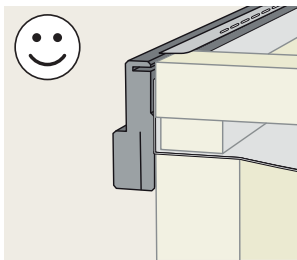
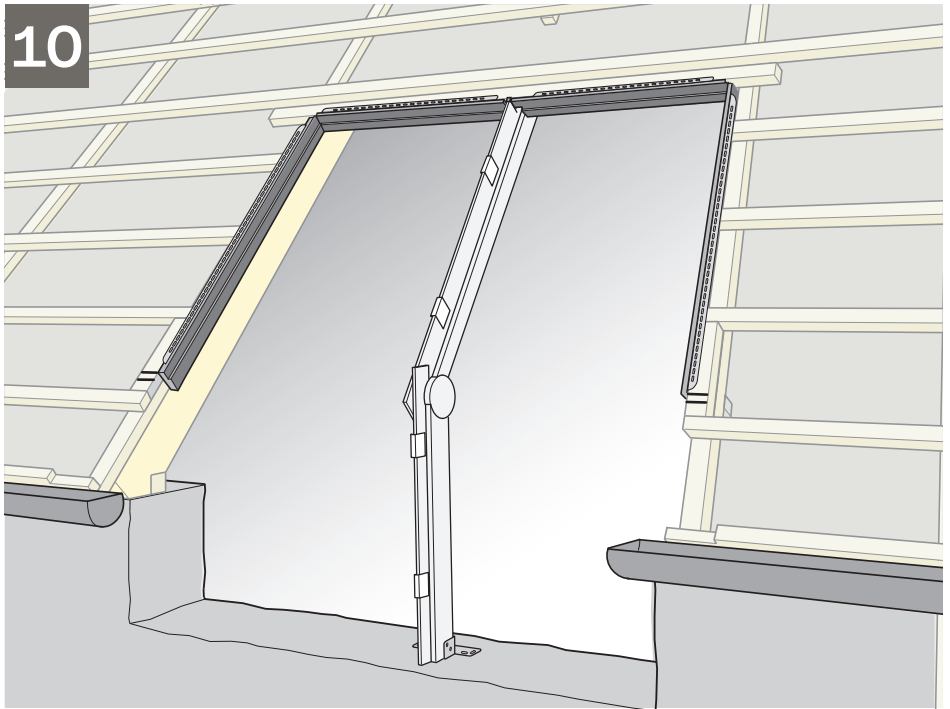

11

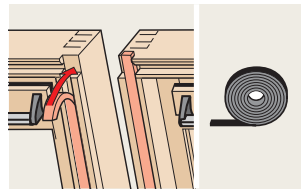
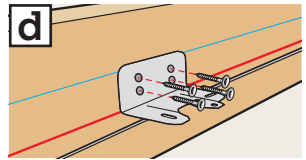
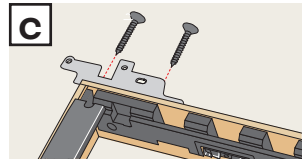
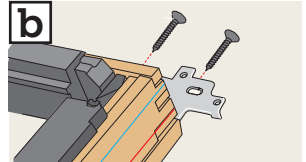
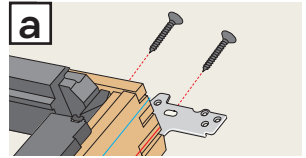
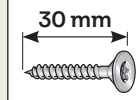
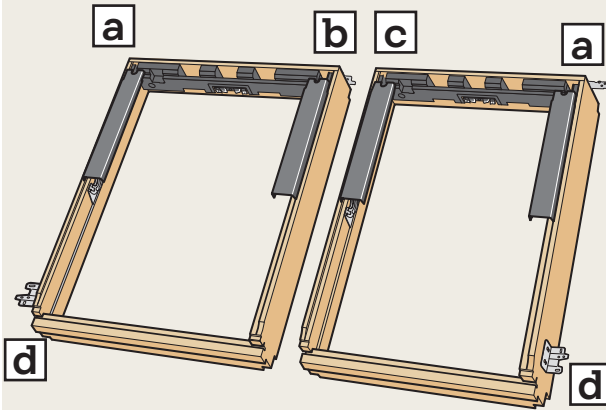

12

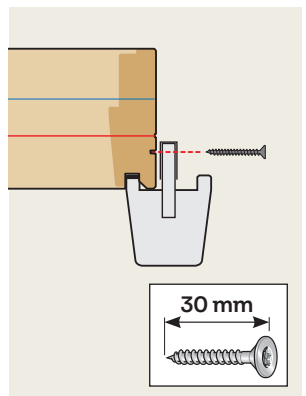
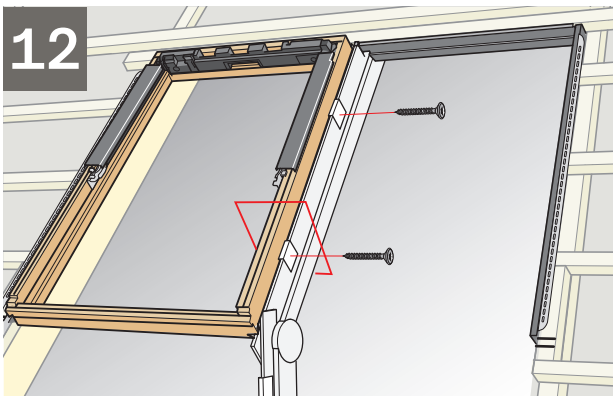

13

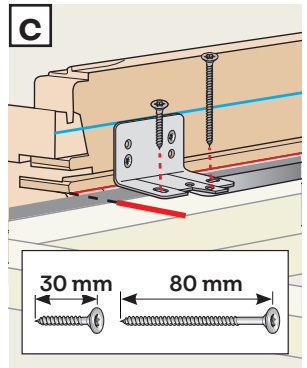
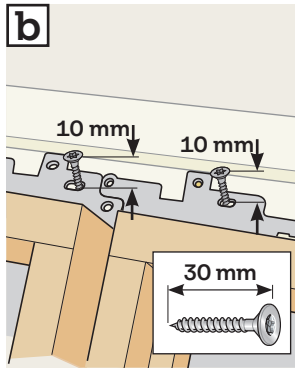
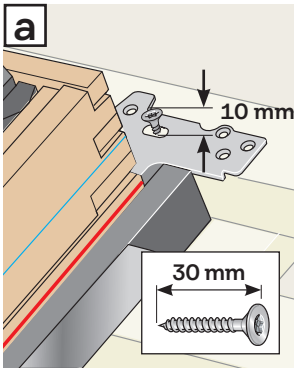
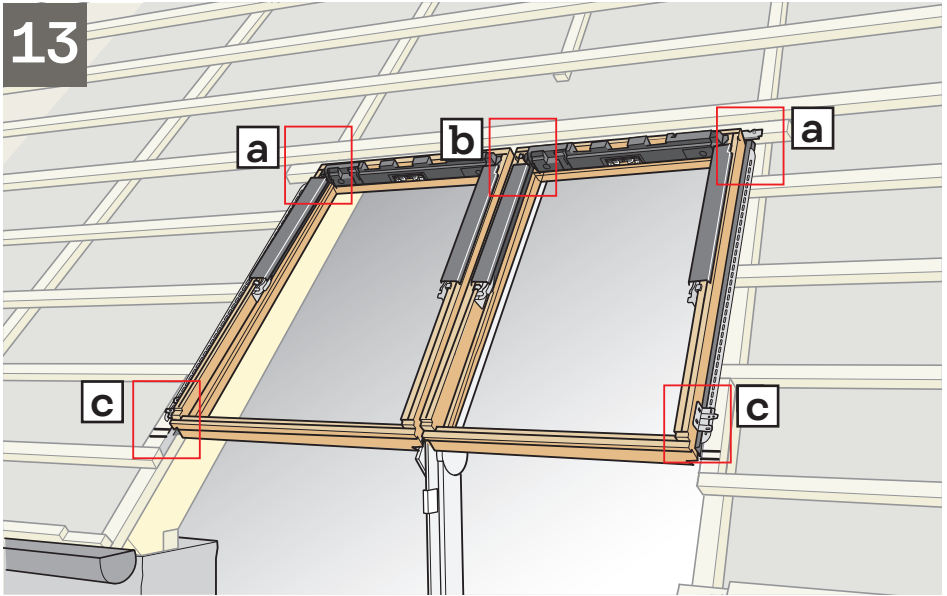

14

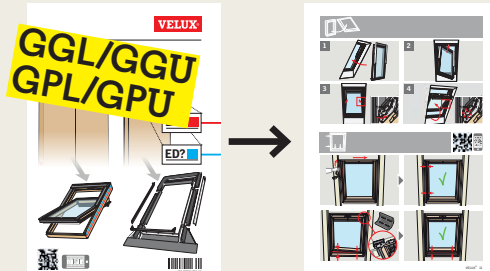

15

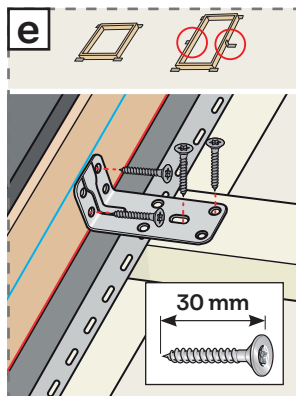
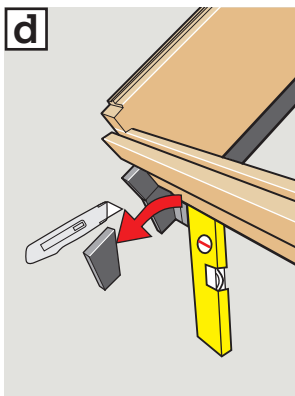
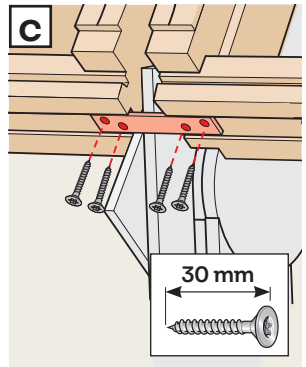
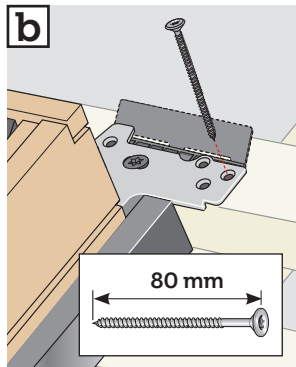
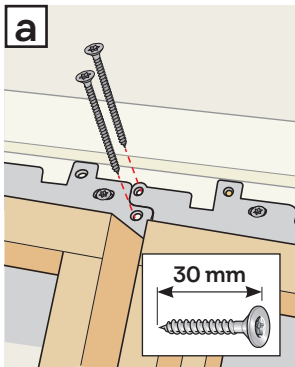
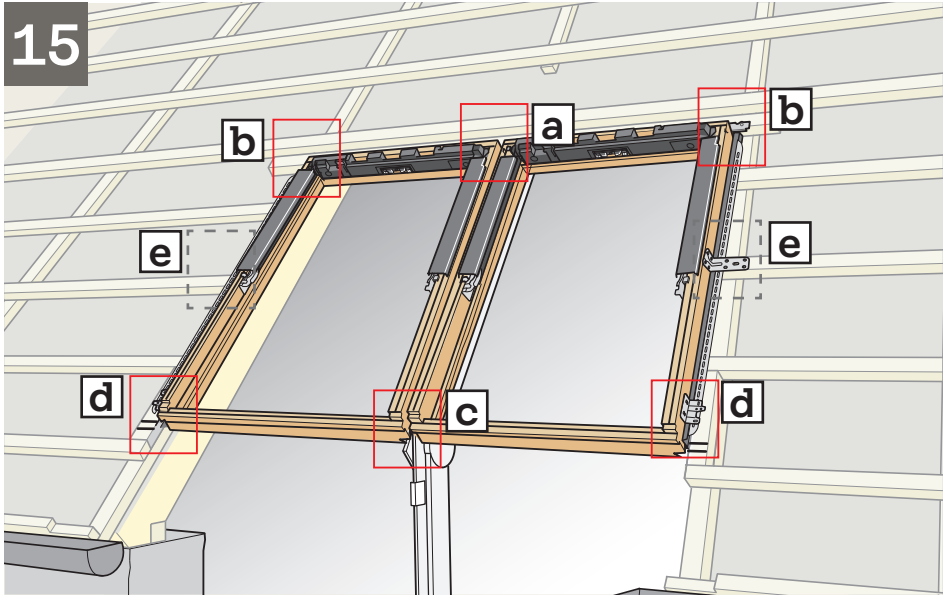

16

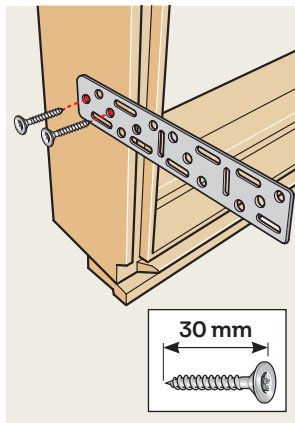
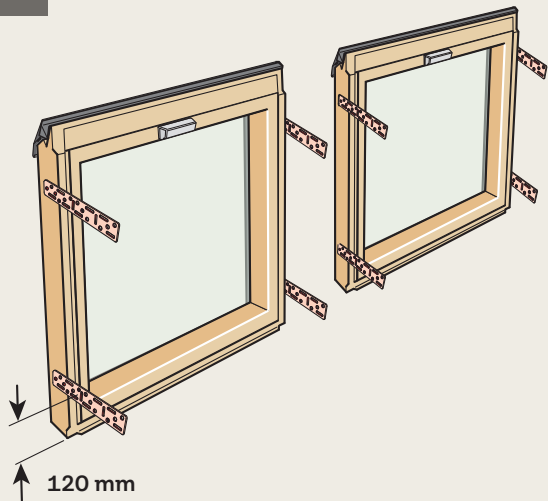

17

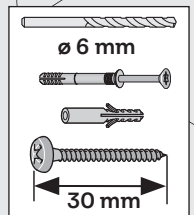
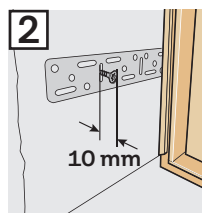
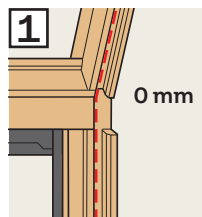
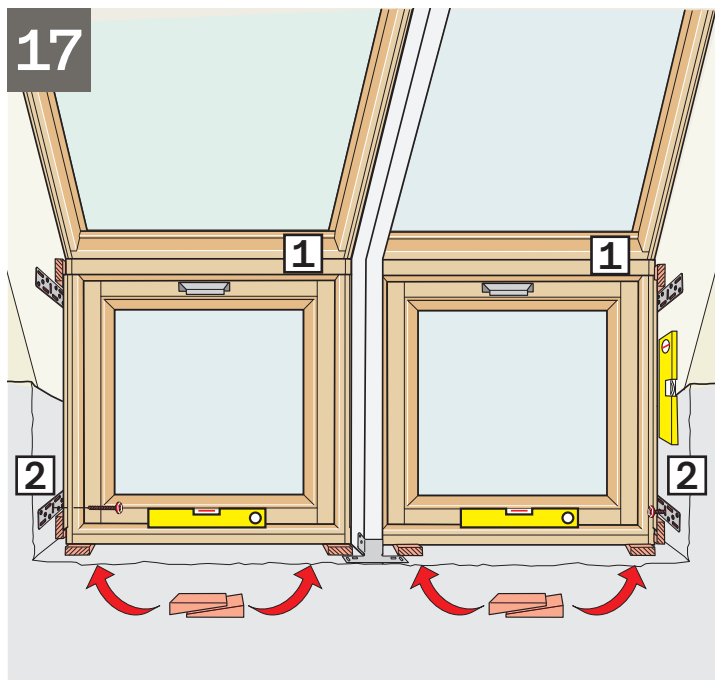

18a VFE

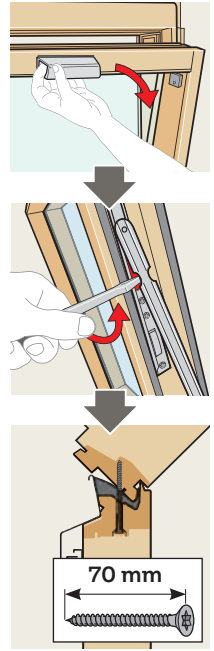
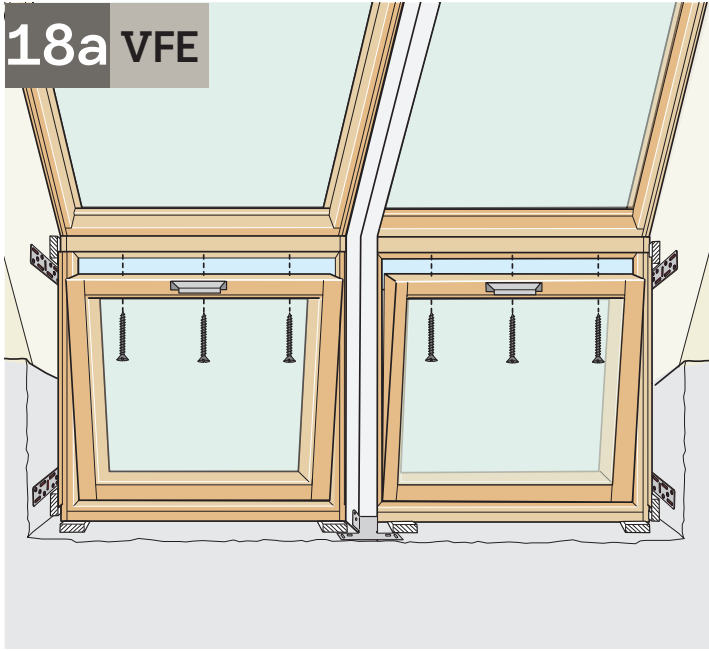

18b VIU

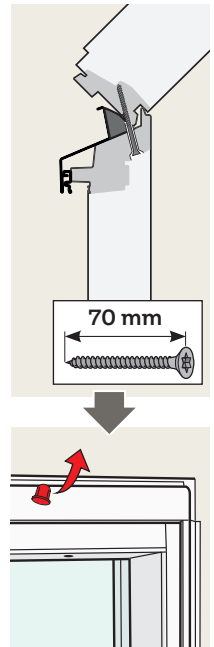
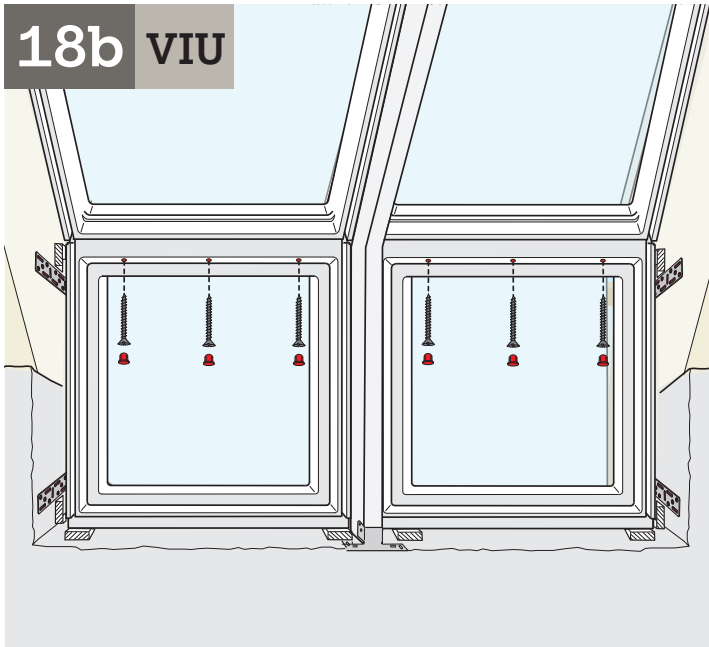

19

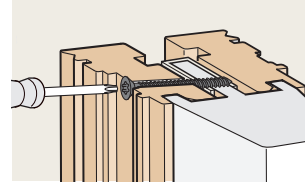
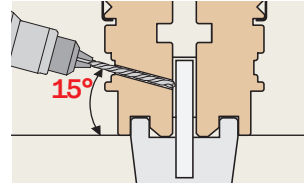
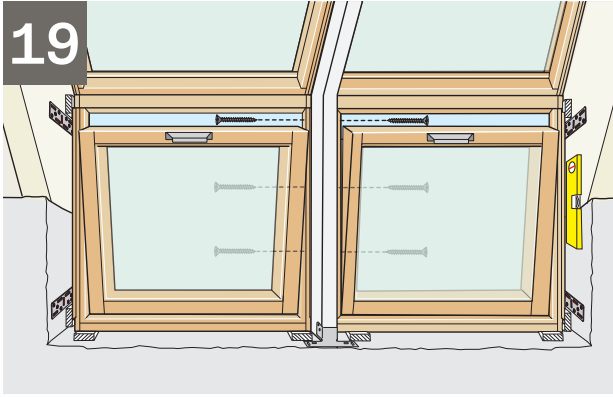

20

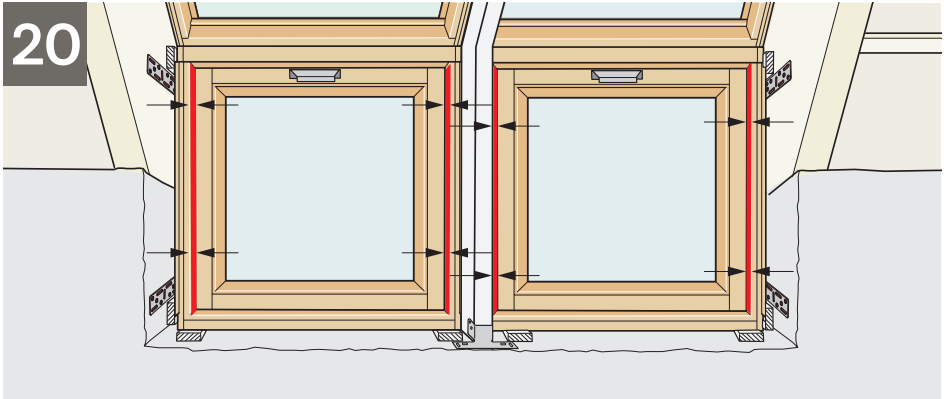

21

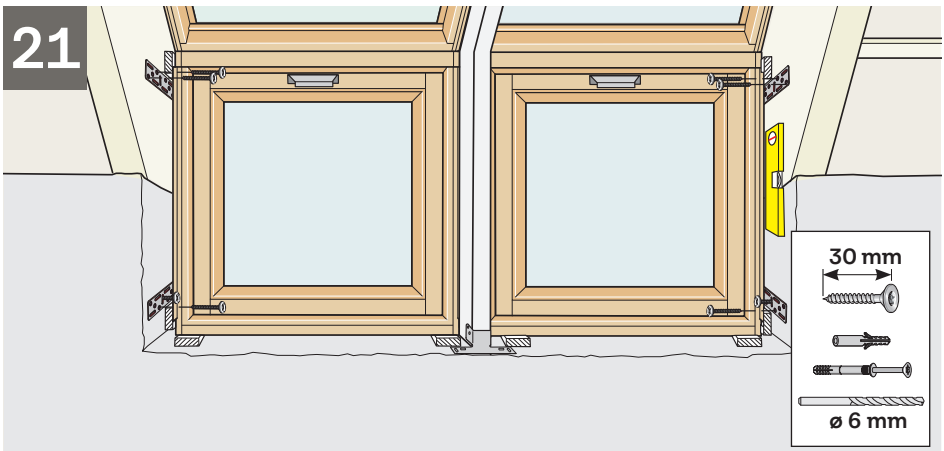

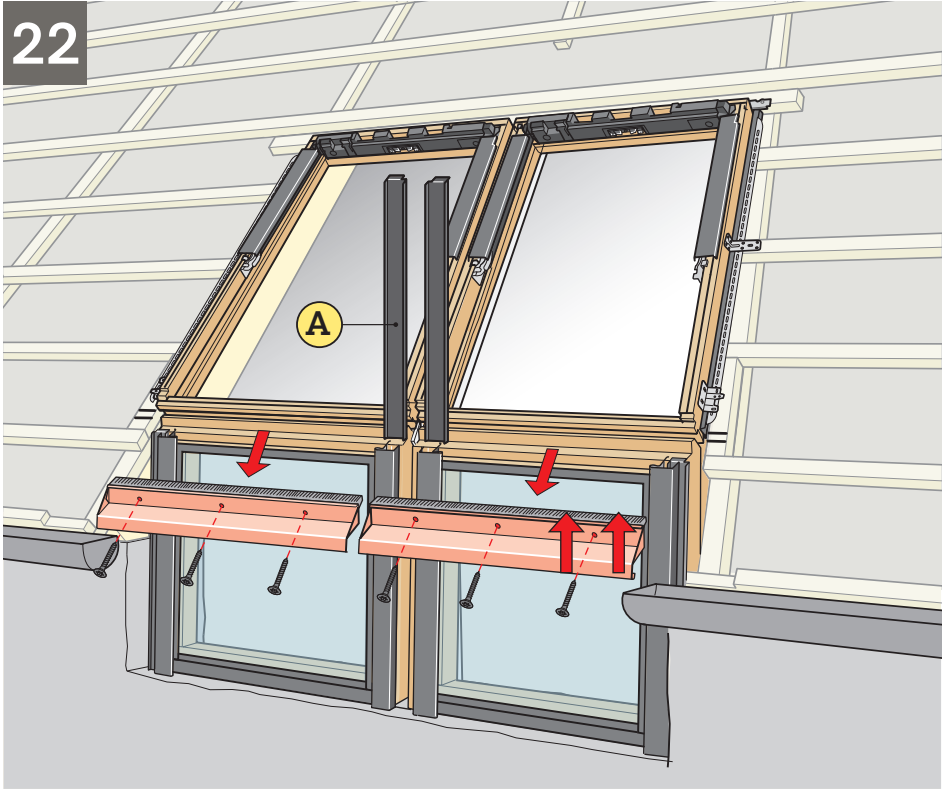

23a

VFE

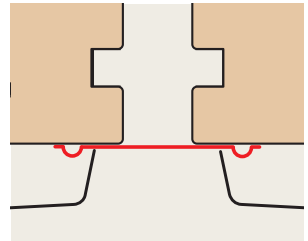
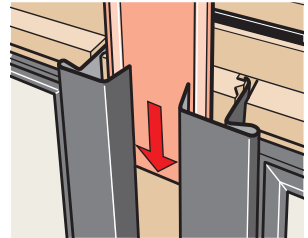
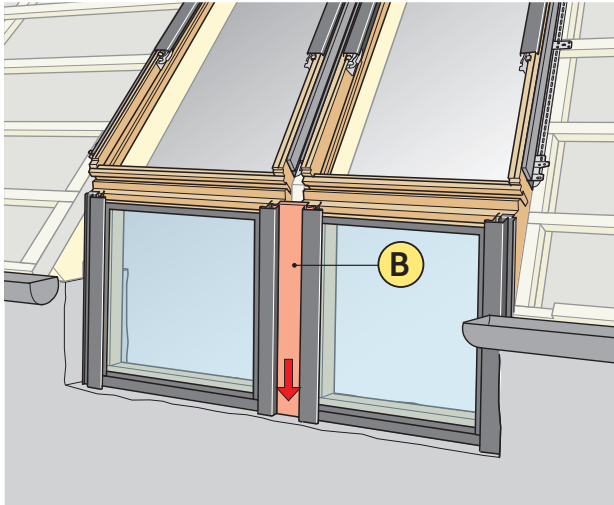
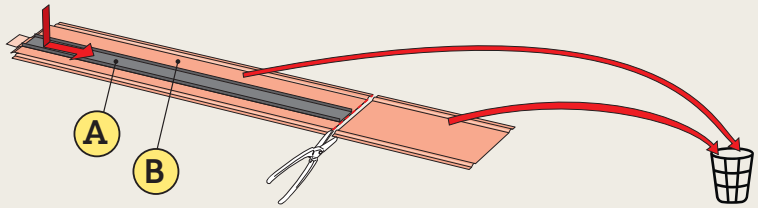

24a

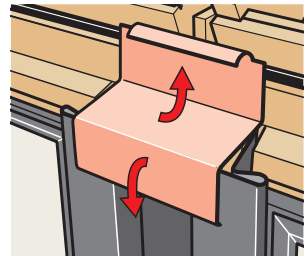
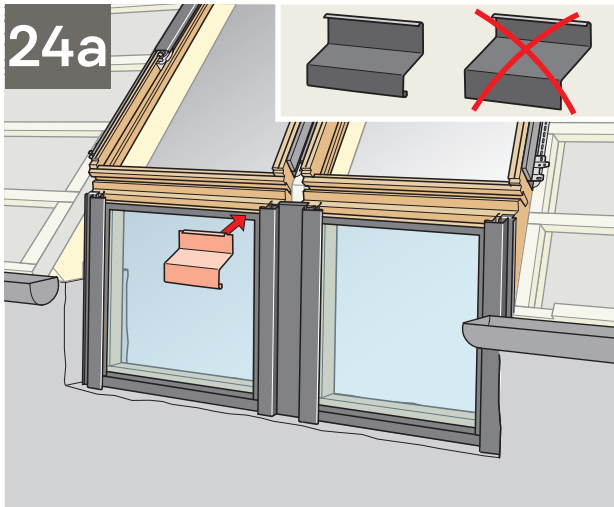

23b

VIU

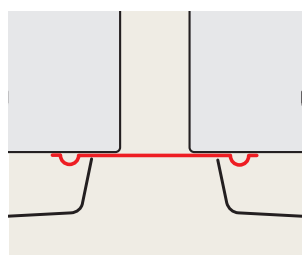
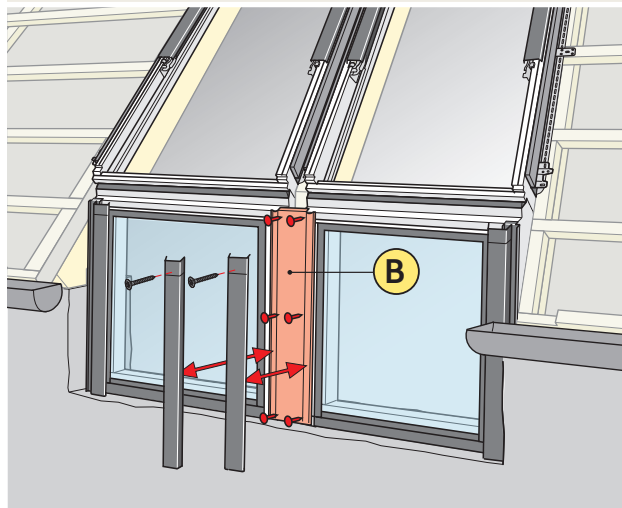
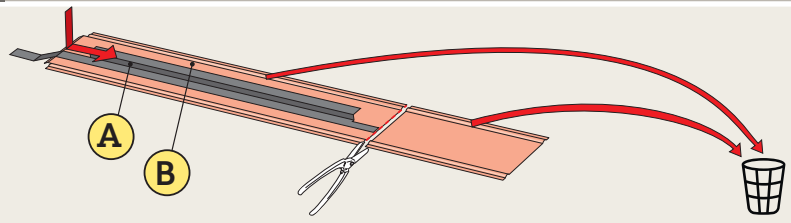

24b

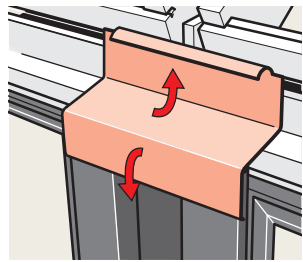
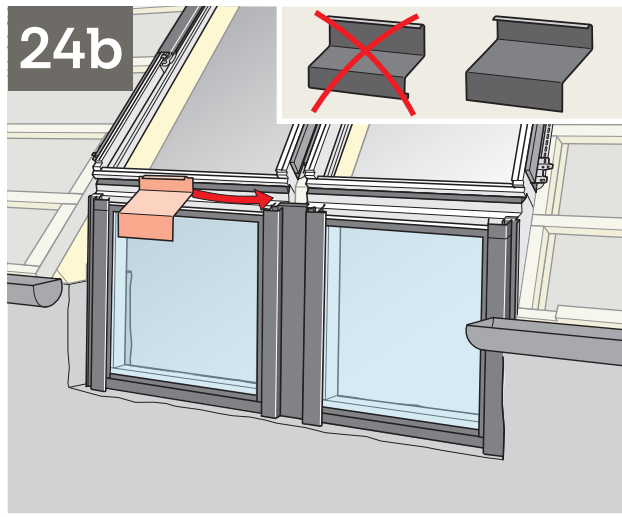
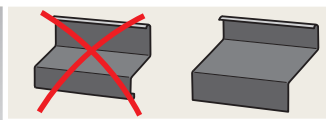

25

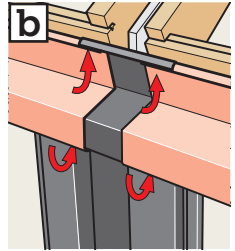
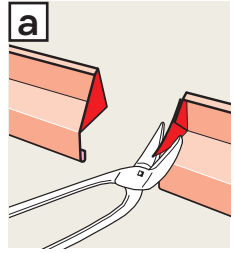
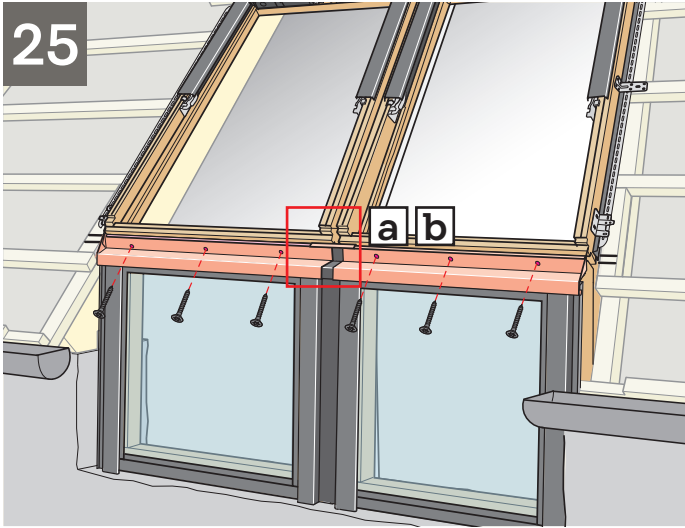

26

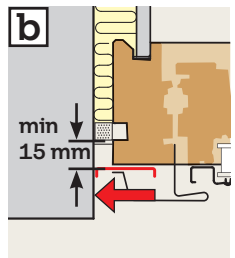
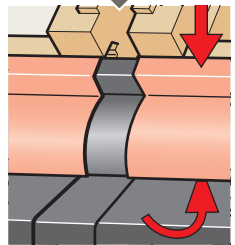
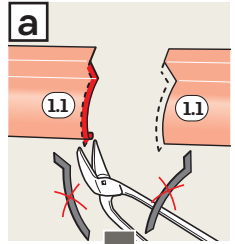
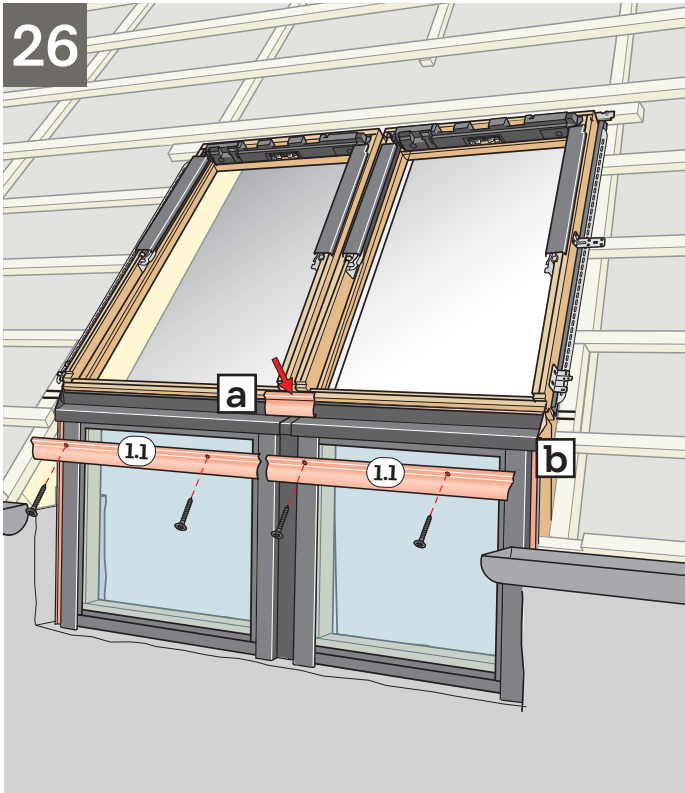

27

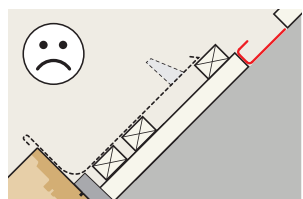
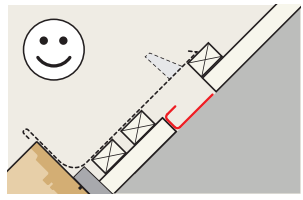
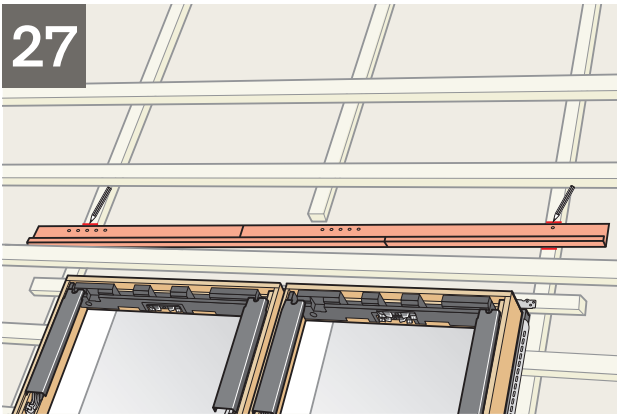

28

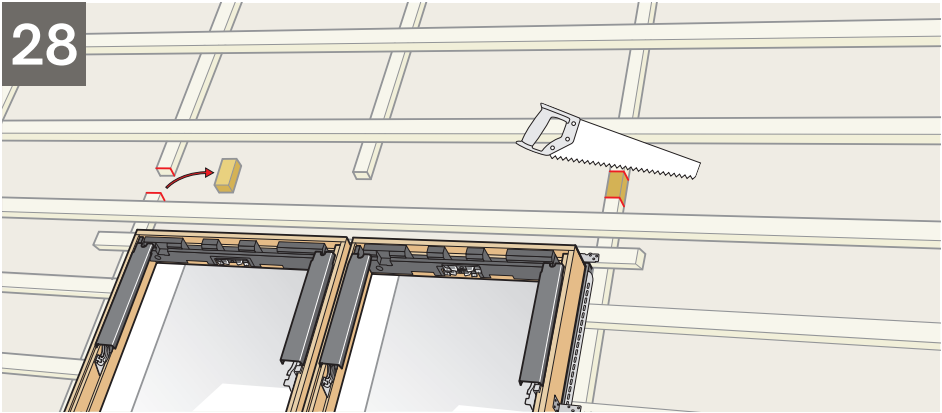

29

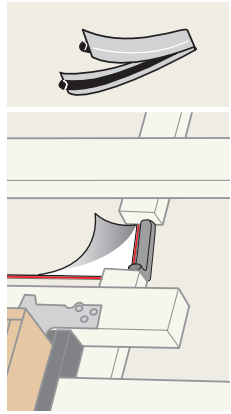
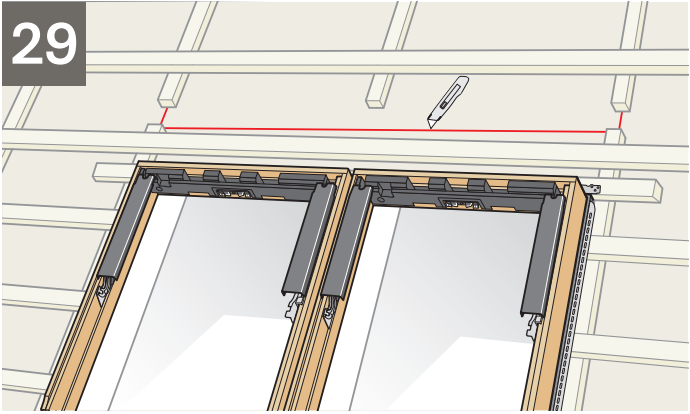

30

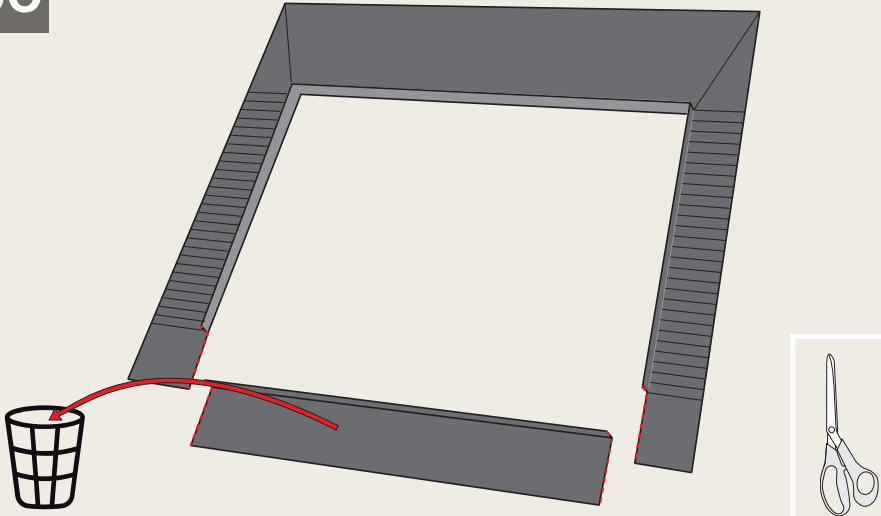

31

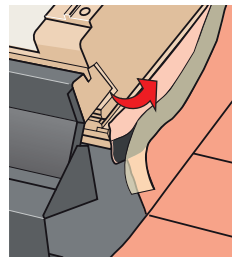
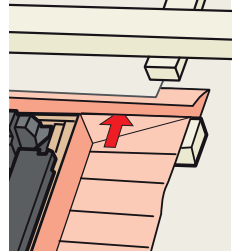

32

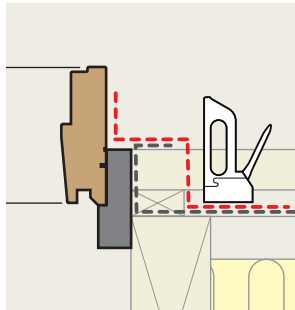
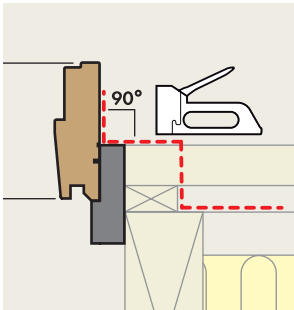
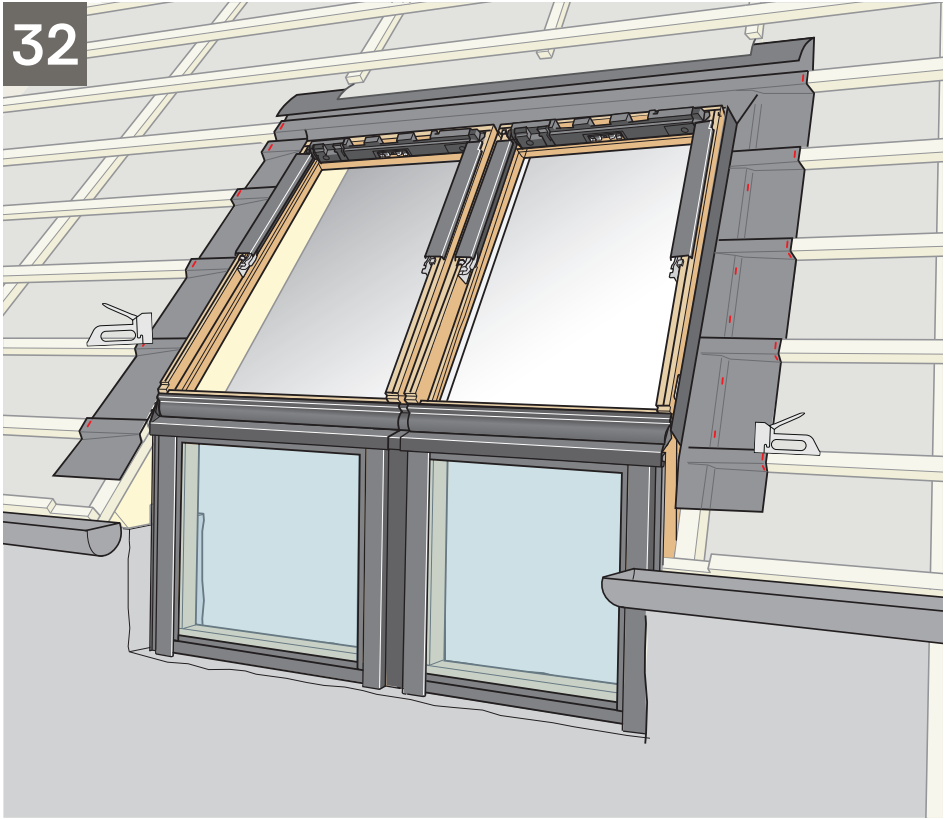

33

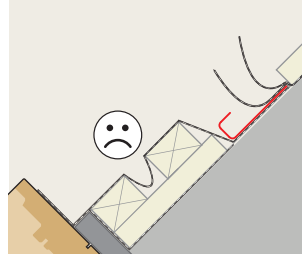
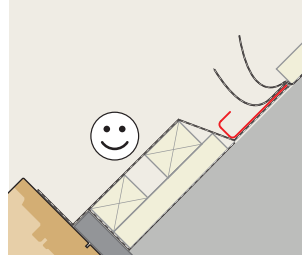
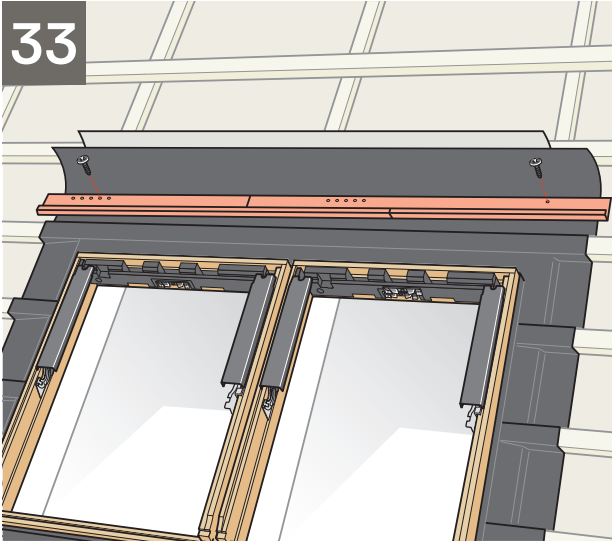

34

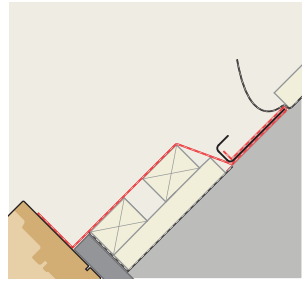
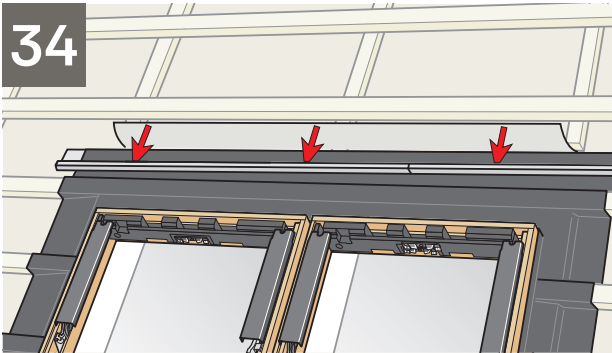

35

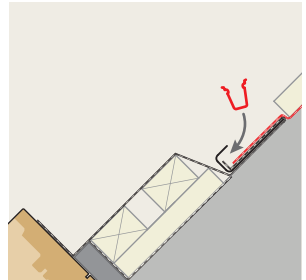
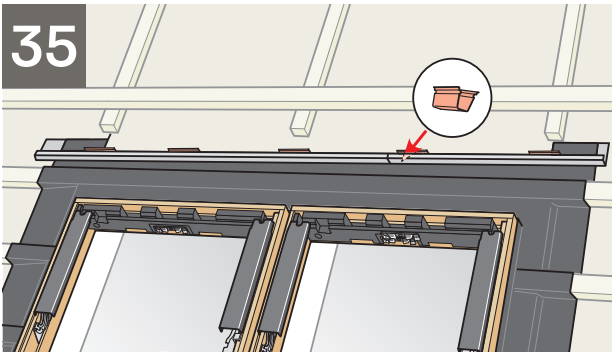

36

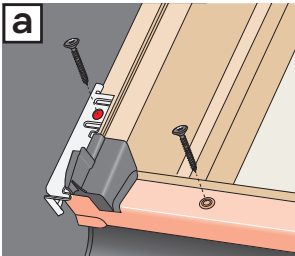
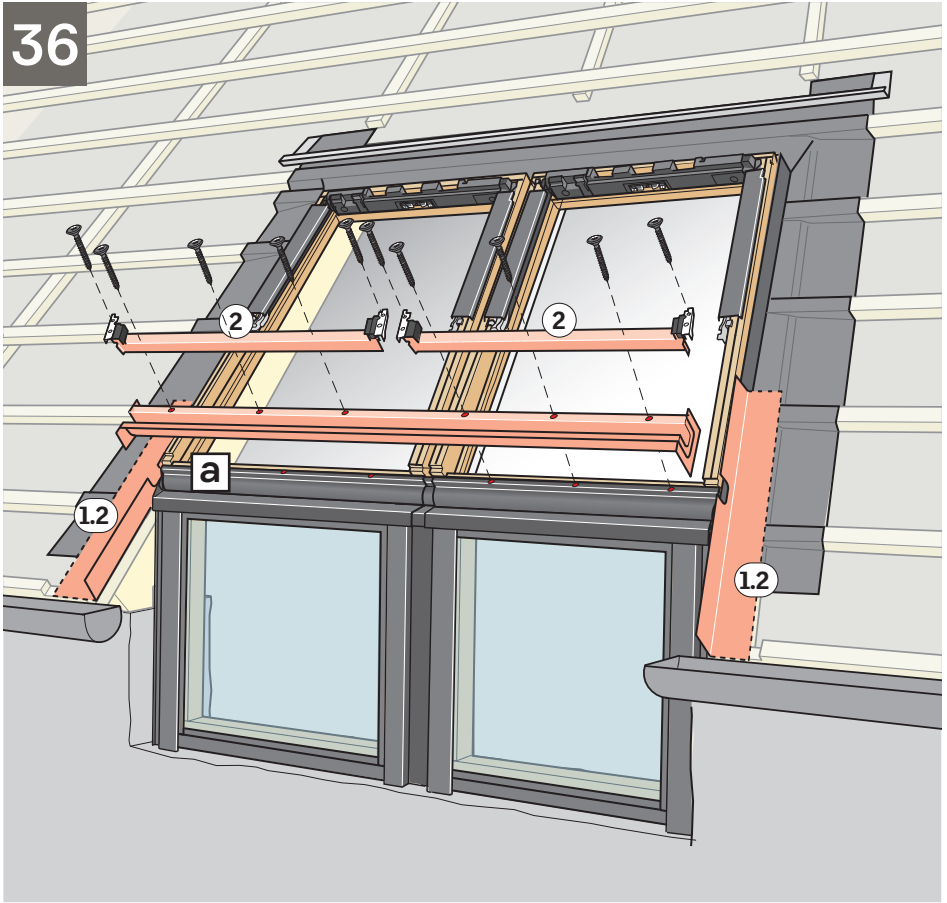

37a

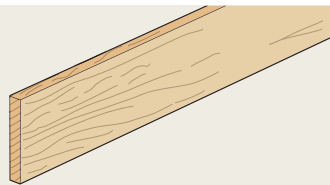
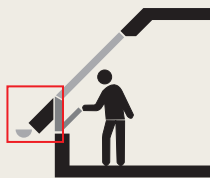

VFE

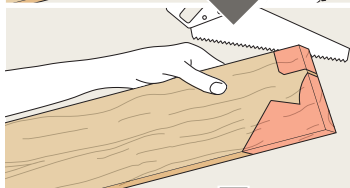
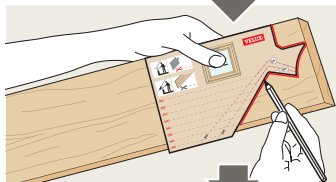
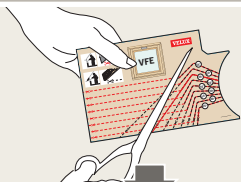

VIU

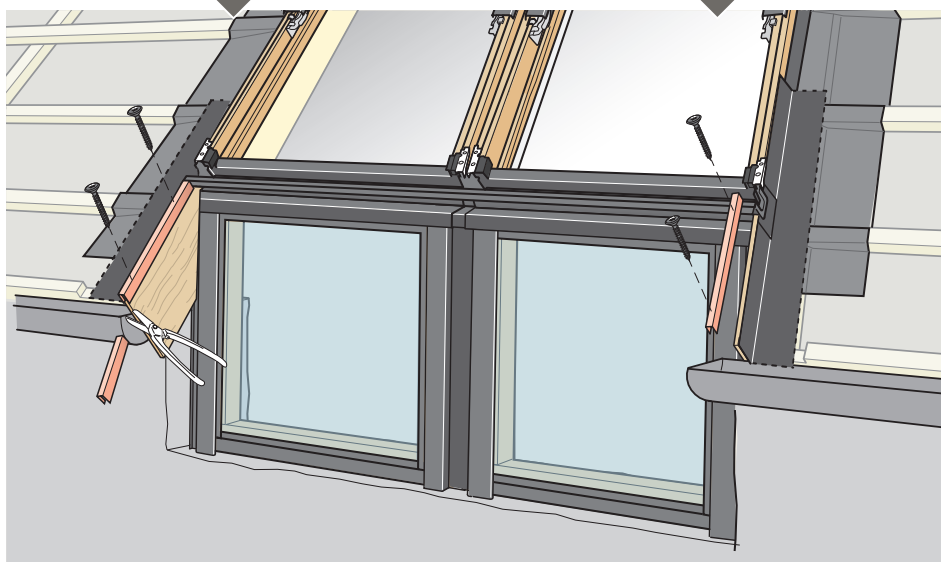
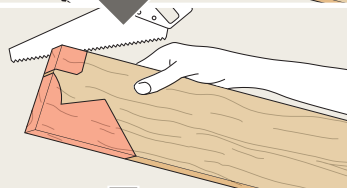
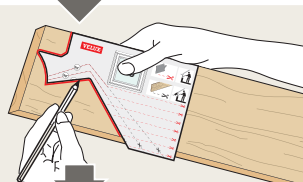
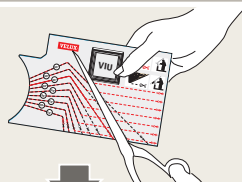

37b

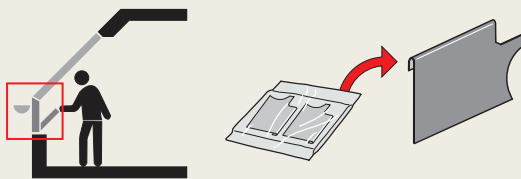

VFE

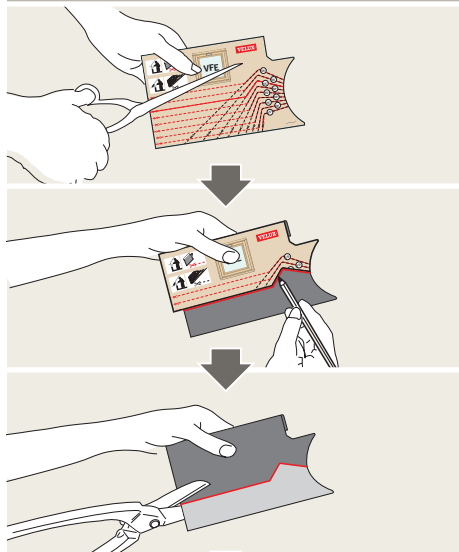

VIU

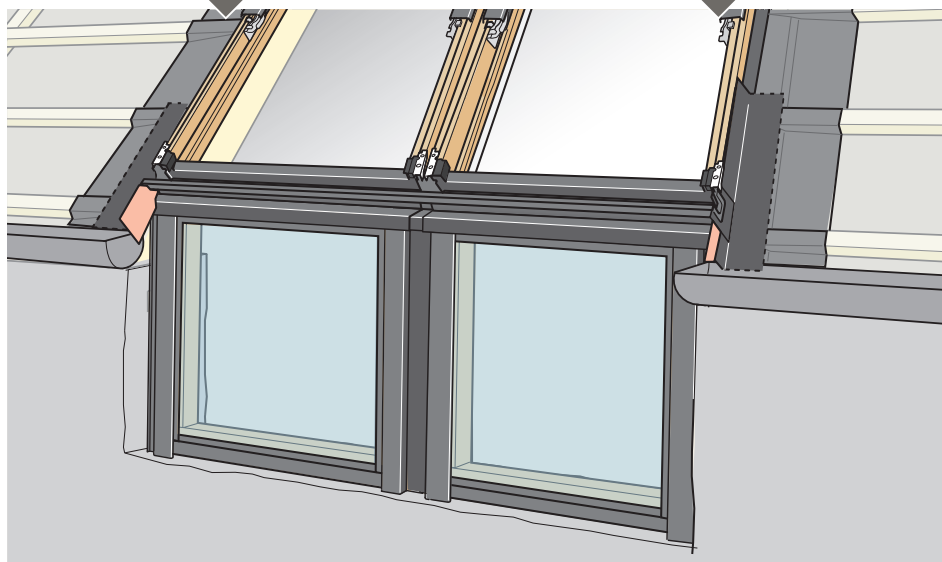
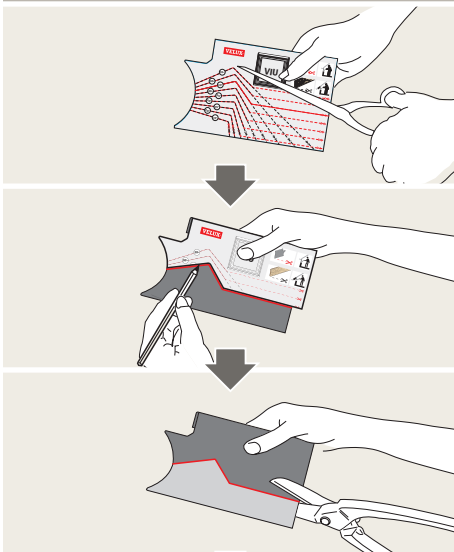

38

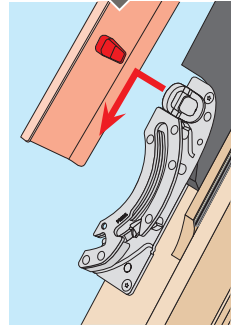
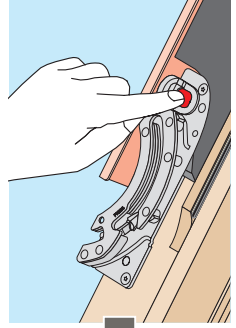
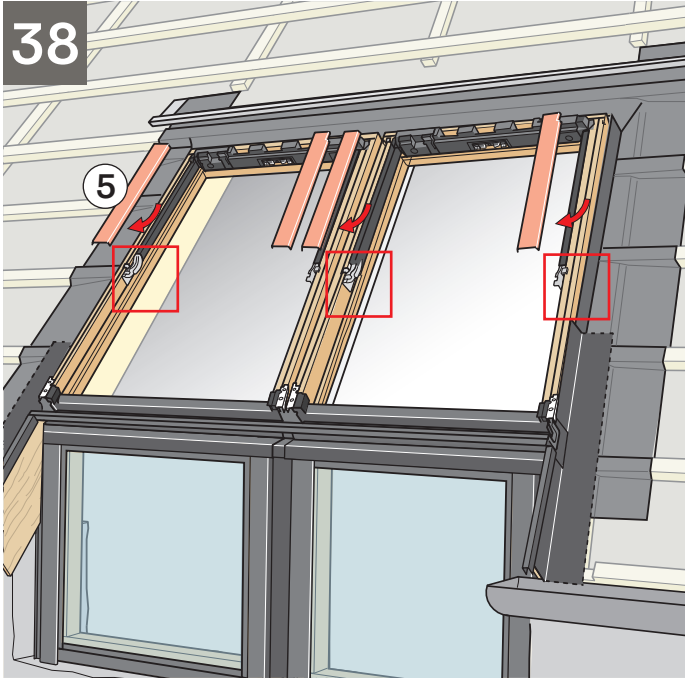

39

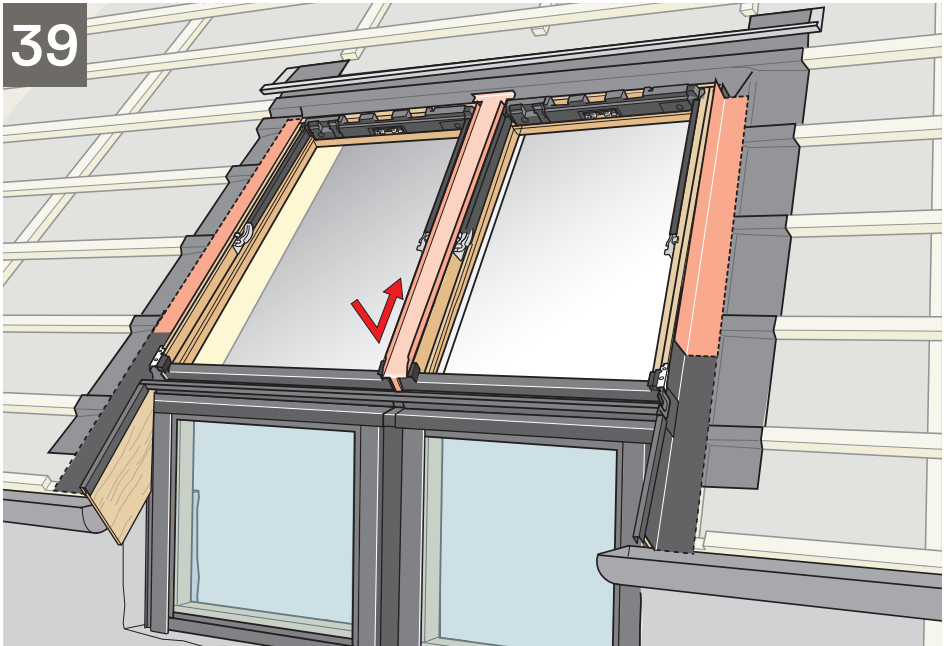

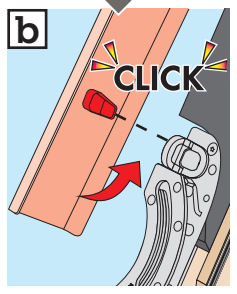
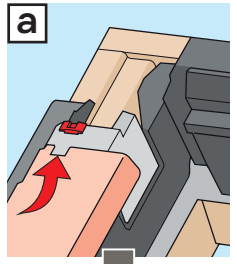
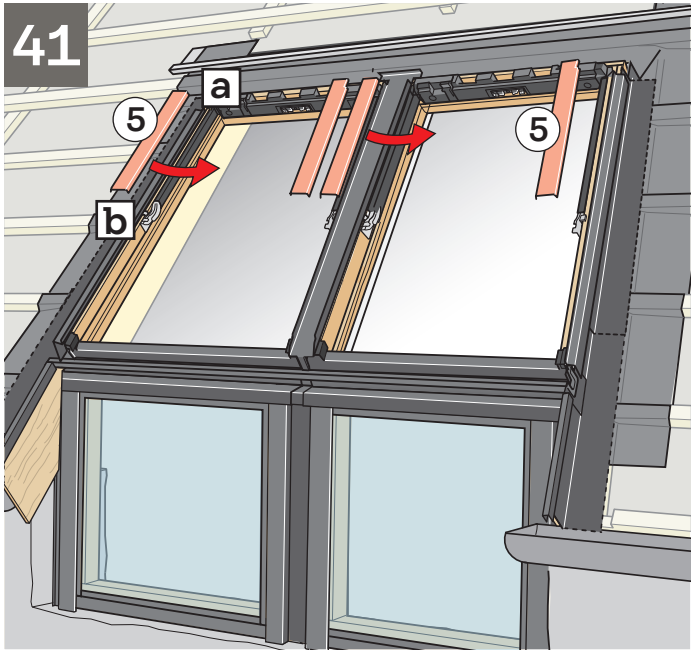
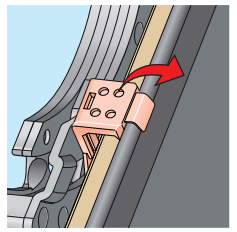
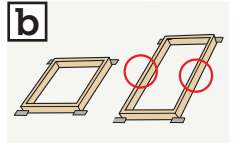
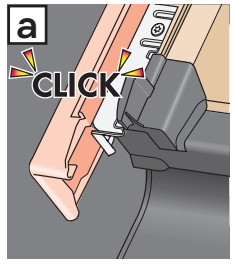
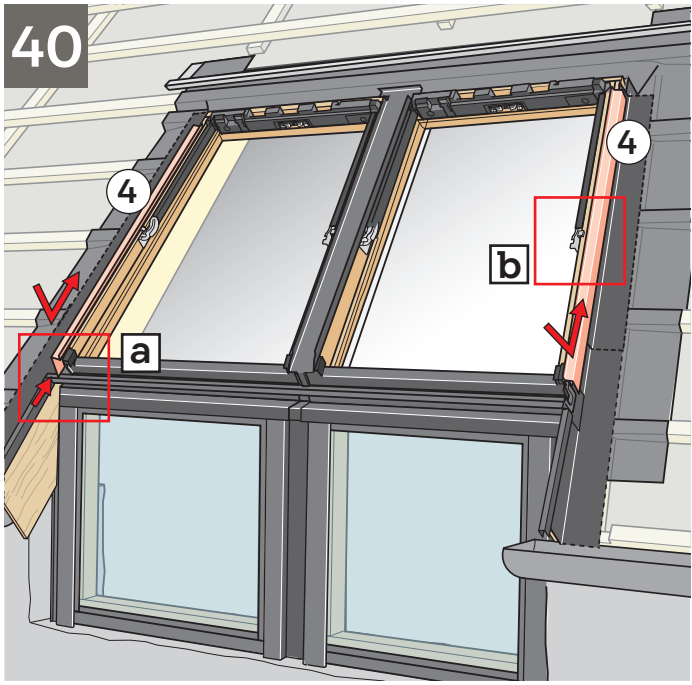

42

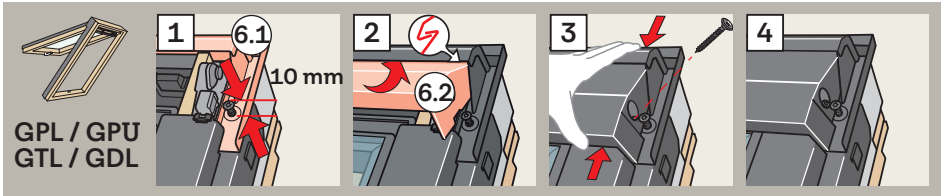
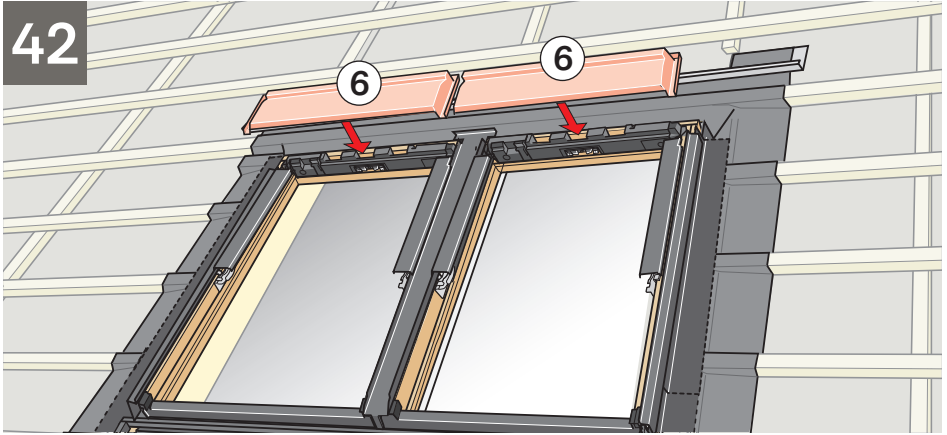

43

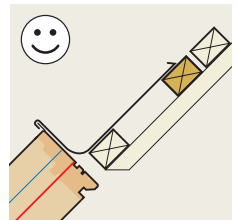
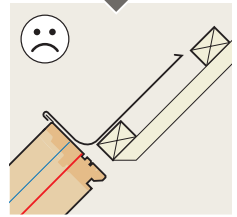
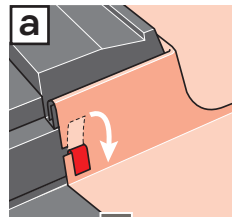
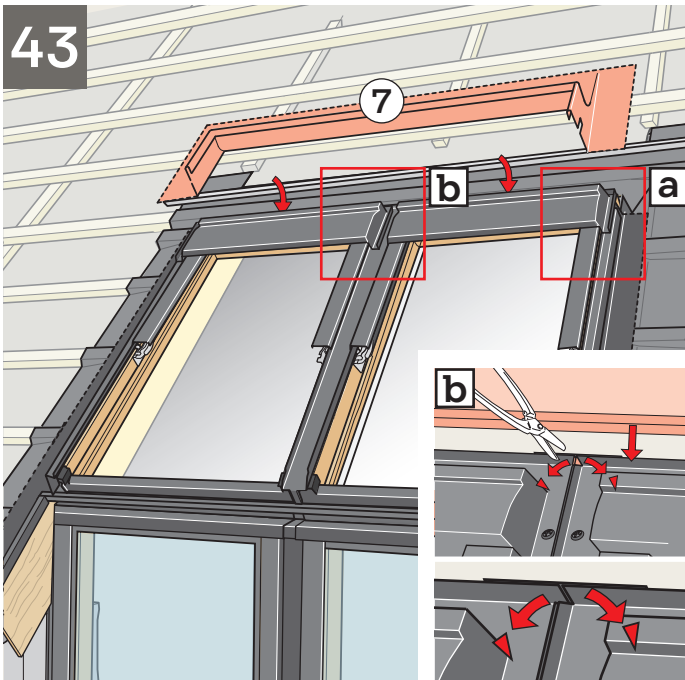

44

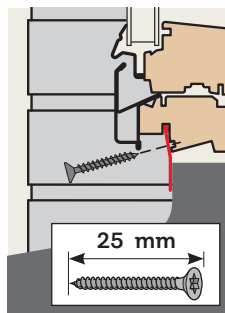
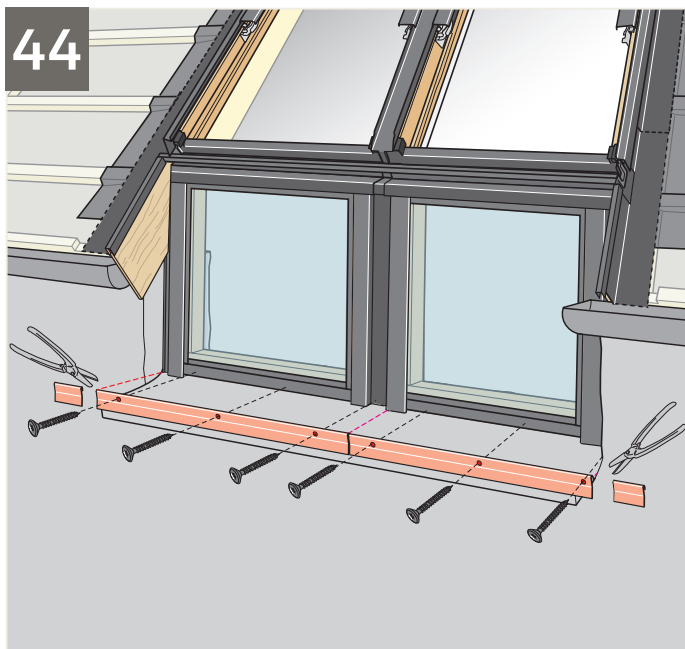

- AR:** VELUX Export (VELUX A/S)
+ 45 4516 7885
- AT:** VELUX Österreich GmbH
02245/32 3 50
- AU:** VELUX Australia Pty. Ltd.
1300 859 856
- BA:** VELUX Bosna i Hercegovina d.o.o.
033/626 493, 626 494
- BE:** VELUX Belgium
(010) 42.09.09
- BG:** ВЕЛУКС България ЕООД
02/955 99 30
- CA:** VELUX Canada Inc.
1 800 88-VELUX (888-3589)
- CH:** VELUX Schweiz AG
062 289 44 45
- CL:** VELUX Export (VELUX A/S)
+ 45 4516 7885
- CN:** VELUX (CHINA) CO. LTD.
0316-607 27 27
- CZ:** VELUX Česká republika, s.r.o.
531 015 511
- DE:** VELUX Deutschland GmbH
www.velux.de/kontakt
- DK:** VELUX Danmark A/S
45 16 45 16
- EE:** VELUX Eesti OÜ
621 7790
- ES:** VELUX Spain, S.A.U.
91 509 71 00
- FR:** VELUX France
0806 80 15 15
Service gratuit + prix appel
- GB:** VELUX Company Ltd.
01592 778 225
- HR:** VELUX Hrvatska d.o.o.
01/5555 444
- HU:** VELUX Magyarországn Kft.
(06/1) 436-0601
- IE:** VELUX Company Ltd.
01 848 8775
- IT:** VELUX Italia s.p.a.
045/6173666
- JP:** VELUX-Japan Ltd.
0570-00-8141
- KR:** VELUX Export (VELUX A/S)
+ 45 4516 7885
- LT:** VELUX Lietuva, UAB
(85) 270 91 01
- LV:** VELUX Latvia SIA
67 27 77 33
- NL:** VELUX Nederland B.V.
030 - 6 629 629
- NO:** VELUX Norge AS
22 51 06 00
- NZ:** VELUX New Zealand Ltd.
0800 650 445
- PL:** VELUX Polska Sp. z o.o.
(022) 33 77 000 / 33 77 070
- PT:** VELUX Portugal, Lda
21 880 00 60
- RO:** VELUX România S.R.L.
0268-402740
- RS:** VELUX Srbija d.o.o.
011 20 57 500
- SE:** VELUX Svenska AB
042/20 83 80
- SI:** VELUX Slovenija d.o.o.
01 724 68 68
- SK:** VELUX Slovensko, s.r.o.
(02) 33 000 555
- TR:** VELUX Çatı Pencerelei
Ticaret Limited Şirketi
0 216 302 54 10
- UA:** ТОВ "ВЕЛІОКС Україна"
(044) 2916070
- US:** VELUX America LLC
1-800-88-VELUX