

GIL/GIU

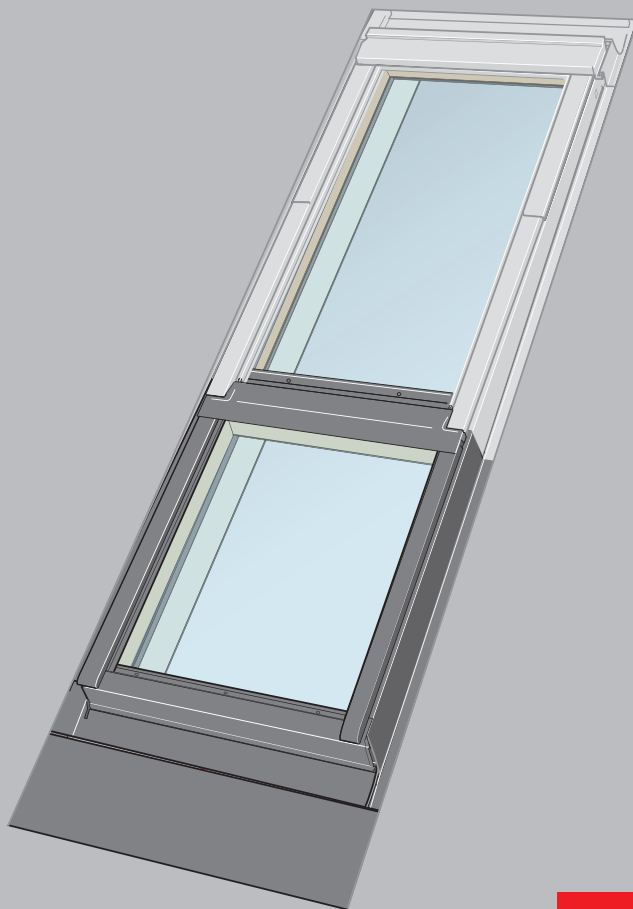

VELUX®

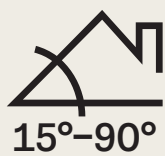

VAS 453281-2026-03



EDW

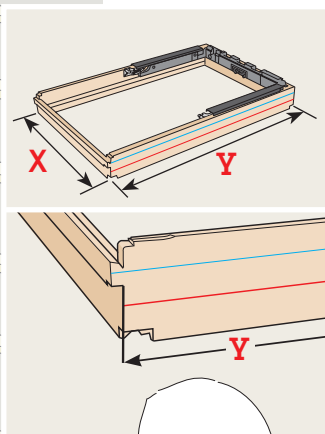
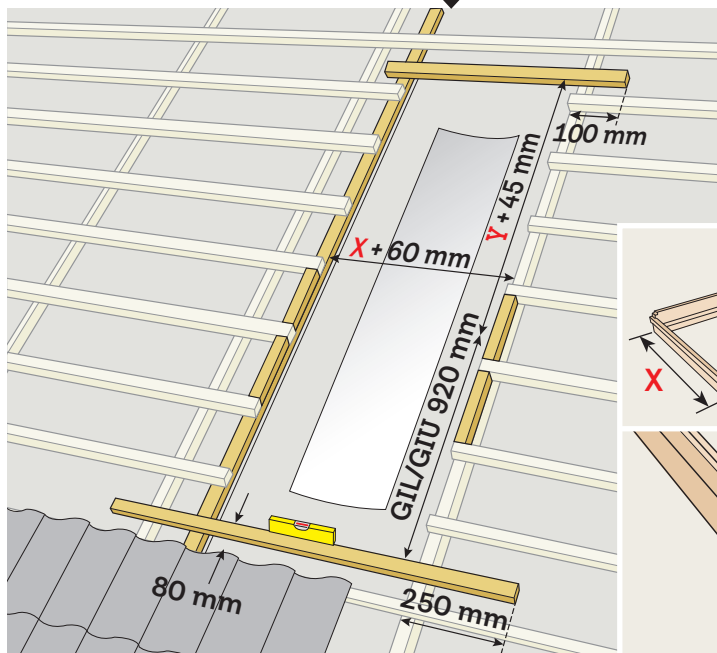

1

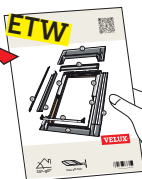

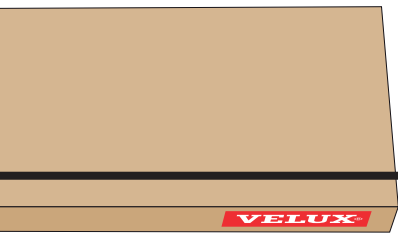
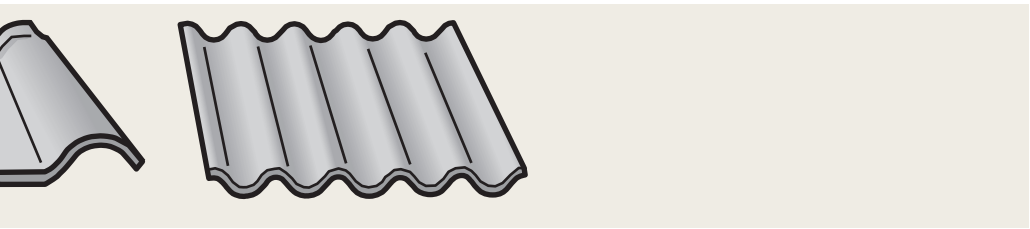

**EDJ +
ETJ**

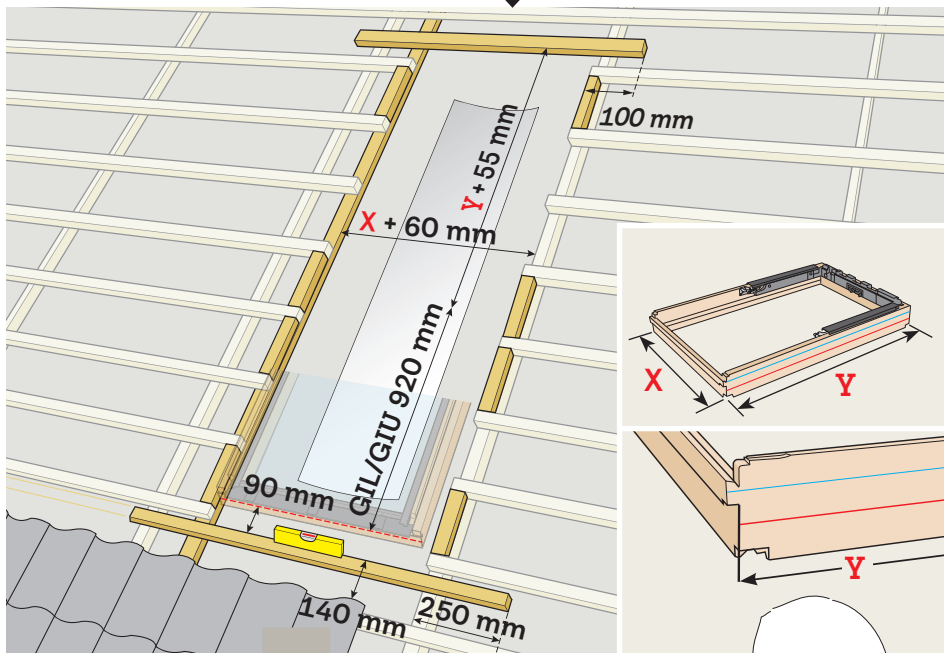

1

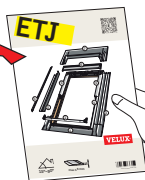

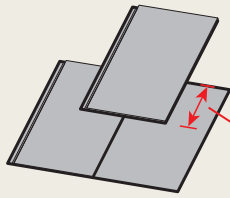

50-120 mm

**EDT +
ETW**

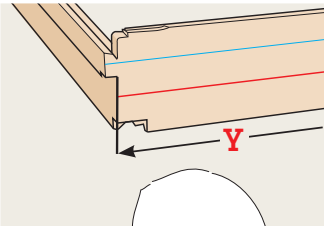
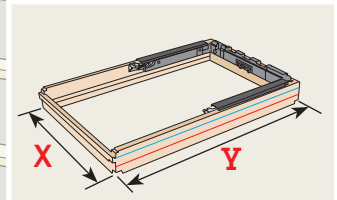
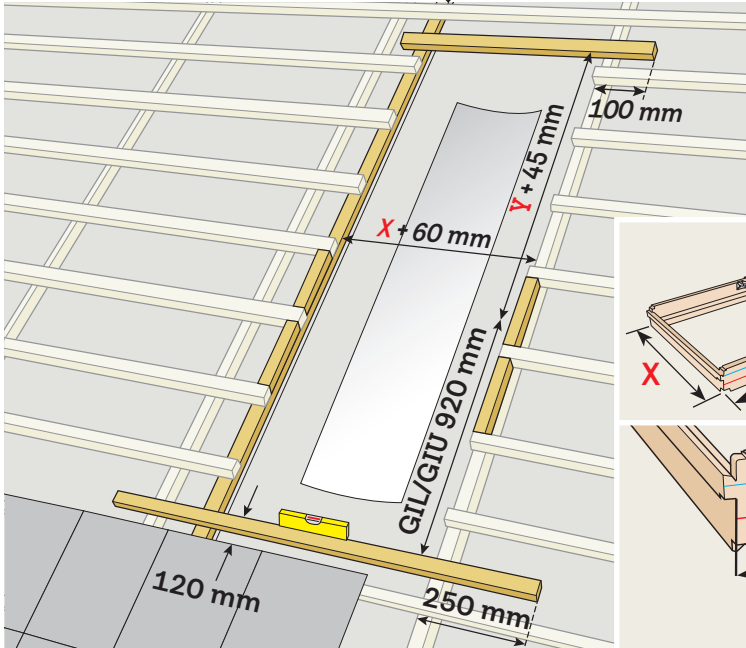

1

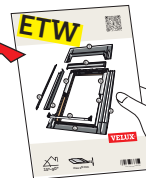

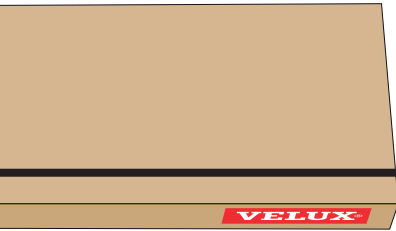
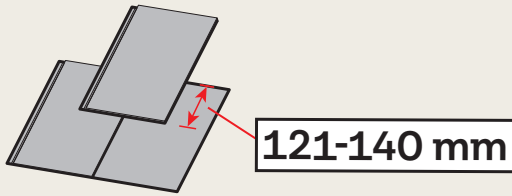

**EDT +
ETW**

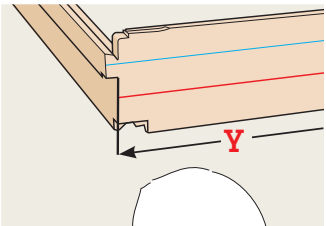
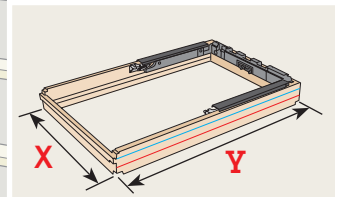
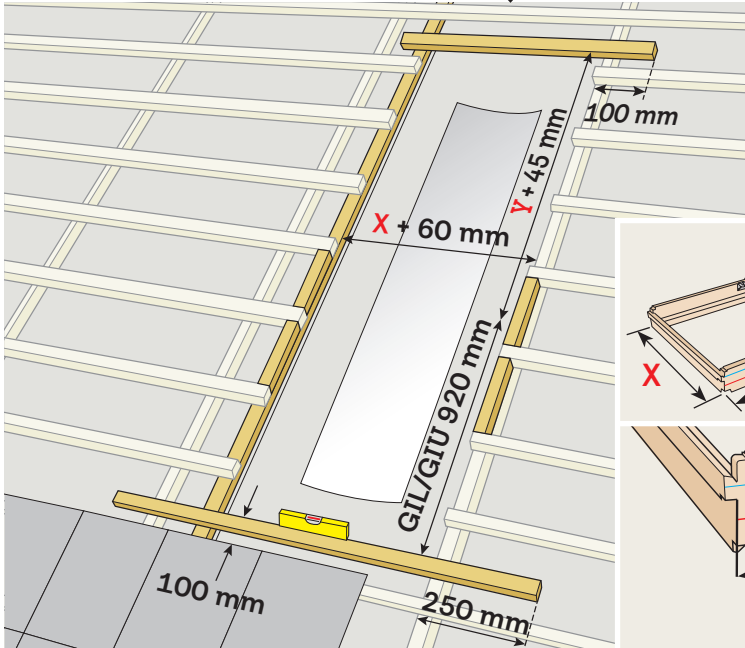

1

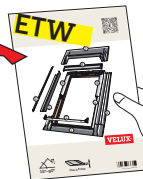

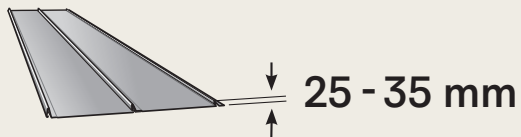

**EDQ-L +
ETQ-L**

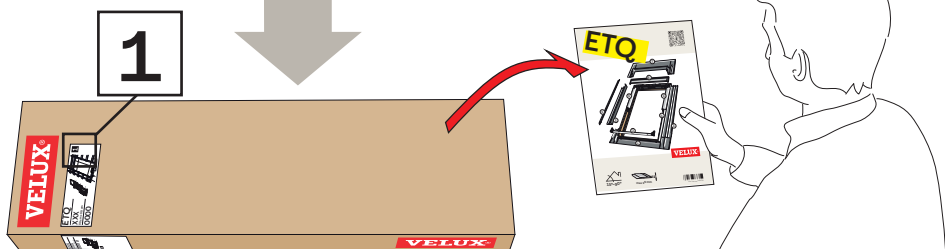
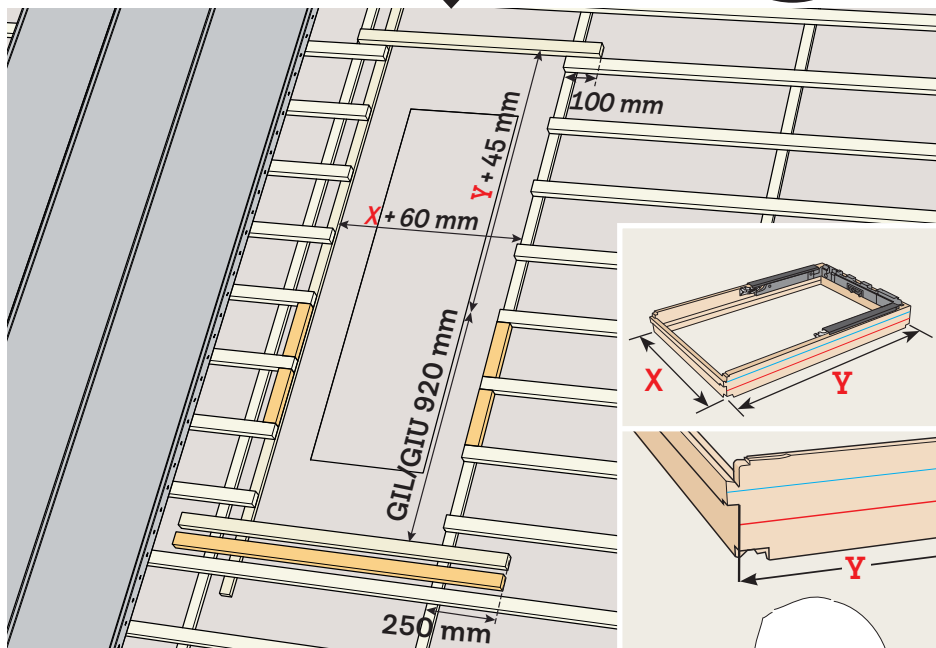

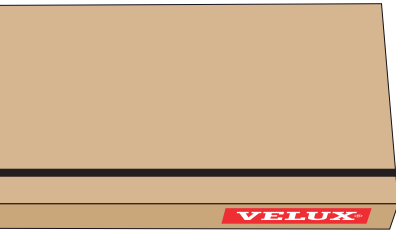
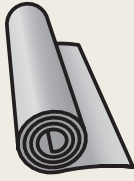

**EDR +
ETR**

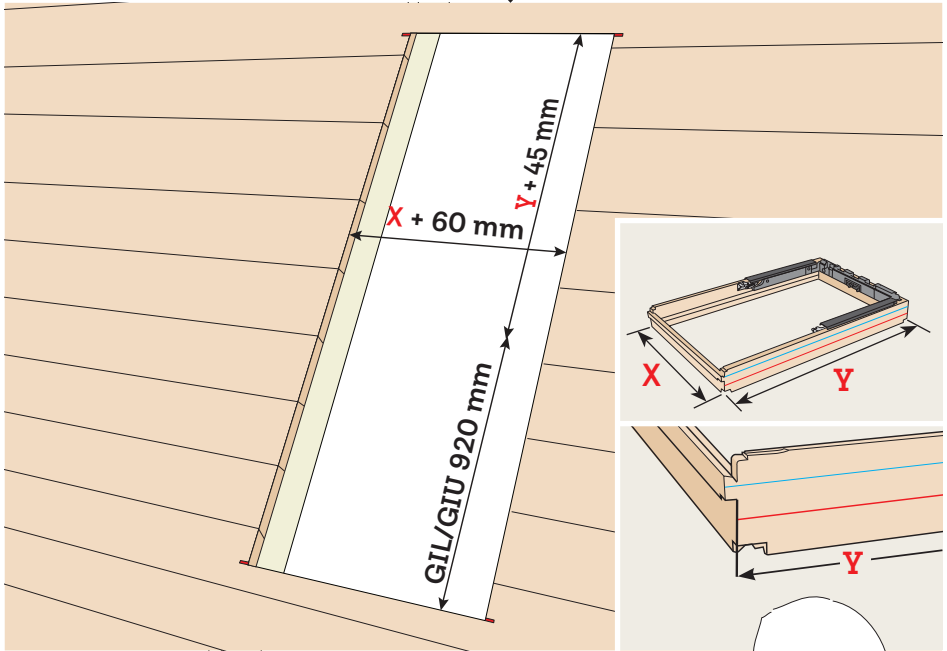

1

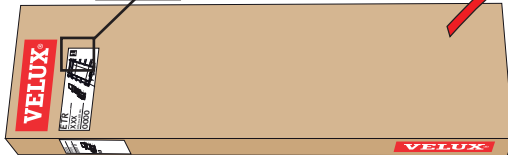

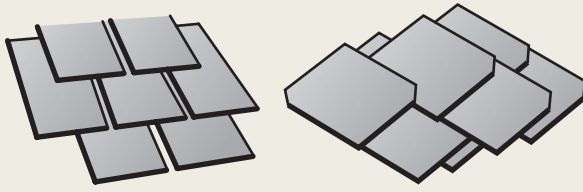

**EDL/EDS +
ETL/ETS**

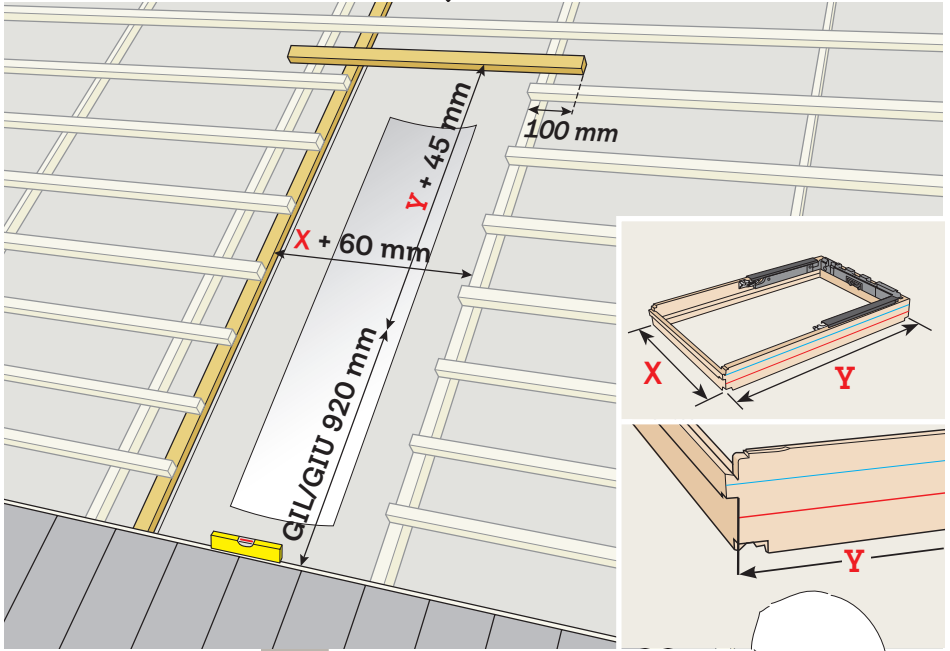

1



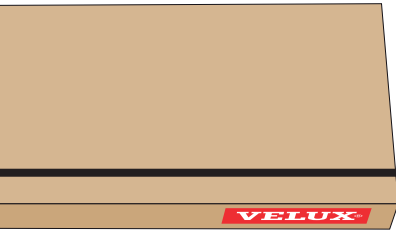
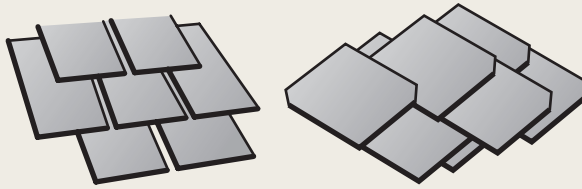

**EDN +
ETN**

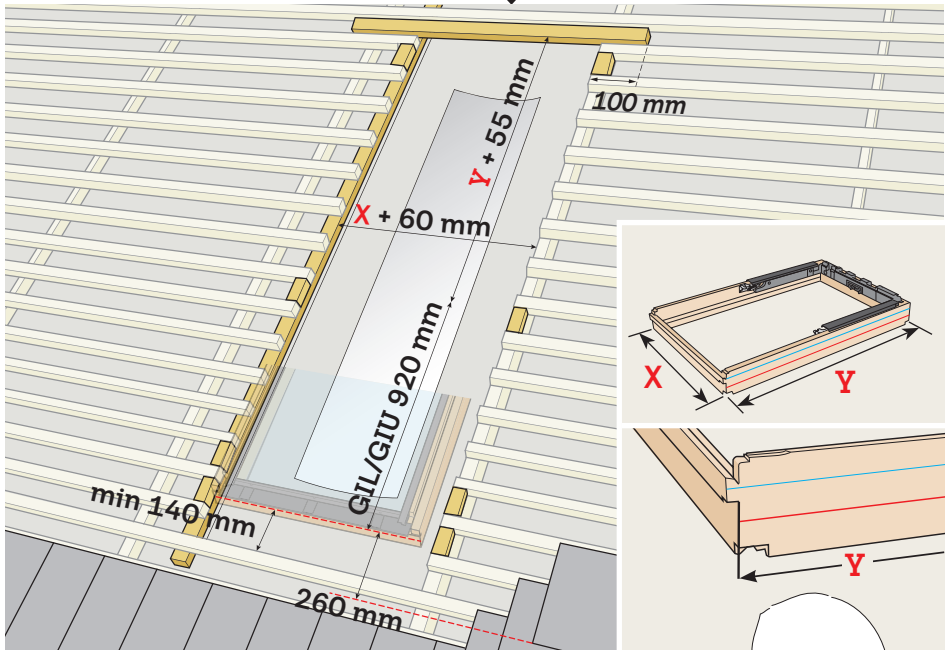

1



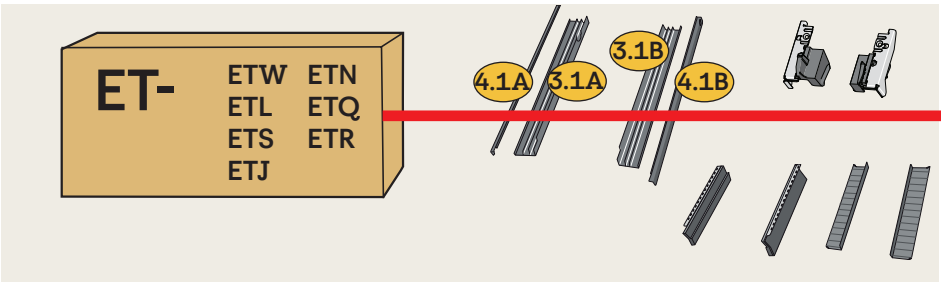
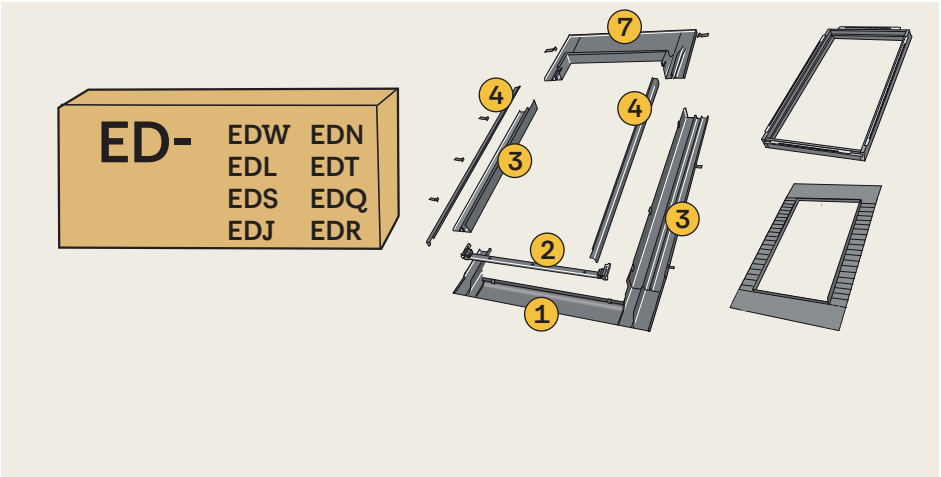
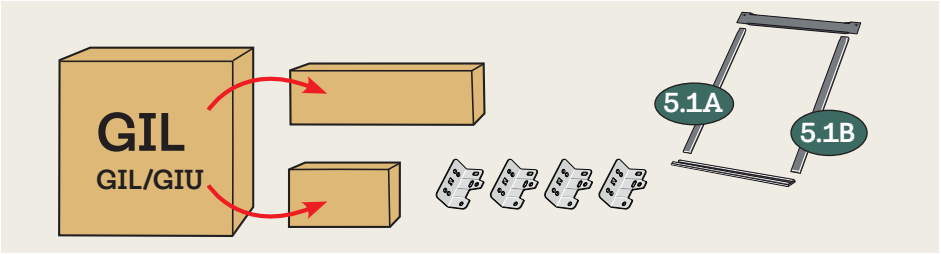
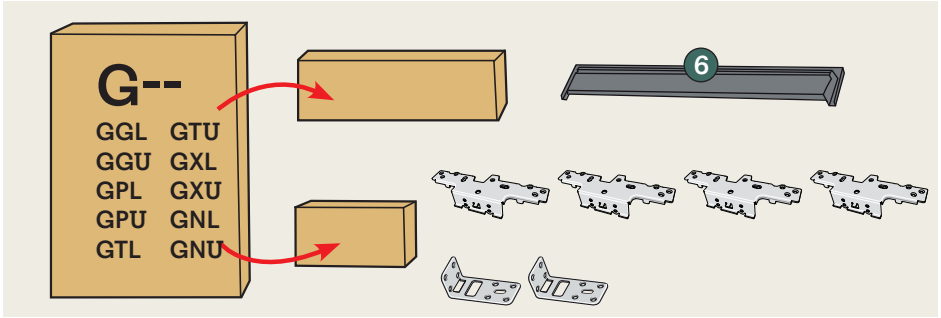

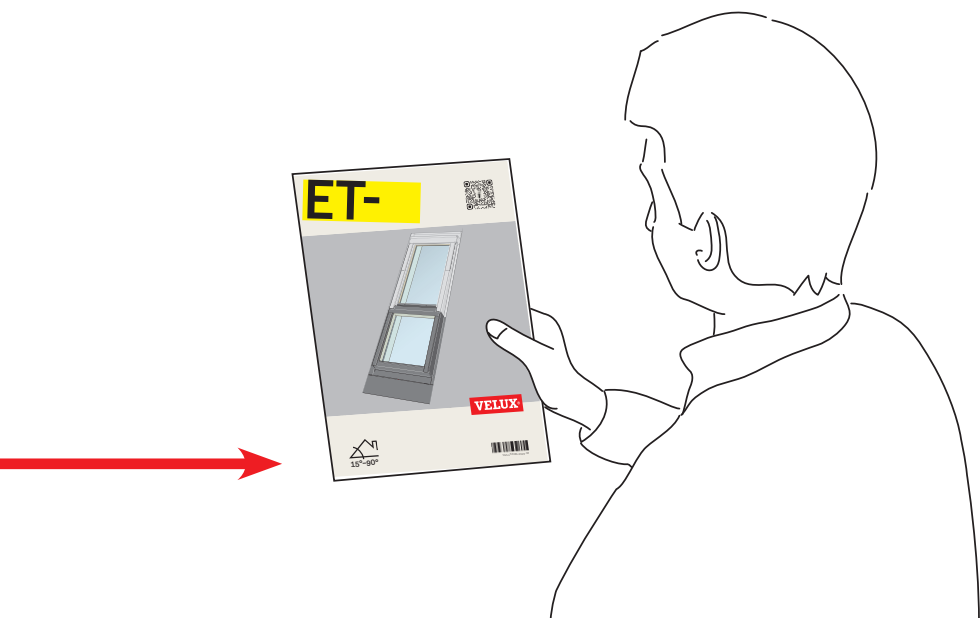



www.velux.com



velux.com/contact

INSTALLATION INSTRUCTIONS FOR G.LL.GIU. © 2012, 2026 VELUX GROUP © VELUX AND THE VELUX LOGO ARE REGISTERED TRADEMARKS USED UNDER LICENCE BY THE VELUX GROUP