

VELUX®

Commercial

VELUX Modular Skylights

Technical Handbook

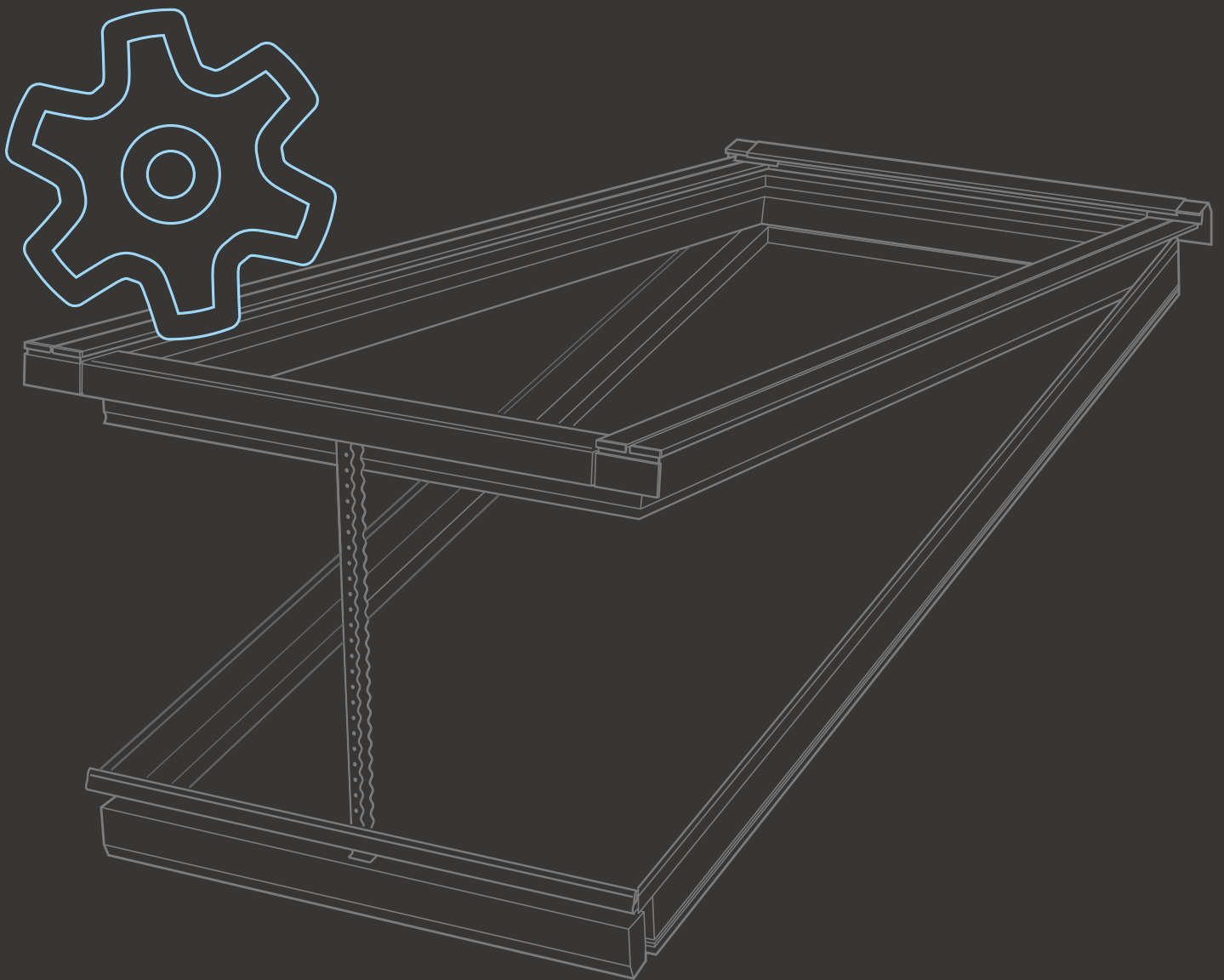



DZNE: German Center for Neurodegenerative Diseases, Germany, 2016
Ridgelight at 5° with Beams
Photographer: STORM Production





VELUX Modular Skylights

VELUX Modular Skylights are sash-frame constructed single roof windows with a high-insulating glazing unit. The modules are available as both fixed and venting skylights. All individual skylights are delivered as prefabricated modules with dedicated factory finished flashings to ensure watertightness in every solution.

VELUX Modular Skylights roof windows are CE-marked in accordance with the harmonized standard EN 14351-1 – Windows and doors.

Fire resistant modules are CE-marked in accordance with the EAD 220116-00-0401 of 2018-12 as relevant harmonized technical specification and the essential characteristics are expressed in accordance with the ETA-19/0027 of 2019-03-11.

The self-supporting Ridgelights are CE-marked in accordance with the European Assessment Document EAD 220013-01-0401 of 2017-03 as relevant harmonized technical specification.

The load bearing capacity performance of the self-supporting Ridgelights is expressed in the European Technical Assessment ETA 17/0476 of 2019-01-28.

In addition, the skylight modules have been tested and approved in accordance with EN 12101-2 – Smoke and heat control systems Part 2: Specification for natural smoke and heat exhaust ventilators.

VELUX Modular Skylights has a reference service life of 30 years in accordance with EN 17213.

This technical handbook for VELUX Modular Skylights describes the product characteristics and performance of the skylight module together with sun screening and control system.

For real life case studies and inspiration, please refer to: veluxcommercial.com

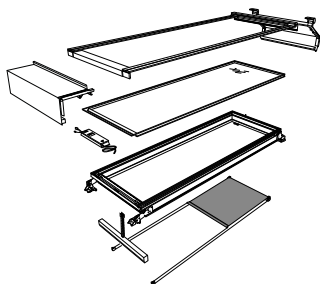

Modular System 7

- Skylight module 8
- Functions & sizes / Size grid 8
- How to measure the modules 10
- Solutions 12
- Module – main components 16
- Module – electrical components 17
- Frame & sash 18
- Cladding & flashing 22
- Glazing unit 24
- Brackets & hinges 28
- Module – assembled 30
- Sub-construction 32
- Vapour barrier connection strip / Products for swimming pool environments 34
- Chain actuator 36
- Control system 37
- Roller blind 38
- Beam for Ridgelight at 5° 40
- Wind deflector for smoke ventilation modules 42
- Type sign 43

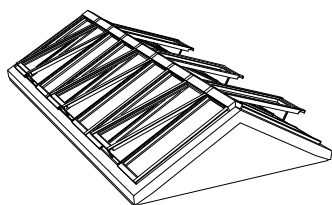

Solutions 45

- Quick overview of skylight solutions vs. roof constructions 46
- Longlight 5-30° 54
- Wall-mounted Longlight 5-45° 56
- Northlight 25-90° 58
- Ridgelight 25-40° 60
- Ridgelight at 5° with Beams (Horizontal beam with rectangular profile) 62
- Ridgelight at 5° with Beams (Parallel beam with curved profile) 64
- Step Longlight 5-25° 66
- Step Wall-mounted Longlight 5-25° 68
- Step Ridgelight 25° 70
- Step Ridgelight 5-25° on Girder 72
- Atrium Longlight 74
- Atrium Ridgelight & Atrium Ridgelight at 5° with Beams 76

Skylight Technical Data and Order-Code (see page 10) - EN 12200-2:2000			
Glazing unit	EN 12200-2:2000	A ₁ (17)	0.16 - 1.07 depending on size
Frame/sash unit	EN 12200-2:2000 Annex B	A ₁ (16/17)	0.05 - 0.09 depending on size
Cladding/flashing	EN 12200-2:2000 Annex B	C ₁ (2)	0.06 - 0.12 depending on size
Lower head (H ₁)	EN 12200-2:2000 Annex C	W ₁ (N ₁ 1)	750 N/m ²
Wind load (H ₂)	EN 12200-2:2000 Annex C	W ₂ (N ₂ 1)	5000 N/m ²
Low ambient temperature (T ₁)	EN 12200-2:2000 Annex C	R ₁ (2)	-1 (-10)
Windload (H ₂) - thermal capacity	EN 12200-2:2000 Annex C	R ₂ (N ₂ 1)	1000 - 3000
Resistance to heat (H ₂)	EN 12200-2:2000 Annex C	R ₁ (2)	0.030
Reaction to fire for H ₂ and H ₃	EN 12200-1	Class	B-s1, d0 Per 1000 (1, 2) and 4000 (H ₂ and H ₃)

Product Data 79

- Skylight module 80
- Glazing unit 98
- Frame & sash 101
- Cladding & flashing 101
- Interior colours frame & sash / Exterior colours cladding & flashing 102
- Vapour barrier connection strip 104
- Chain actuator 104
- Control system 106
- Roller blind 107
- Beam for Ridgelight at 5° 110
- Water pressure & drainage 111
- Resistance to wind load 112
- Reaction to fire 114
- Resistance to fire 116
- External fire performance 118
- Watertightness 120
- Air permeability 122

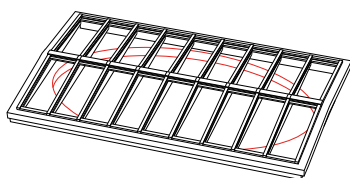

Additional Solutions 125

- Shaped solution with adaption of lining 126
- Shaped solution with oval lining 126
- Asymmetric Ridgelight 127
- Ridgelight on Girder 127
- Infill panel 128
- Skylight modules with photovoltaic glazing units 128
- Sun screening – electrochromic glass 129
- Sun screening – external awning blinds 129

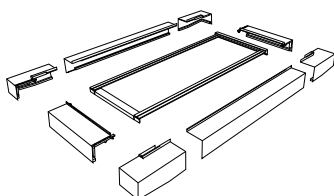

Product Codes 131

- Modular Skylight – code structure 132
- Roller blinds – code structure 133
- Product label – code structure 133
- Flashings – code structure 134

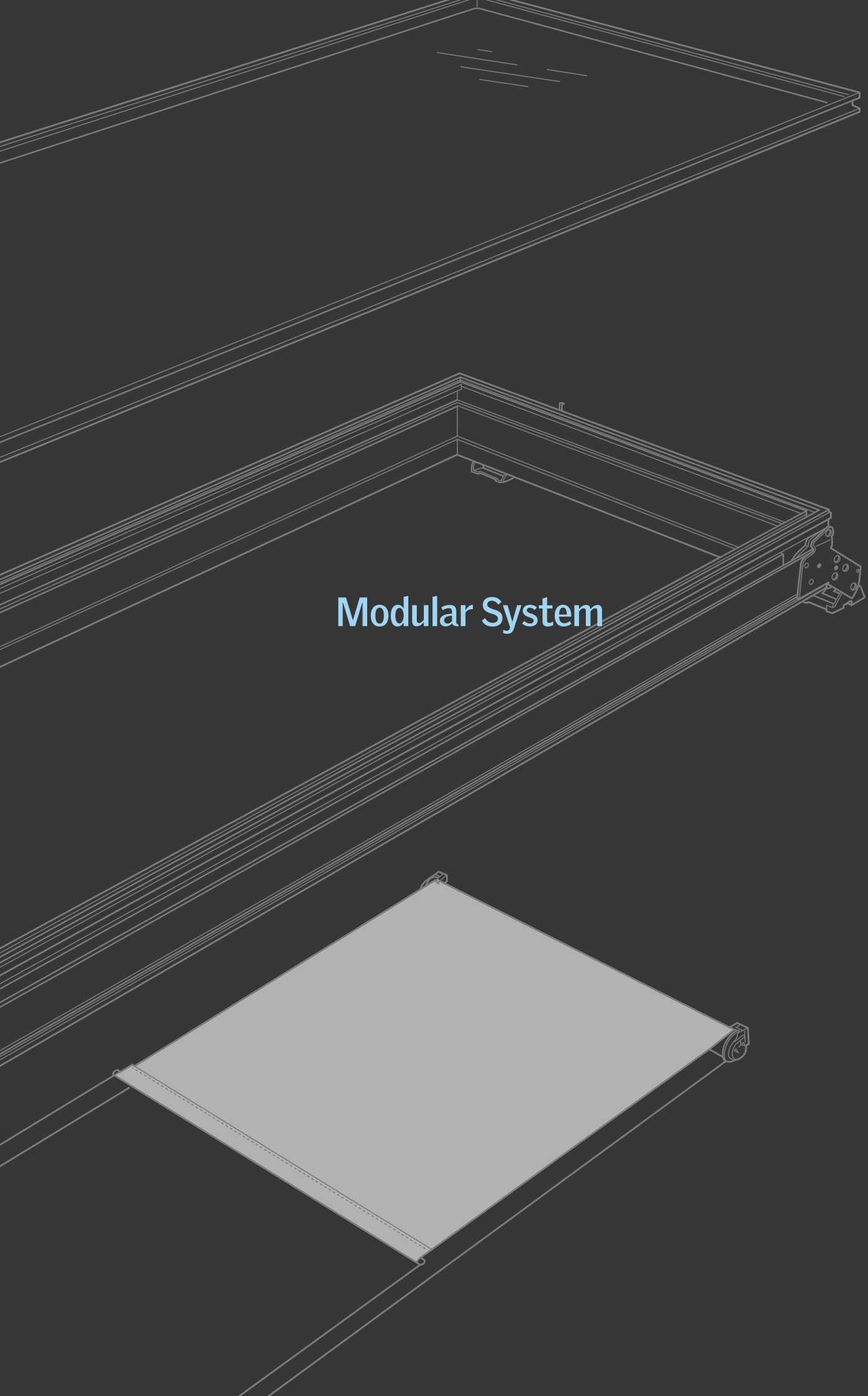

Modular System

Skylight module

CE-marked VELUX Modular Skylights can be used in any building where the national, local and individual building requirements allow the use of skylight modules. Given the aesthetics and advanced performance of the products, VELUX Modular Skylights are commonly used in heated buildings and primarily in projects that support light

commercial interests, e.g. hospitals, schools, shopping centres, offices, museums etc. However, all buildings that have a suitable structure and are large enough to host an installation, will support VELUX Modular Skylights.

Functions & sizes

VELUX Modular Skylights are available as fixed and venting modules. Due to a hidden chain actuator, the fixed and venting modules appear to be visually identical in closed position. It is not possible to install two venting modules next to each other.

Venting modules are top-hung and can be used for comfort ventilation, and in addition, certain types are approved for smoke ventilation in accordance with EN 12101-2.



HFC

Fixed skylight module.

HFS

Fire resistant module.



HVC-C

Motorized comfort venting skylight module.
Actuator chain stroke 260 mm.



HVC-A

Motorized smoke venting skylight module.
Actuator chain stroke up to 700 mm, which opens in less than 60 seconds.
Only open system actuator available.

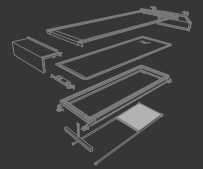

Size grid

Standard size.

Semi-Standard, functional limitations may apply.

Non-Standard, available for certain projects.

Fixed modules

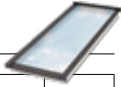

mm	675	750	800	900	1000
600	‡Δ	‡Δ	‡Δ	‡Δ	‡Δ
800	Φ	Φ	Φ	Φ	Φ
1000	Φ	Φ	Φ	Φ	Φ
1200					
1400					
1600					
1800					
2000					
2200					
2400					
2600	*	*	*	*	*
2800	*	*	*	*	*
3000	*	*	*	*	*

Comfort ventilation

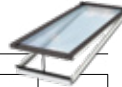

mm	675	750	800	900	1000
600					
800	Φ	Φ	Φ	Φ	Φ
1000	Φ	Φ	Φ	Φ	Φ
1200					
1400					
1600					
1800					
2000					
2200					
2400					
2600	* P	* P	* P	* P	* P
2800	* P	* P	* P	* P	* P
3000	* P	* P	* P	* P	* P

Smoke ventilation

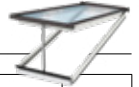

mm	675	750	800	900	1000
600					
800	○	○	○	○	○
1000	○	○	○	○	○
1200	○	○	○	○	○
1400	○	○	○	○	○
1600	○	○	○	○	○
1800	○	○	○	○	○
2000	○	○	○	○	○
2200	○	○	○	○	○
2400	○	○	○	○	○
2600	* ○ P	* ○ P			
2800	* ○ P				

- * Module height above 2400 mm is delivered with an extra strong glazing unit only.
- Δ No roller blinds available.
- Only open system actuator available.
- ‡ Not available for Ridgelight.
- P Not possible as start/end modules.
- Φ Roller blinds must be pre-mounted or installed by a VELUX technician.

For size specific load capacity, please contact us.
 If roller blinds are requested for smoke venting modules or fire resistant modules, please refer to local fire authorities for permission.
 NB: Roller blinds for smoke venting modules or fire resistant modules cannot be pre-mounted.
 Wind deflector KCD 0080 is not available for sizes above 2400 mm.

How to measure the module

Width and height of the modules are determined by the exterior dimensions of the frame – not the measurements of the cladding, flashing or brackets.



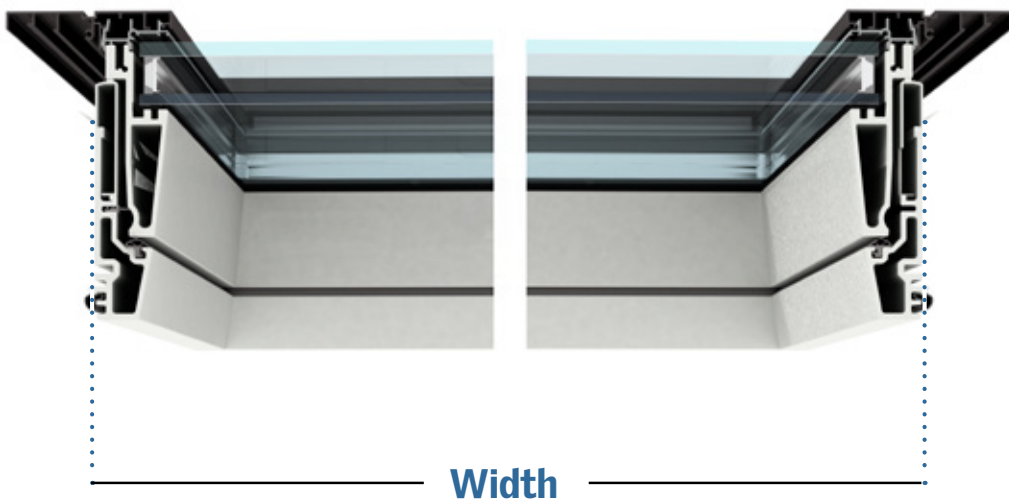
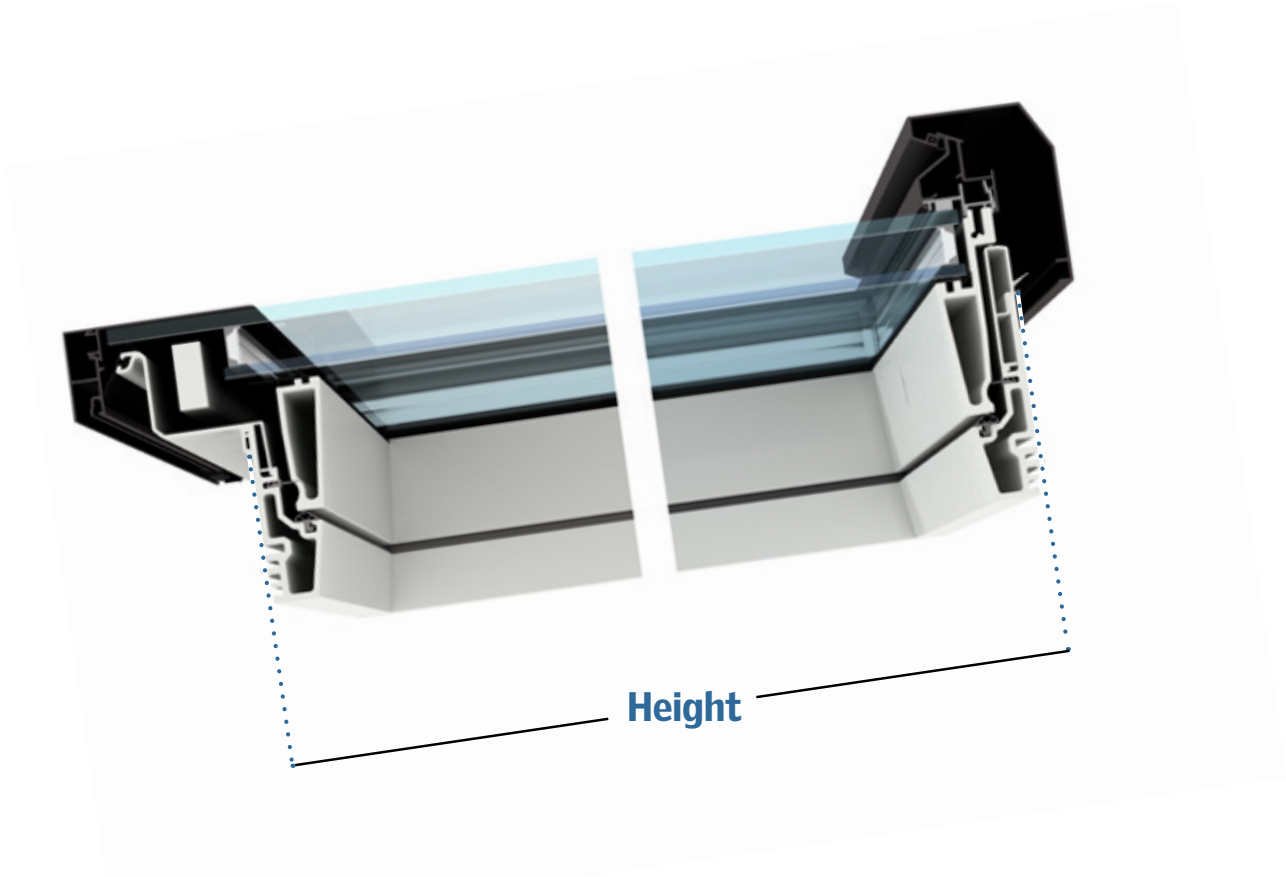
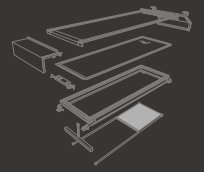

Solutions

VELUX Modular Skylights can be combined in a number of configurations to create perfect solutions for a wide variety of building types, from narrow corridors and internal courts to studios and

large circulation spaces. Each solution is delivered with a specially designed, prefabricated flashing ensuring a perfect system.

Mono pitched solutions

Longlight 5-30°

Page: 54

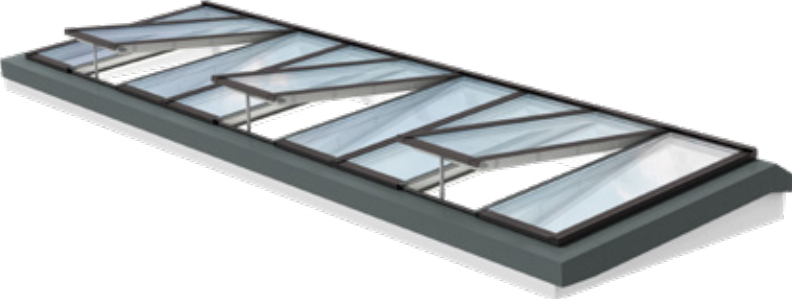

Wall-mounted Longlight 5-45°

Page: 56



Northlight 25-90°

Page: 58

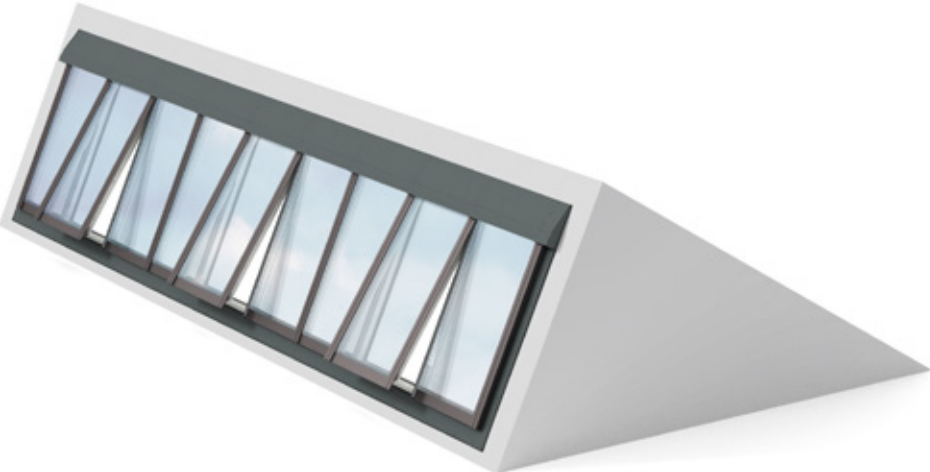

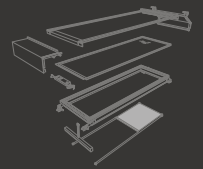

Dual pitched solutions

Ridgelight 25-40°

Page: 60

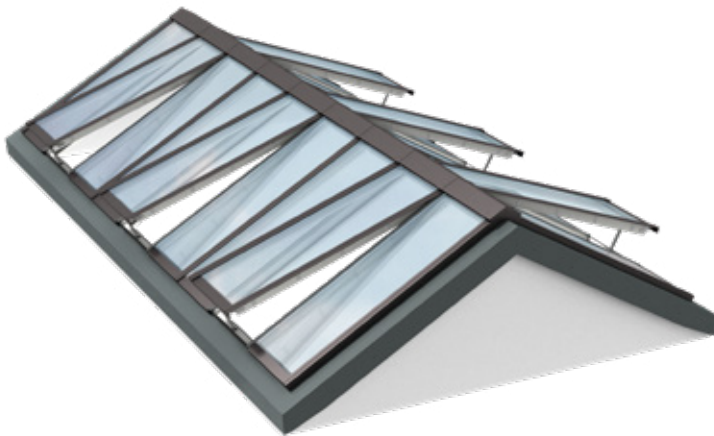

Ridgelight at 5° with Beams

Page: 62

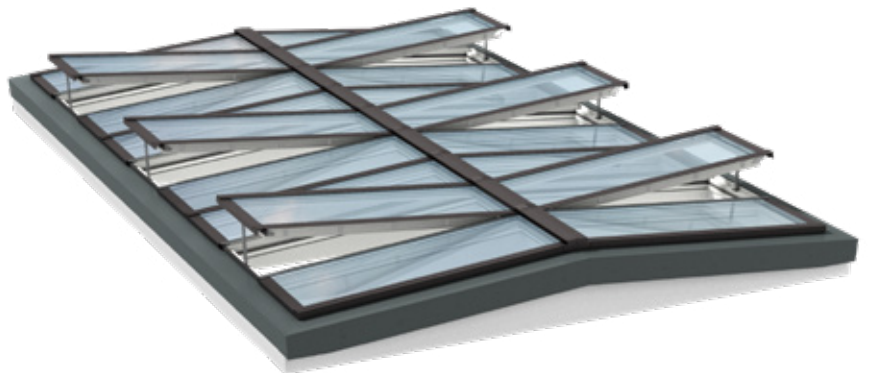



Step solutions

Step Longlight 5-25°

Page: **66**

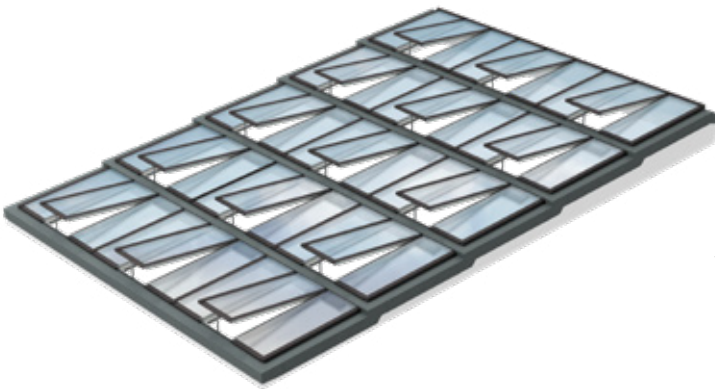

Step Wall-mounted Longlight 5-25°

Page: **68**

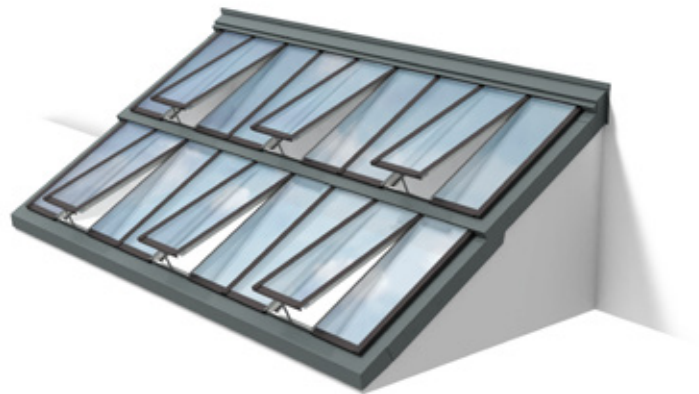

Step Ridgelight 25°

Page: **70**

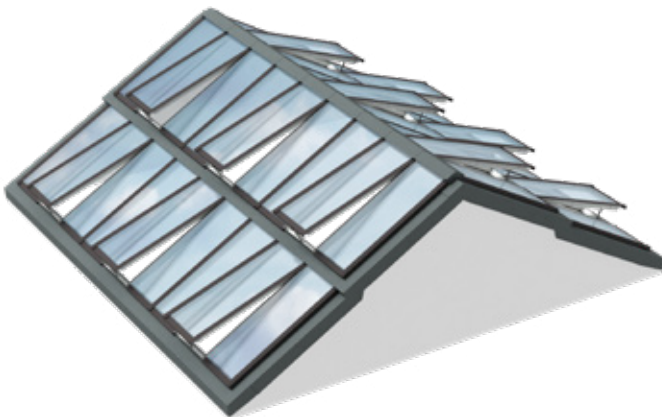

Step Ridgelight 5-25° on Girder

Page: **72**

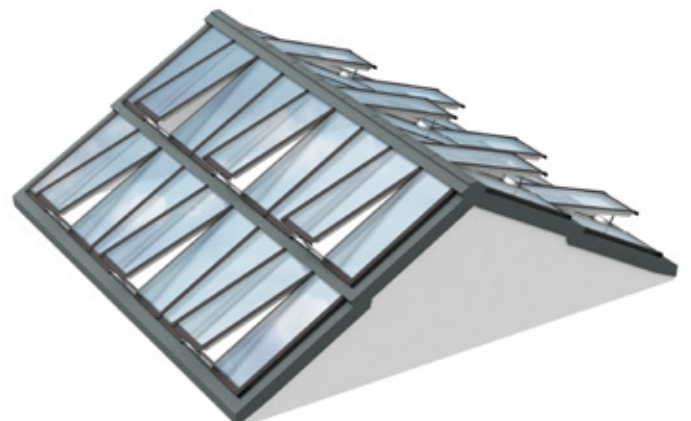

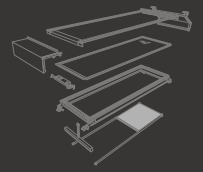

Atrium solutions

Atrium Longlight 5-30°

Page: 74



Atrium Ridgelight 25-40°

Page: 76



Atrium Ridgelight at 5° with Beams

Page: 76

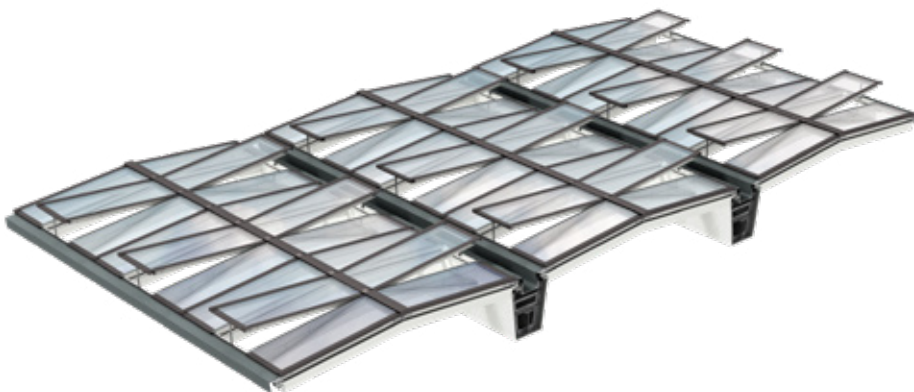

Module – main components

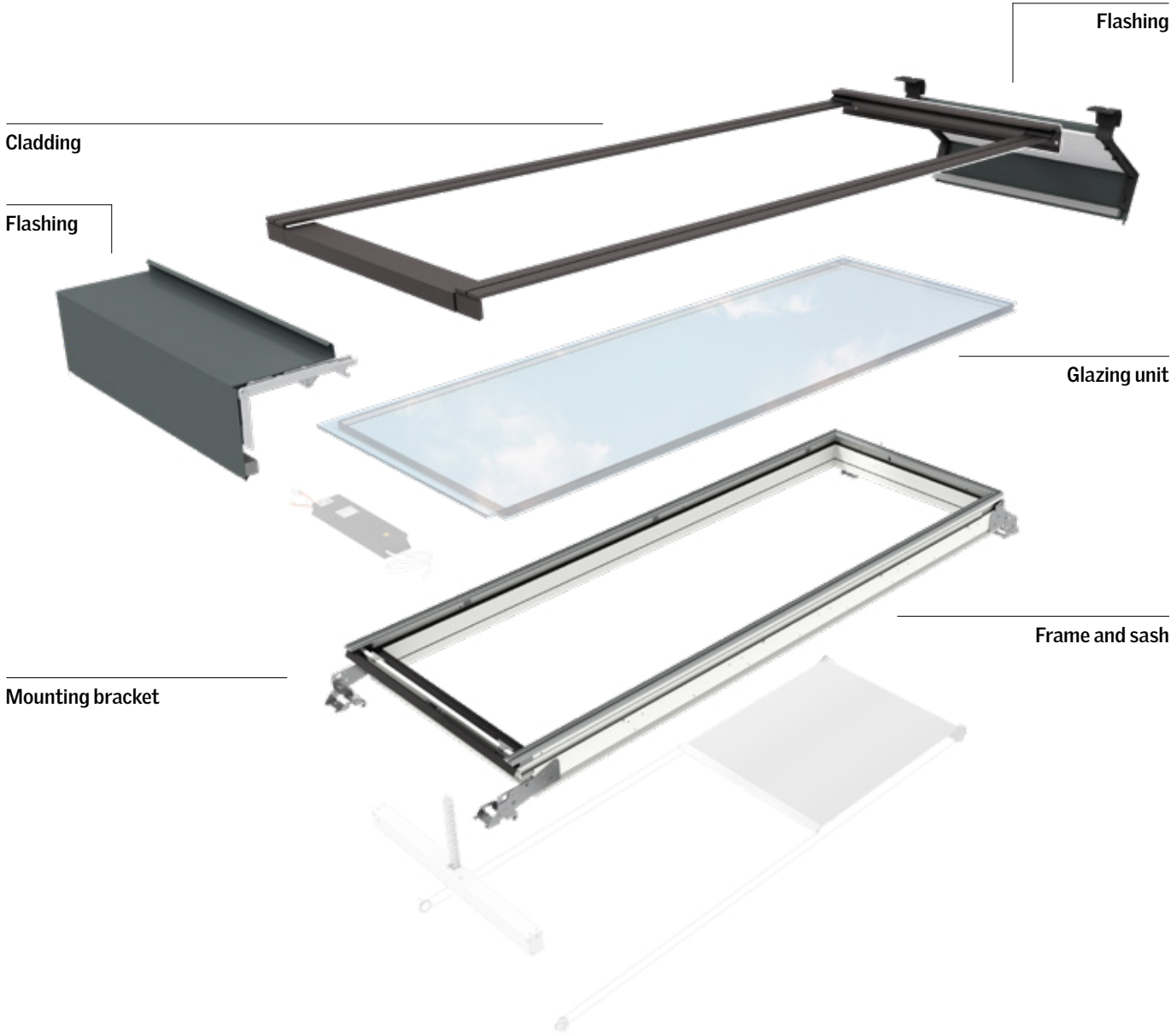

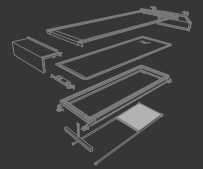

Module – electrical components

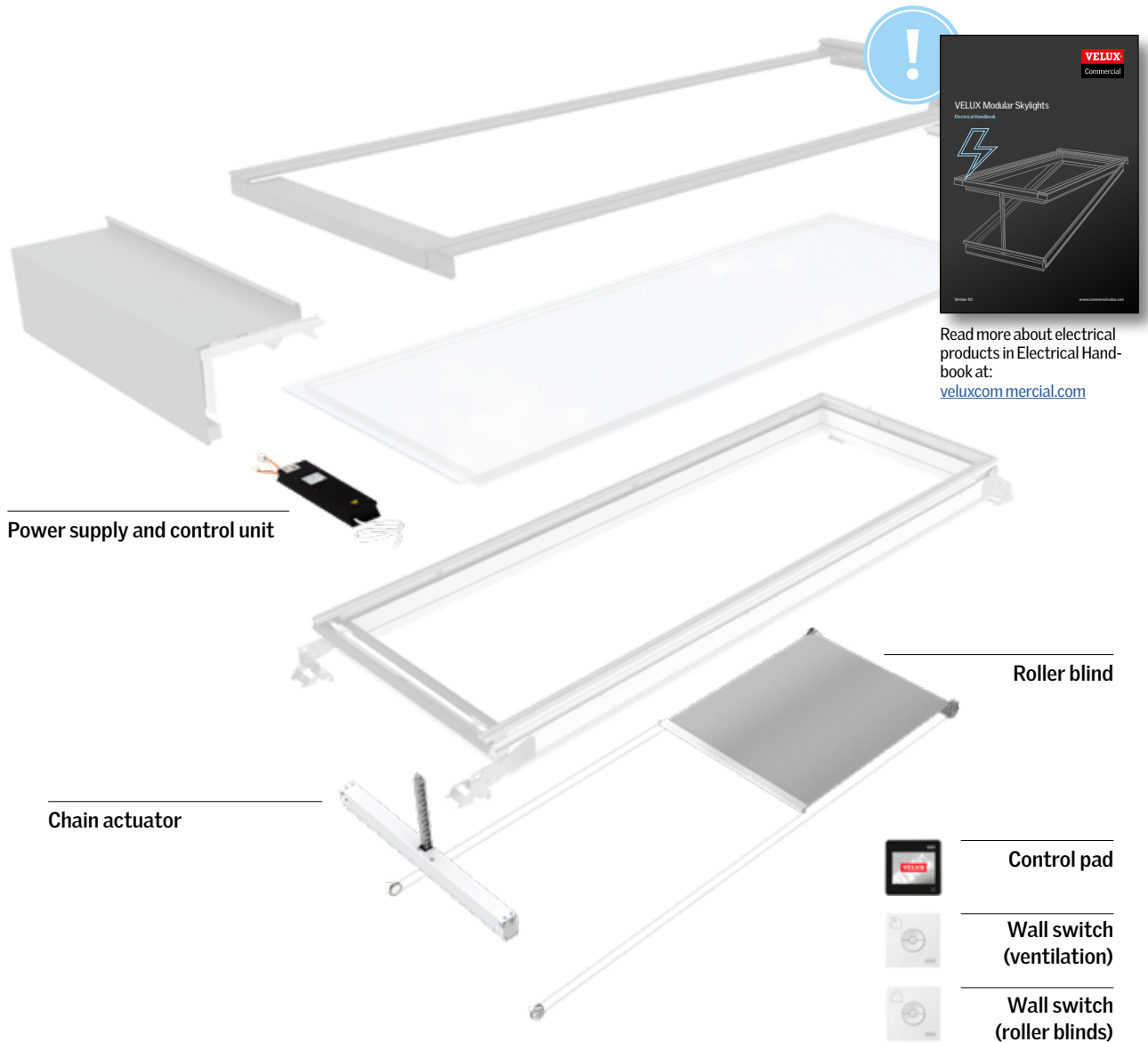

Power supply and control unit	Rain sensor	Rain and wind sensor set	Control pad	Wall switch	Switch interface (external wall switch)	Interface (external controls)
				 For ventilation For roller blinds		
KLC 410	KLA 200	KLA S105	KLR 200	KLI 311/KLI 312	KLF 050	KLF 200

Frame & sash

The main structural profiles of VELUX Modular Skylights consist of pultruded composite, containing approximately 80% continuous fibreglass threads and 20% two-component polyurethane resin.

The composite guarantees a high heat insulating performance (page 20, graph 1) and thermal stability (page 20, graph 2), as well as, excellent profile stiffness (page 21, graph 3) and strength (page 21, graph 4). Combined, the characteristics of the VELUX composite give the slim profiles self-supporting strength and an ability to

support installations of considerable size. In addition, the material is maintenance-free, non-corrosive and electrically non-conductive.

Combined with low-energy glazing units, VELUX Modular Skylights have one of the lowest overall U-values for frame and glazing assemblies on the skylight market. The inner surface is treated with white paint as standard. However, other colours are available, see page 102.



Frame and sash assembled

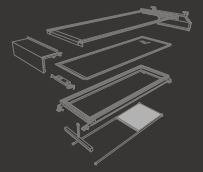

Frame & sash

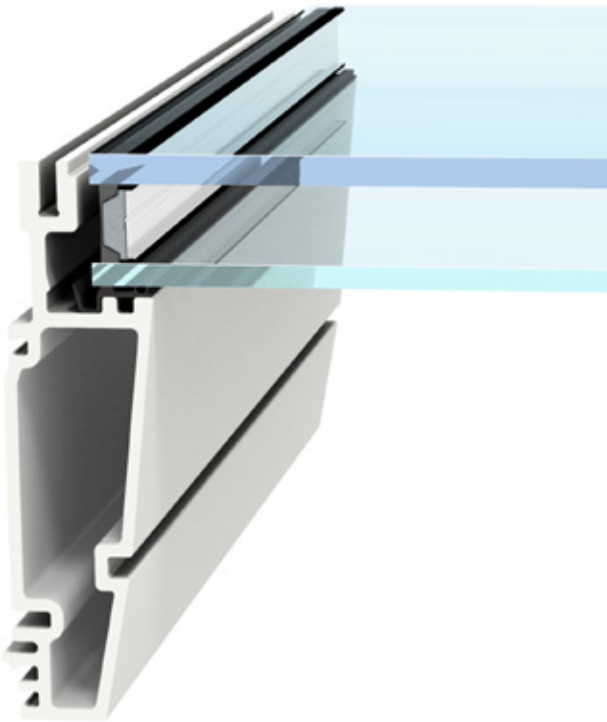

HFC

Frame for fixed skylight module

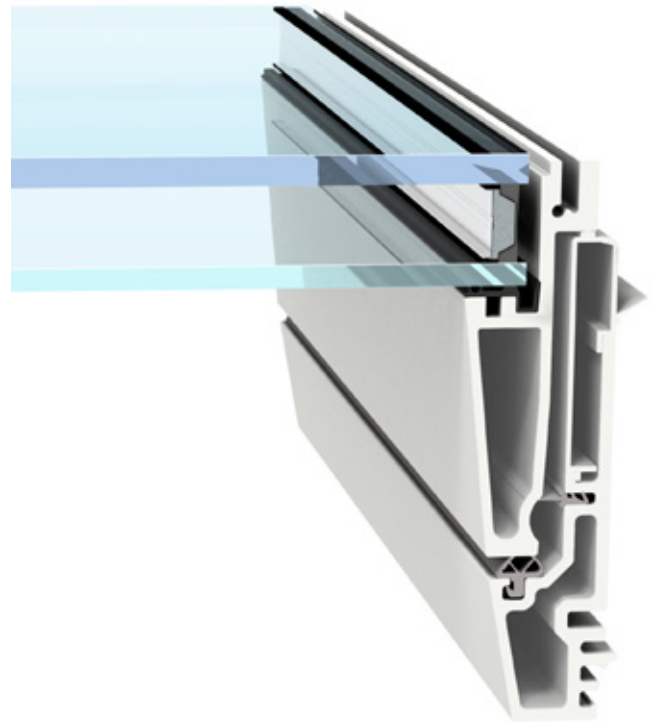

HVC

Frame and sash for venting skylight module

Frame & sash

1 Thermal conductivity (W/mK)

- A low score means high insulating performance

Profiles used for VELUX Modular Skylights consist of pultruded fibreglass and polyurethane composite, which result in a high insulating performance.

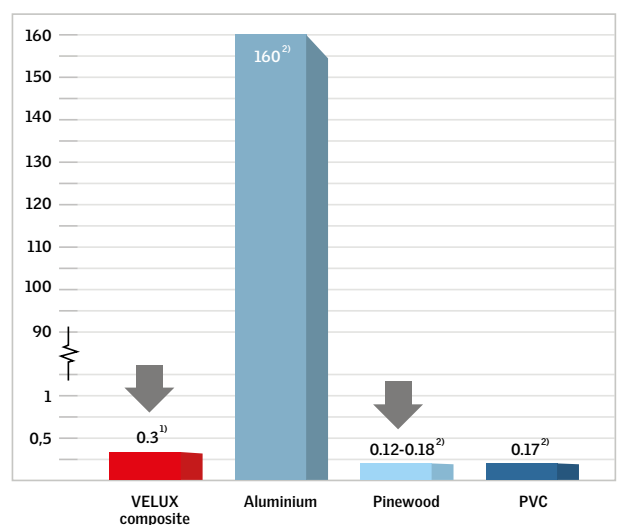

2 Linear expansion coefficient (10⁻⁶ m/mK)

- A low score means high thermal stability

Whereas traditional skylight materials are bound to fluctuations in form due to thermal changes, the composite of VELUX Modular Skylights will maintain its dimensional properties, ensuring tightness of joints and prolonging the expected lifetime of the application.

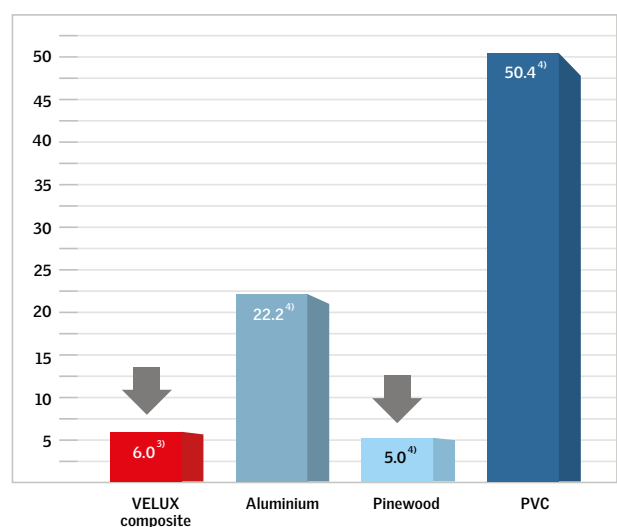

Source: ¹⁾ Accredited external tests ²⁾ According to EN ISO 10077-2 ³⁾ Value identical to fibreglass ⁴⁾ www.engineeringtoolbox.com ⁵⁾ Internal VELUX test

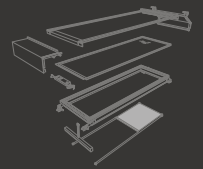

Frame & sash

3 Flexural modulus (E-Modulus) (GPa)

- A high score means low deflection

The high rigidity of the pultruded composite material results in a very stiff frame and sash, ensuring reliable performance with very little deflection of the profiles and better aesthetics of the skylight.

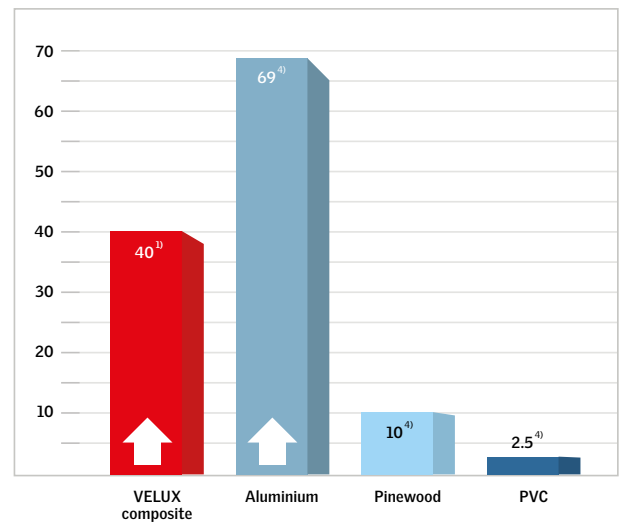

4 Flexural strength (N/mm²)

- A high score means high strength

The very high strength of the pultruded composite material allows for design and production of longer and slimmer frame and sash profiles than traditional skylight materials allow. This enables design of large skylights with slim profiles resulting in better aesthetic performance.

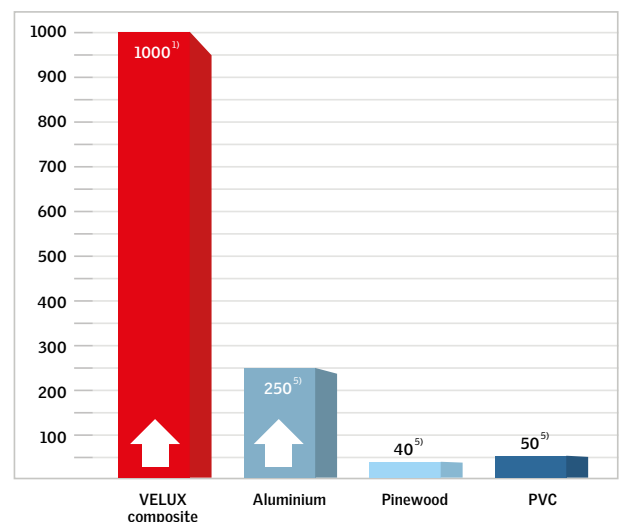

Source: ¹⁾ Accredited external tests ²⁾ According to EN ISO 10077-2 ³⁾ Value identical to fibreglass ⁴⁾ www.engineeringtoolbox.com ⁵⁾ Internal VELUX test

Cladding

Cladding

Each module has a specific set of claddings. Cladding components are attached on four sides of the skylight, ensuring a watertight connection between sash and frame for both fixed and venting

modules. The cladding is made of extruded aluminium with a scratch resistant, granite grey powder coating for added weather protection and aesthetics. Other colours are available, see page 103.



Flashing

Flashing

VELUX Modular Skylights come with factory-finished flashings. The prefabrication of flashings ensures a high quality solution providing a watertight connection between roof, sub-construction and module, with a safe and fast installation process.

The flashing has a top, side and bottom section made from aluminium with a grey paint finish.

Other colours are available, see page 103.

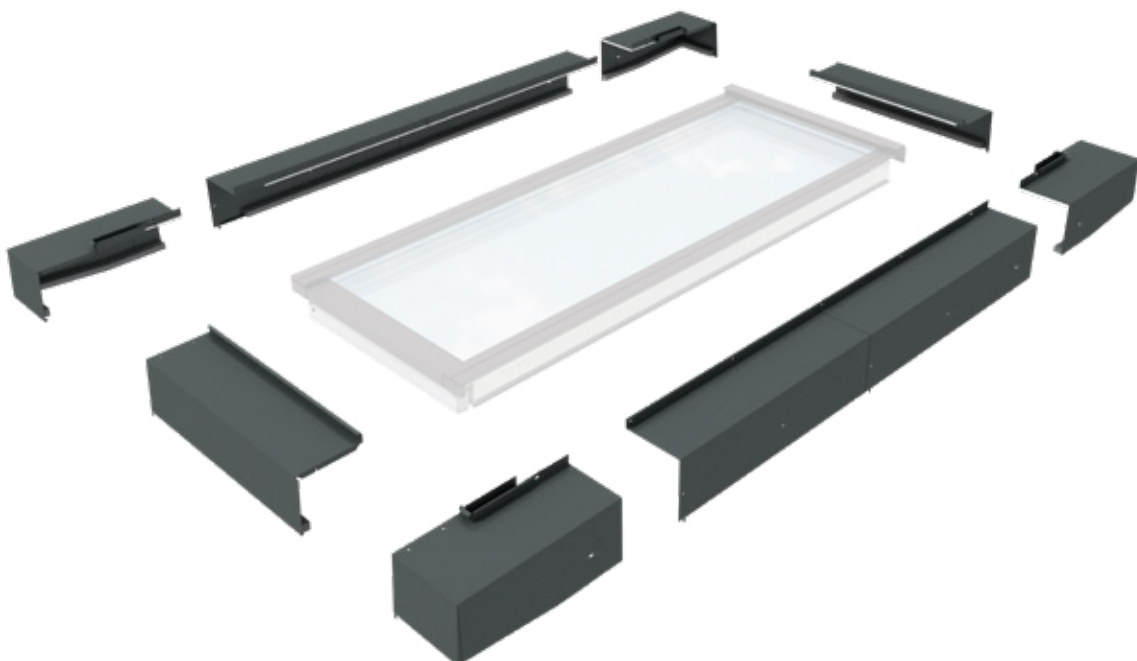

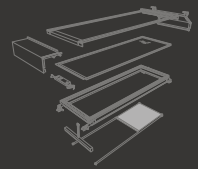

Flashing

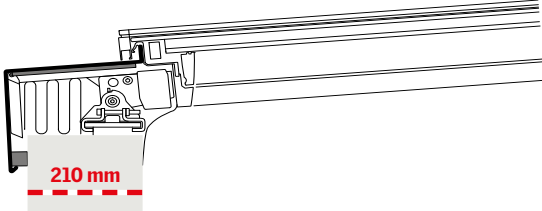
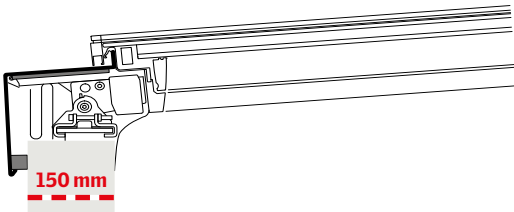
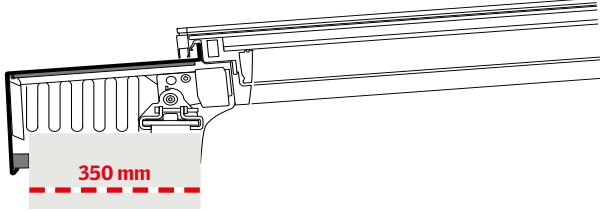
Standard flashing	Cross-section of the bottom flashing
<p>Standard flashing</p> <p>Standard top, bottom and side flashing suitable for a 210 mm sub-construction (measured from inside edge of the steel). See page 32.</p>	
Semi-standard flashing	Cross-section of the bottom flashing
<p>Narrow flashing</p> <p>Narrow top, bottom and side flashing that is suitable for a 150 mm wide sub-construction.</p> <p>Available at additional cost.</p> <p>Can be used for instance, if the extra slim sub-construction is required.</p>	
<p>Wide flashing</p> <p>Wide top, bottom and side flashing that is suitable for a 350 mm wide sub-construction.</p> <p>Available at additional cost.</p> <p>Can be used for instance, if the sub-construction is made of concrete and space for insulation is needed.</p>	

Glazing unit

VELUX Modular Skylights come with a low-energy double-glazing unit. Alternatively, the modules can be supplied with improved solar protection or an Argon or a Krypton filled triple-glazing unit for extra-low U-value. All glazing units include a toughened outer glass layer and a 3+3 or 5+5 mm inner safety glass layer with 2 x 0.38 mm interlayer PVB foil. For technical values on glazing units, please refer to the chapter about Product Data.

The triple-glazed units have a heat strengthened middle glass layer. For triple-glazed variants with a 5+5 mm inner pane, heat strengthened glass is used.

The cavity between the panes of the glazing units is filled with Argon or Krypton gas as a default.

All glazing units have a warm edge spacer and are produced with warm edge technology to minimise the risk of condensation and to give the glazing units the most durable insulation capabilities.



Glazing unit

Example of double-glazed unit (LowE)

Variant 10L

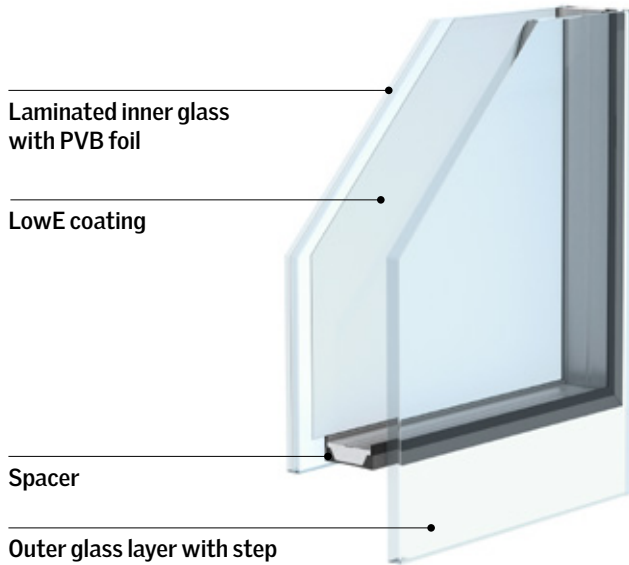

Example of triple-glazed unit (LowE)

Variant 16L

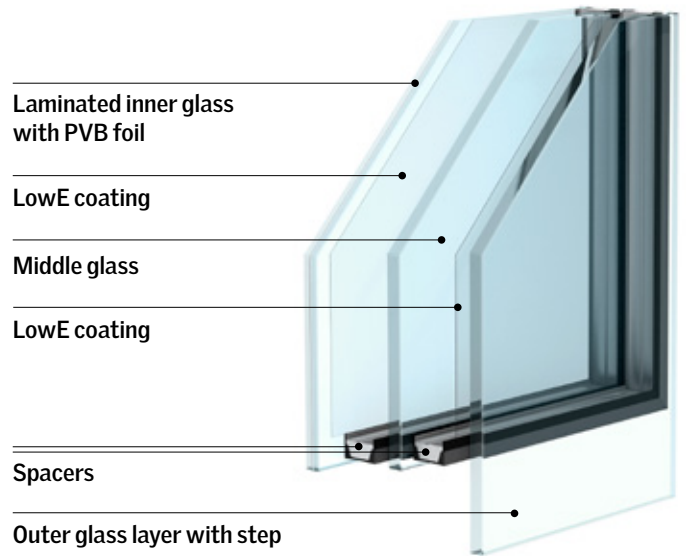

Note: Visual quality of glazing units. Interference effects and/or effects specific to multiple glazing and/or anisotropy may occur in the visible glass surface due to the physics of the material and its production technologies.

Differentiating parameters of the coating variants

Coating options		Coating	Solar gain	Solar protection	Light transmittance	Colour rendering index
Low emissivity	When the highest light transmittance is needed and you would like to let in the heat from the sun during heating season.	LowE	☆☆☆	☆	☆☆☆	☆☆☆
Sun protection	When sun protection is required to keep out the heat from the sun for increased comfort during summer periods.	Sun1	☆☆	☆☆	☆☆	☆☆
Enhanced sun protection	When extra sun protection is required for increased comfort during summer periods and a reduced light transmittance can be accepted.	Sun2	☆	☆☆☆	☆	☆

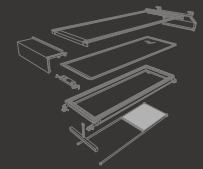

Glazing unit

Colour renderings of double-glazed units

Additional glazing characteristics and glazing variants are shown on pages 98-100.
All mentioned values are in accordance with EN 410.

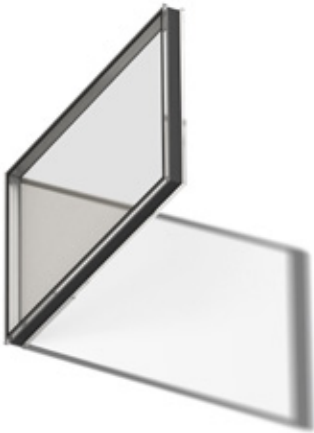

Glazing with low emissivity coating (LowE)

Variant 10L

Light transmittance: τ_v -value = 80%
Solar factor: g-value = 62%
Colour rendering index: R_a = 96

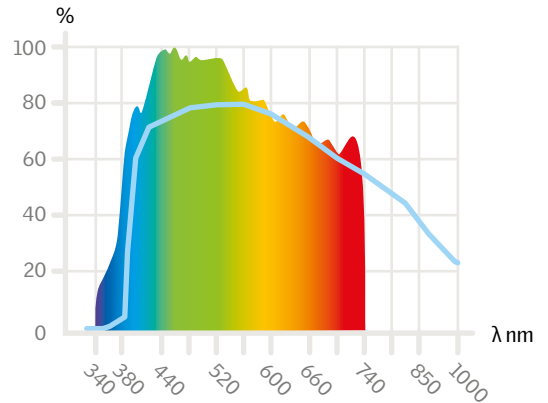

Glazing with light sun protection coating (Sun1)

Variant 11L

Light transmittance: τ_v -value = 50%
Solar factor: g-value = 27%
Colour rendering index: R_a = 91

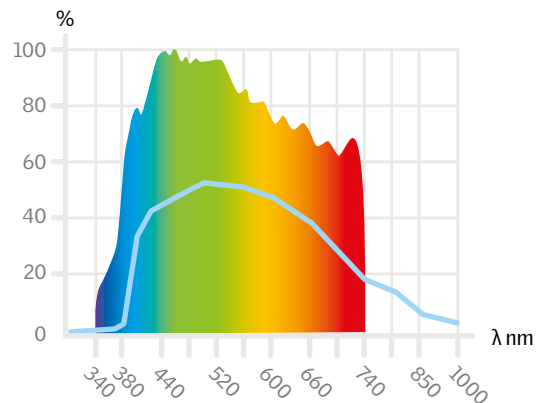

Glazing with enhanced sun protection coating (Sun2)

Variant 12T

Light transmittance: τ_v -value = 18%
Solar factor: g-value = 17%
Colour rendering index: R_a = 91

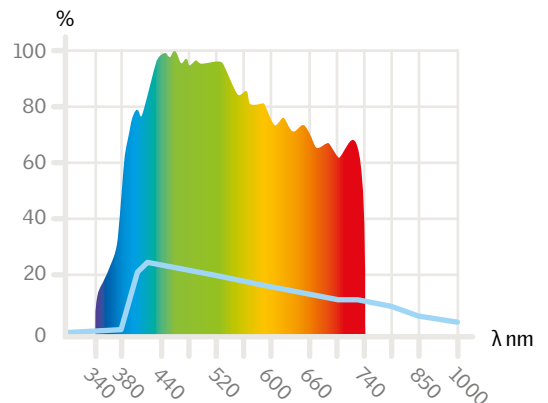

Spectral values (wave length in nm)

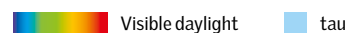

Glazing unit with low emissivity coating and roller blind RMM

Colour renderings of double-glazed units

Additional glazing characteristics and glazing variants with roller blind are shown on pages 108 and 109. All mentioned values are in accordance with EN 410.



Glazing with low emissivity coating (LowE) and Roller Blind RMM 8806, White

Variant 10L

Light transmittance: τ_v -value = 30%
 Solar factor: g-value = 34%
 Colour rendering index: R_a = -

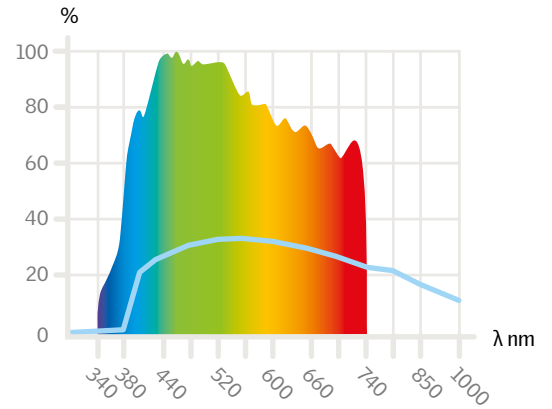

Glazing with low emissivity coating (LowE) and Roller Blind RMM 8805, Grey

Variant 10L

Light transmittance: τ_v -value = 8%
 Solar factor: g-value = 41%
 Colour rendering index: R_a = -

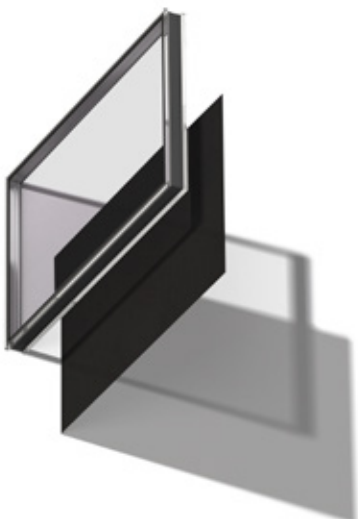
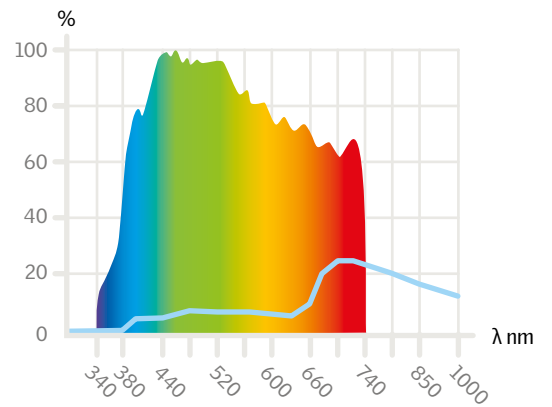



Glazing with low emissivity coating (LowE) and Roller Blind RMM 8807, Black

Variant 10L

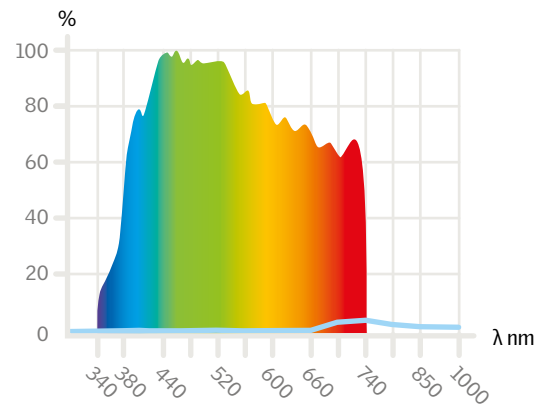
Light transmittance: τ_v -value = 1%
 Solar factor: g-value = 35%
 Colour rendering index: R_a = -



Spectral values (wave length in nm)
 Visible daylight  tau

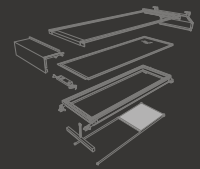

Glazing unit with fritted or opal surface

Colour renderings of double-glazed units

Additional glazing characteristics and glazing variants are shown on pages 98-100.
All mentioned values are in accordance with EN 410.



Glazing with low emissivity coating (LowE)

Variant 10L

Light transmittance: τ_v -value = 80%
Solar factor: g-value = 62%
Colour rendering index: R_a = 96

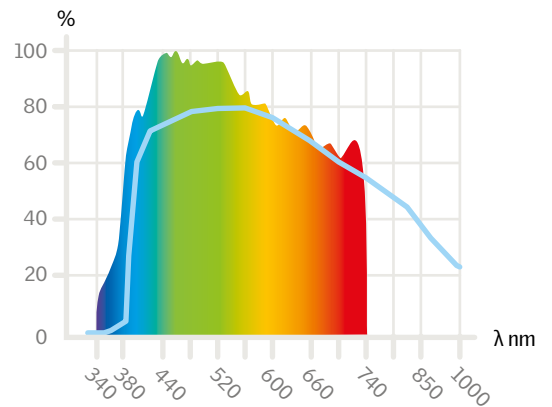

Glazing with low emissivity coating (LowE) and opal surface*

Variant 10 + opal

Light transmittance: τ_v -value = 46%
Solar factor: g-value = 56%
Colour rendering index: R_a = -

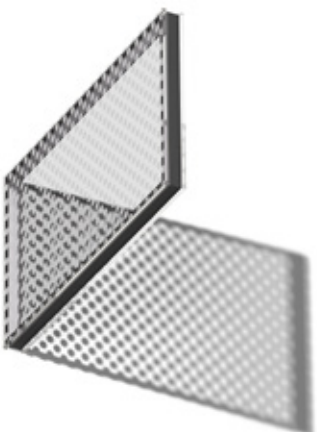
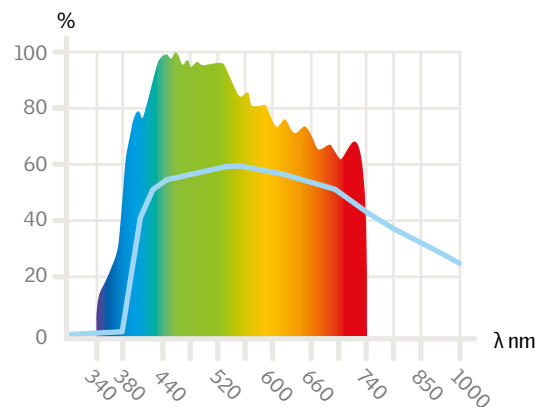

Glazing with low emissivity coating (LowE) and fritted surface*

Variant 10 + fritted

Light transmittance: τ_v -value = 53%
Solar factor: g-value = 40%
Colour rendering index: R_a = -

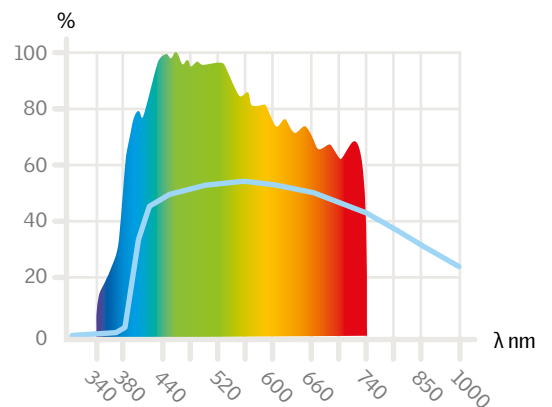

* Glazing with opal or fritted surface are semi-standard variants. The above values (with opal or fritted surface) are based on examples and depend on covering degree and pattern.

Brackets & hinges

Material and surface treatment

Metal components in VELUX Modular Skylights are made of galvanized steel.

The majority of the steel components are electroplated according to European norm EN ISO 2081 table A1 – C: iridescent. Components fulfill corrosion resistance grade 4 in accordance with EN ISO 1670.

Based on these properties, VELUX Modular Skylights can be used where external weather conditions and indoor climate conditions are within the normal spectre of corrosiveness.

Note: VELUX Modular Skylights standard solutions must NOT be used in indoor environments where the risk of condensation on metal components can lead to extreme corrosive attacks. These environments include facilities that use highly corrosive substances, e.g. salt and/or chloride. Evaporation can lead to corrosive attacks on components, weaken the functionality and in the end compromise the structural integrity of the installation. For use of VELUX Modular Skylights in buildings with swimming pools, specific swimming pool products are available, see page 35.

Brackets

VELUX Modular Skylights are supplied with mounting brackets and clamps and are ready to be installed on any preferred sub-construction made of steel, concrete or wood finished with a steel profile at the top. Mounting brackets are fixed during installation with a clamping system holding the skylight in place.

Using a steel profile on top of the sub-construction is an advantage, as the clamps at any time during installation can be released to allow minor positional adjustment of the modules.

If the customer chooses not to use the mounting clamps, but to screw the mounting brackets directly into the wooden batten, please note that the screws are not included in the VELUX delivery, and therefore delivery and correct dimensioning must be ensured by the customer.

Hinges

The pre-fitted hinges of the venting modules are tested under the most severe conditions, by continuously opening and closing the largest and heaviest modules.



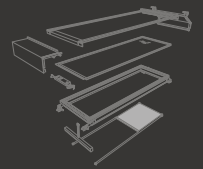

Examples of brackets & hinges



Top bracket for Longlight 5-30°

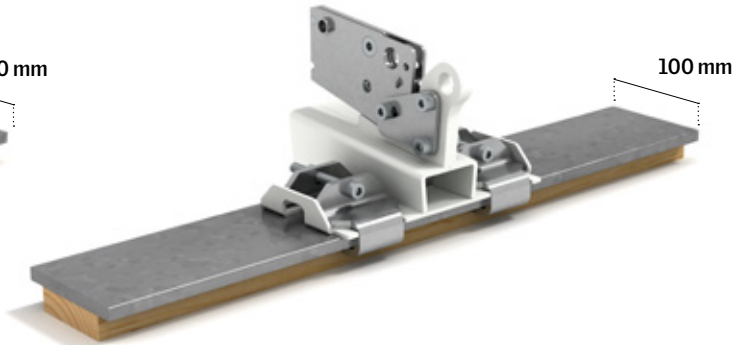

Bottom bracket for Ridgelight at 5° with Beams.
Parallel beam with curved profile.



Bottom bracket for Longlight 5-30° and Ridgelight 25-40°

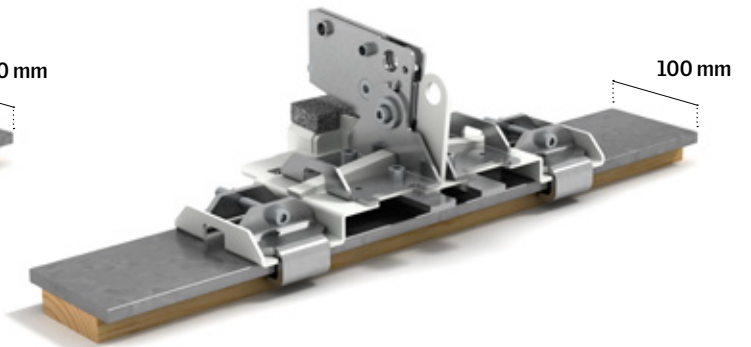

Bottom bracket for Ridgelight at 5° with Beams.
Horizontal beam with rectangular profile.



Top bracket for Northlight 25-90°



Top bracket for Wall-mounted Longlight 5-45°



Top bracket for Ridgelight at 5° with Beams



Top bracket for Ridgelight 25-40°



Clamp for fixing mounting
bracket on steel profile

Module – assembled

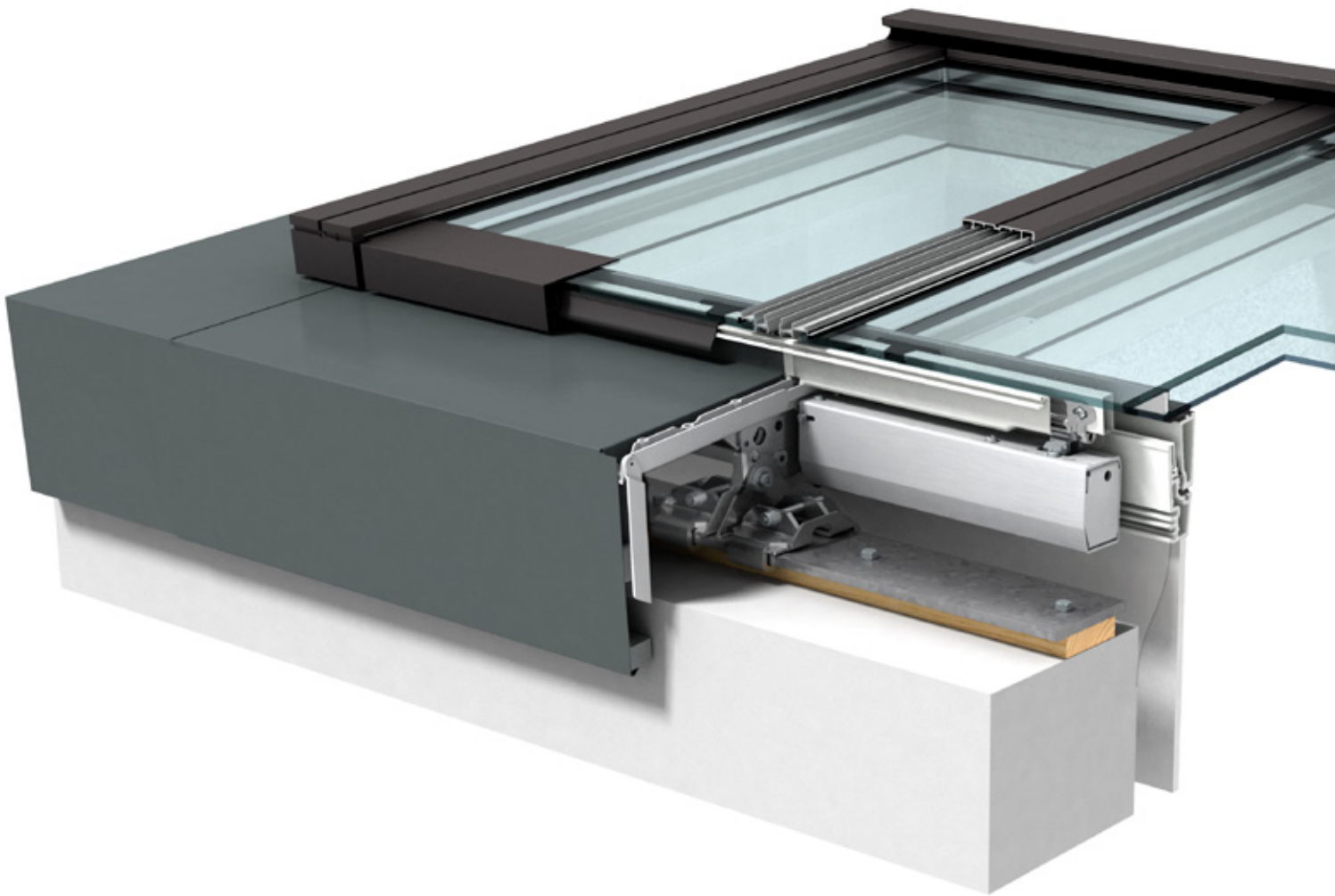

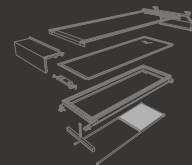

Sub-construction

Easy installation process

VELUX Modular Skylights require an accurate, fixed and dimensioned sub-construction. The strength of the sub-construction must also be calculated for the individual project, based on the building design and application size. It is the responsibility of the customer to have a static calculation of the sub-construction done by a static engineer.

In this way, the sub-construction is not a part of the prefabricated modular skylight system. The VELUX Group is not responsible for the sub-construction.

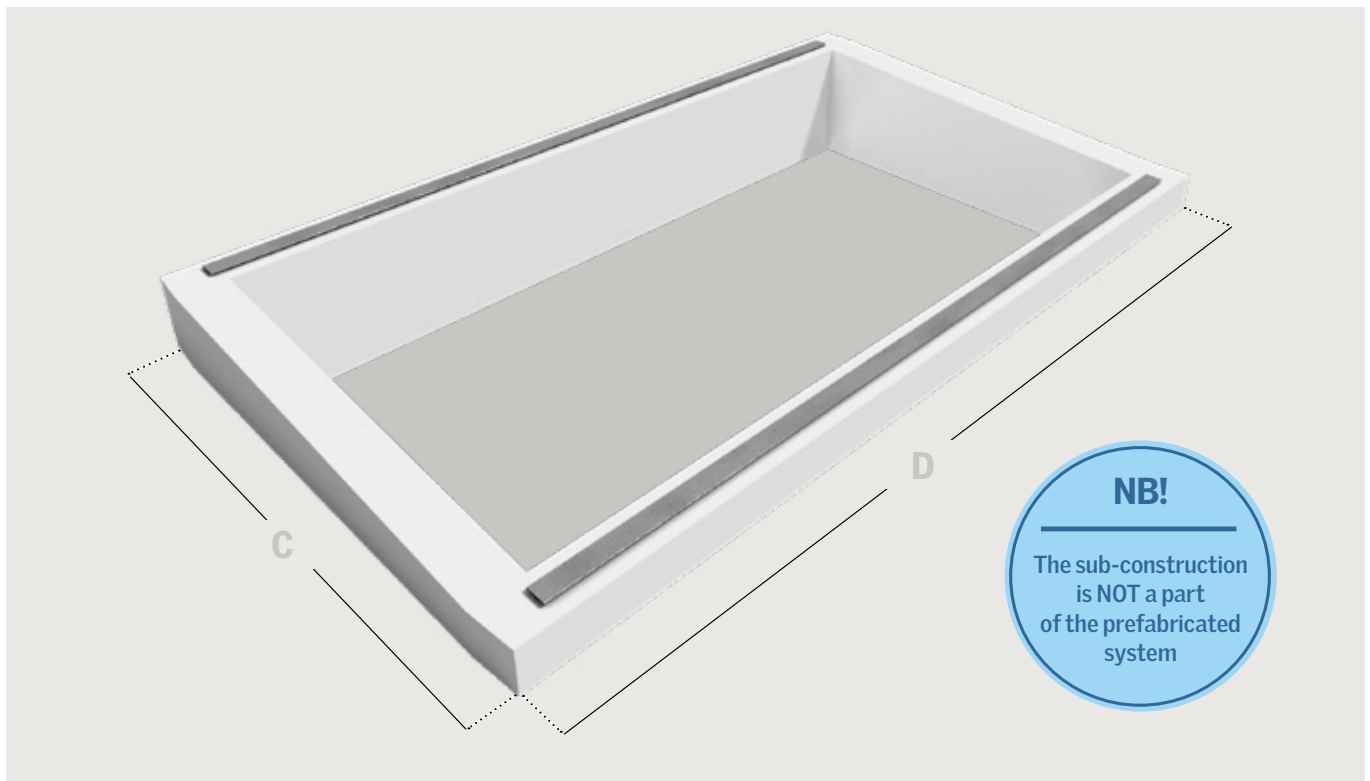

Wood sub-construction finished with a steel profile at the top



Wood is the most flexible choice for creating a light and economical sub-construction with maximum energy performance. However, it is not recommended for larger solutions and Ridgelight installations.

Steel sub-construction finished with a steel profile at the top

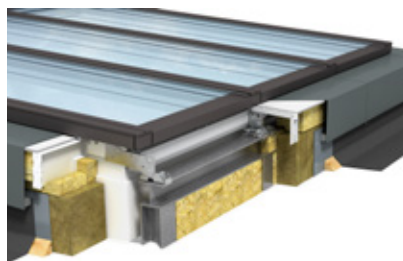

Steel offers flexibility in combination with great strength. Steel also allows a maximum amount of insulation to be used in the installation.

Concrete sub-construction finished with a steel profile at the top

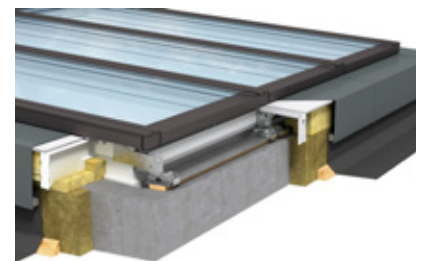

Concrete provides a strong, but heavy sub-construction and is mostly suited for concrete buildings. Concrete sub-constructions are usually cast on site.

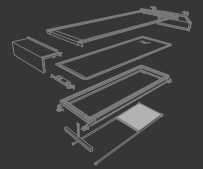

The steel profile

A steel profile is the most important link when mounting the modules to the sub-construction. Please observe that the steel profile should cover the full opening length to allow minor

positional adjustment of the modules during installation. Please also observe that the top and bottom sub-construction and therefore also the steel profile must be horizontal.



Steel profile on timber

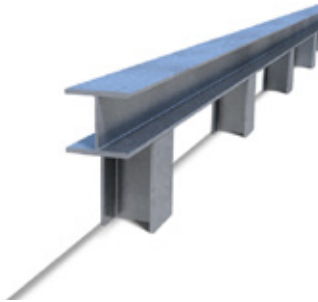

Steel profile on steel

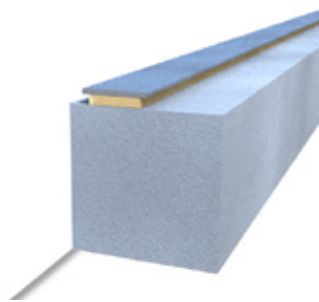

Steel profile on concrete

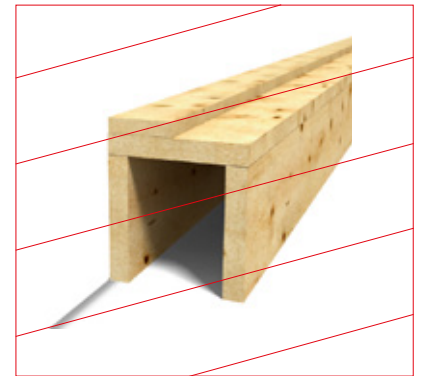

Wood profile on timber is not recommended by VELUX Commercial.

Download material and recommendations on sub-construction



See our large selections of material on Longlight, Wall-mounted Longlight, Northlight, Ridgelight, Ridgelight at 5° with Beams, Step, Longlight, Step Ridgelight, Step Ridgelight on Girder, Atrium Longlight, Atrium Ridgelight and Atrium Ridgelight at 5° with Beams

Read all about sub-constructions in the guides at: veluxcommercial.com

Vapour barrier connection strip

To ensure a high quality installation of VELUX Modular Skylights and to prevent condensation occurring within the sub-construction, it is highly recommended to install BCX vapour barrier connection strip.

The factory-finished BCX creates the perfect connection between the VELUX Modular Skylights and the vapour barrier of the building. BCX is CE-marked in accordance with EN 13984.

The vapour barrier connection strip BCX is made of a diffusion-tight polyethylene foil completed with a pre-fitted rubber gasket along one edge. With a perfect fit into the skylight frame rebate, installation is an easy job that guarantees a vapour-tight solution.

Vapour Barrier Connection Strip
(Factory-finished)

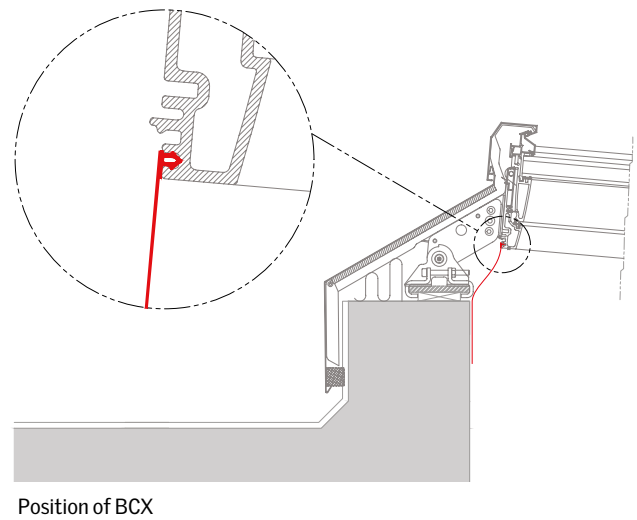

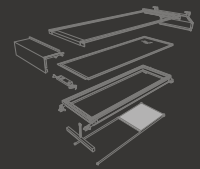

Products for swimming pool environments

When using VELUX Modular Skylights in environments like swimming pools with high levels of humidity, salt or chloride, it is crucial to ensure a vapour tight installation to prevent condensation of highly corrosive substances like salt and/or chloride that can lead to corrosive attacks on metal components.

VELUX specially designed vapour barrier connection strip, vapour barrier adhesive and inner ridge cover must be used in environments with swimming pools. Please observe any national requirements in swimming pool areas.

Vapour barrier connection strip for swimming pools

The factory-finished vapour barrier connection strip BSX developed especially for use in swimming pool environments creates the perfect connection between the VELUX Modular Skylights and the vapour barrier of the building. BSX is CE-marked in accordance with EN 13984.

BSX is made of a multilayer foil including aluminium with a very high water vapour resistance completed with a pre-fitted rubber gasket along one edge. Vapour barrier adhesive ZZZ 255 to be used together with vapour barrier connection strip.

NOTE:

Guarantee provided by VELUX for swimming pool projects is valid only when these dedicated swimming pool products are used correctly. Triple glazing is advised to minimise the risk of condensation. Roller blinds and Ridgelight at 5° with Beams are not compatible for use in swimming pool environments. For use of Northlight solutions, it is important that the roof construction is sufficiently ventilated close to the modules. Fire resistant module HFS is not compatible for use in Ridgelight solutions above swimming pools.

Inner ridge cover for swimming pools

For use of Ridgelight solutions above swimming pools, a specially designed inner ridge cover ZZZ 254 must be used. ZZZ 254 is made of 2 mm thick extruded white EPDM rubber. Please observe that due to material properties, there is a colour difference between ZZZ 254 and the white skylight frame. Vapour barrier adhesive ZZZ 255 to be used together with inner ridge cover.

Vapour barrier connection strip for swimming pools	Vapour barrier adhesive for swimming pools	Inner ridge cover for swimming pools
		
BSX	ZZZ 255	ZZZ 254

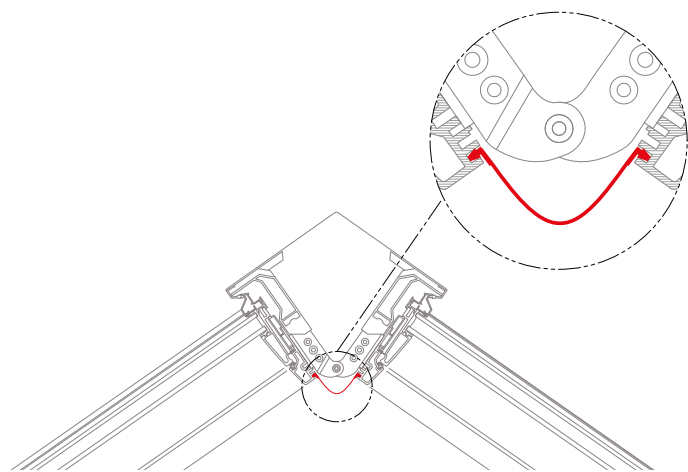
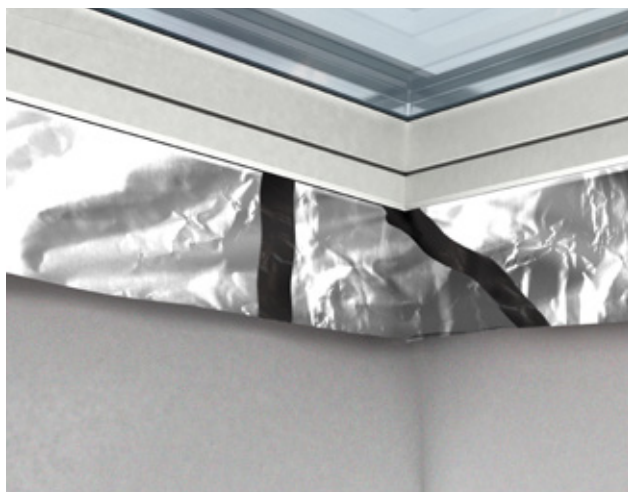

Position of ZZZ 254

Chain actuator

VELUX venting skylight modules are top-hung and have a hidden chain actuator integrated at the bottom profile.

For comfort ventilation there is one chain actuator variant which can be controlled with either VELUX INTEGRA® io-homecontrol technology and control pad KLR 200 for user friendly control or your preferred ± 24 V DC open system. The chain actuator for smoke ventilation can only be controlled by a ± 24 V DC open system.

The chain stroke on the open system actuator can be reprogrammed even after installation to suit specific needs.

The chain actuator is accessible from the roof. Therefore, maintenance requires no access from the inside of the building.

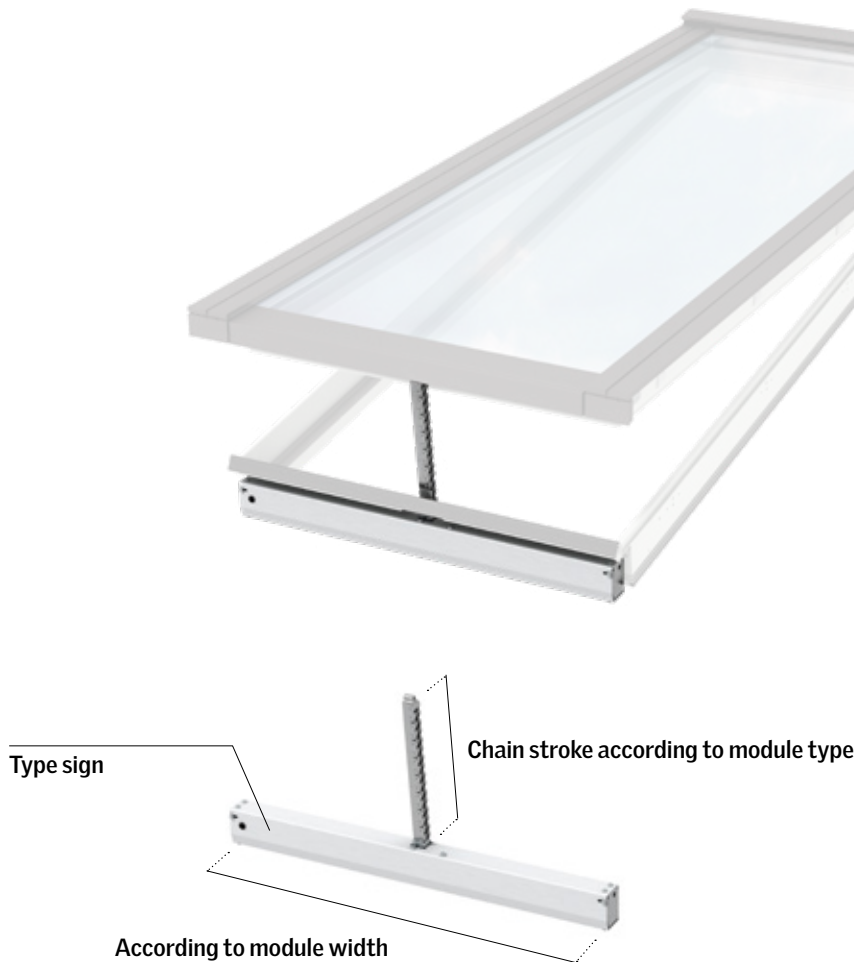

Comfort venting VELUX Modular Skylights meet the requirements of the harmonised standard EN 60335-2-103(2015) as to a max opening clearance of 200 mm (by means of physical limitation of the actuator) and as to the max closing speed of 15 mm/sec. Therefore, comfort venting skylights can be installed within reach, i.e. at installation heights below 2.5 m above floor level (inside) and ground level (outside). According to EN 60335-2-103 access levels are defined as e.g. stairs and terraces. Surfaces not normally used for standing on, such as windowsills, and movable equipment such as ladders, are not considered to be access level.

Please note that the venting skylights operate with high closing force, which can cause serious injury in case of entrapment. If VELUX roller blinds are installed in the skylight, please observe recommendations in the safety instructions provided with each VELUX roller blind RMM.

We recommend that you observe national regulations and consider if the planned specific use of the building requires additional safety measures that must be applied by the installer/user to prevent serious injury.

Smoke venting VELUX Modular Skylights and comfort venting VELUX Modular Skylights with a longer chain stroke than standard have a recommended minimum installation height of 2.5 m above floor level (inside) and ground level (outside). If they are installed below this level, safety measures must be applied by the installer/user to prevent serious injury. No instruction or measure can eliminate the inherent hazards resulting from installation heights below 2.5 m.

The VELUX Group will not accept responsibility for damages, injury or death resulting from such an installation. The installer/user is ultimately responsible for own omissions and actions. Measures could for instance be to install a motion sensor that is able to disconnect power from the control unit in case of any movement in the immediate vicinity of the VELUX Modular Skylights.

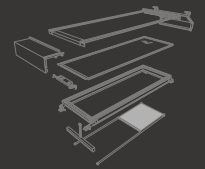

Control system

VELUX INTEGRA®

Venting modular skylights and roller blinds RMM can be powered and controlled from the VELUX INTEGRA® control unit KLC 410. Each KLC 410 can power and operate one venting skylight module and up to four roller blinds individually, in groups or simultaneously.

Skylights and blinds installed with the VELUX INTEGRA® KLC 410 control unit can be operated with the VELUX INTEGRA® wall switches KLI 311/312 or control pad KLR 200.

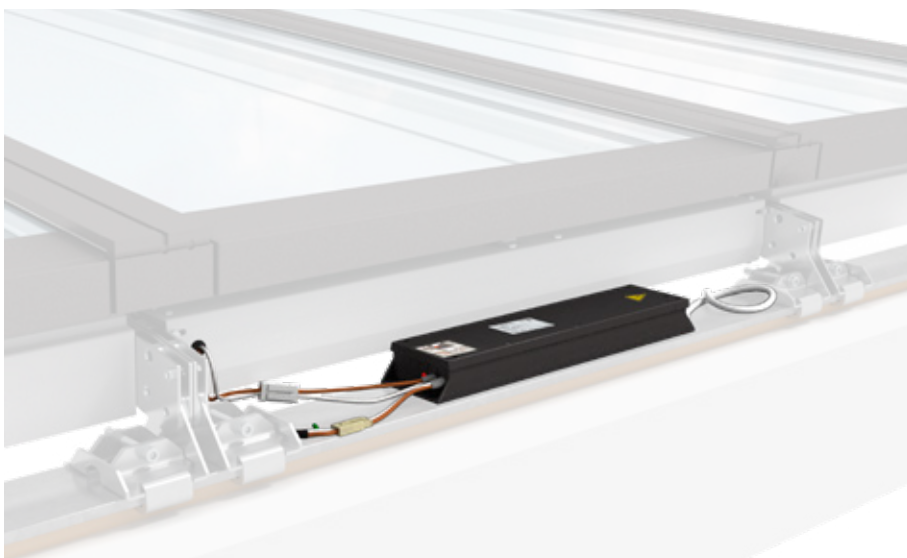
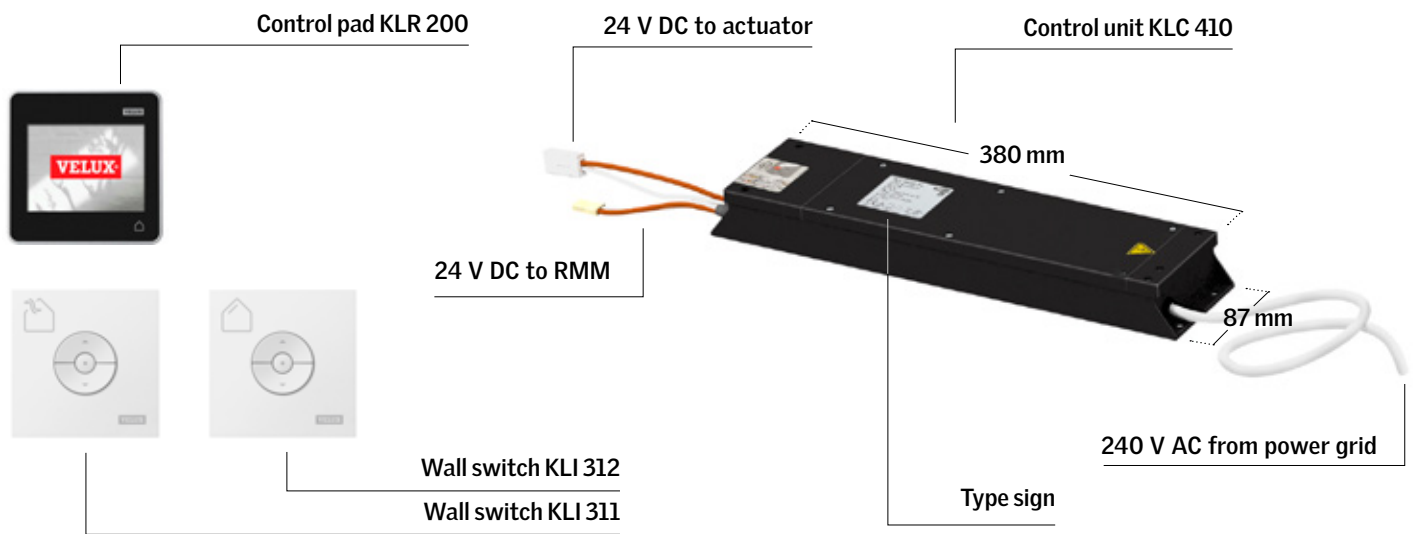

Open system

Venting modular skylights and roller blinds controlled with the open system solution are connected to ± 24 V DC. In addition to ± 24 V DC, the open system skylights and roller blinds can be connected to and integrated in common building automation fieldbus systems, i.e. KNX, BACnet, LON and Modbus.

The connection to the skylight actuator is made through the integrated WindowMaster MotorLink™ technology that among other things enables exact position control and feedback.

Roller blind

The internal roller blind RMM is designed for installation with VELUX Modular Skylights, and is available in all standard module sizes above 800 mm in height. The blind protects against heat and glare and helps to control the amount of light in the room.

The blind consists of four wheels, one in each corner of the skylight module and two steel wires, running along the module side frame. The two wires pull a lightweight polyester fabric available in three commonly used colours.

VELUX roller blinds are electrically operated and can be controlled using either VELUX INTEGRA® or Open System $\pm 24V$ (OS $\pm 24V$ DC).

To support fast and safe installation of VELUX Modular Skylights, it is possible to order roller blinds pre-mounted from the factory, except on smoke venting modules and fire resistant modules.

VELUX Modular Skylights can be pre-fitted with cables for internal roller blinds, making the installation and connection to the module and to the power supply quick and easy. For more information, see page 107-109.

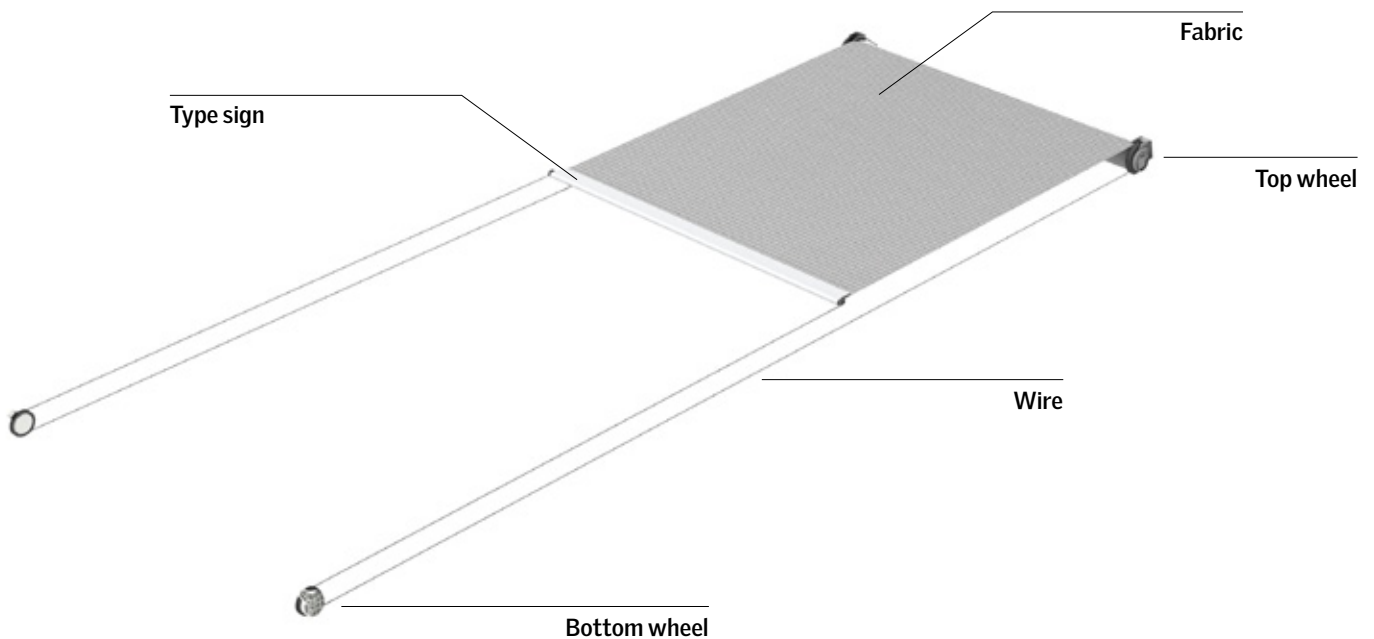

The blind cloth of VELUX roller blinds is pulled on two tension steel wires on pulley wheels, which are accessible, when the roller blinds are installed on skylights within reach and therefore can cause serious injury, if a person gets in contact with this during the electrical operation of the blind. VELUX roller blinds have a recommended minimum installation height of 2.5 m above floor level (inside) and ground level (outside). In case of installation below that level, safety measures must be applied by the installer/user to prevent serious injury. No instruction or measure can eliminate the inherent hazards resulting from installation heights below 2.5 m.

We recommend you to observe national regulations and consider if the planned specific use of the building requires that additional safety measures must be applied by the installer/user to prevent serious injury.

The VELUX Group will not accept responsibility for damages, injury or death resulting from such installation. The installer/user is ultimately responsible for own omissions and actions. Measures could for instance be to install a motion sensor that is able to disconnect power from the control unit in case of any movement in the immediate vicinity of the VELUX Modular Skylights.

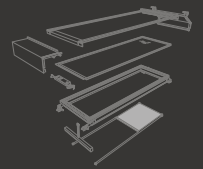

Fire retardant sun screening

Fire retardant sun screening			
Colour: Variant code	Grey RMM 8805	White RMM 8806	Black RMM 8807

Order the right size
 To order the right sizes see the type sign on the VELUX modular skylight.
 How to read the type sign, see page 43.

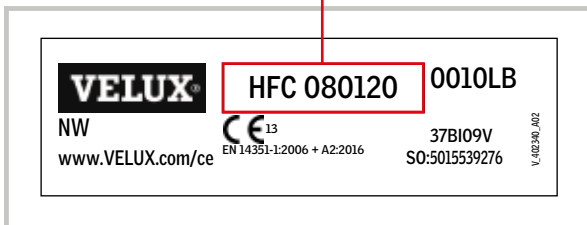

Beam for Ridgelight at 5°

When installing VELUX Modular Skylights in a 5° Ridgelight solution, the modules are supported by a steel beam. There are two beam design options. You can choose either the horizontal beam with rectangular profile or the parallel beam with curved profile.

The beam is included in the VELUX delivery and is ready for fast and easy installation with no further preparation.

VELUX beams are treated with final coating, white RAL 9010, gloss 30 as standard and are available for modules from 800 to 3000 mm in height.

Fire resistance

If the beam is required to meet increased demands for fire resistance, for instance used together with a fire resistant skylight module HFS, it must be treated with fire paint. If such a demand occurs, please be advised:

For up to 30 minutes of fire resistance, clients will need to:

- purchase modules with fire resistant glazing units and intumescent strip (HFS).
- purchase the corresponding beam variant coated with fire resistant paint system providing 30 minutes of resistance to fire to the whole application.

Customers are advised to inform the local VELUX sales company of such demands prior to order, as standard beams are not coated with fire resistant paint system but with standard paint as default, and the applied standard paint system is not compatible for post application of fire protection paint systems. Please note that fire paint will change the visual appearance of the beams slightly.

If there are no specific fire rating demands for the modules, but specific demands for the beams, only point b) is relevant.

Always take into consideration that it is only possible to make beams fire rated for up to 30 minutes. If fire rating demands exceed 30 minutes, 5° Ridgelight configurations are not suited for this installation.

Beam for Ridgelight at 5°

Horizontal beam with rectangular profile

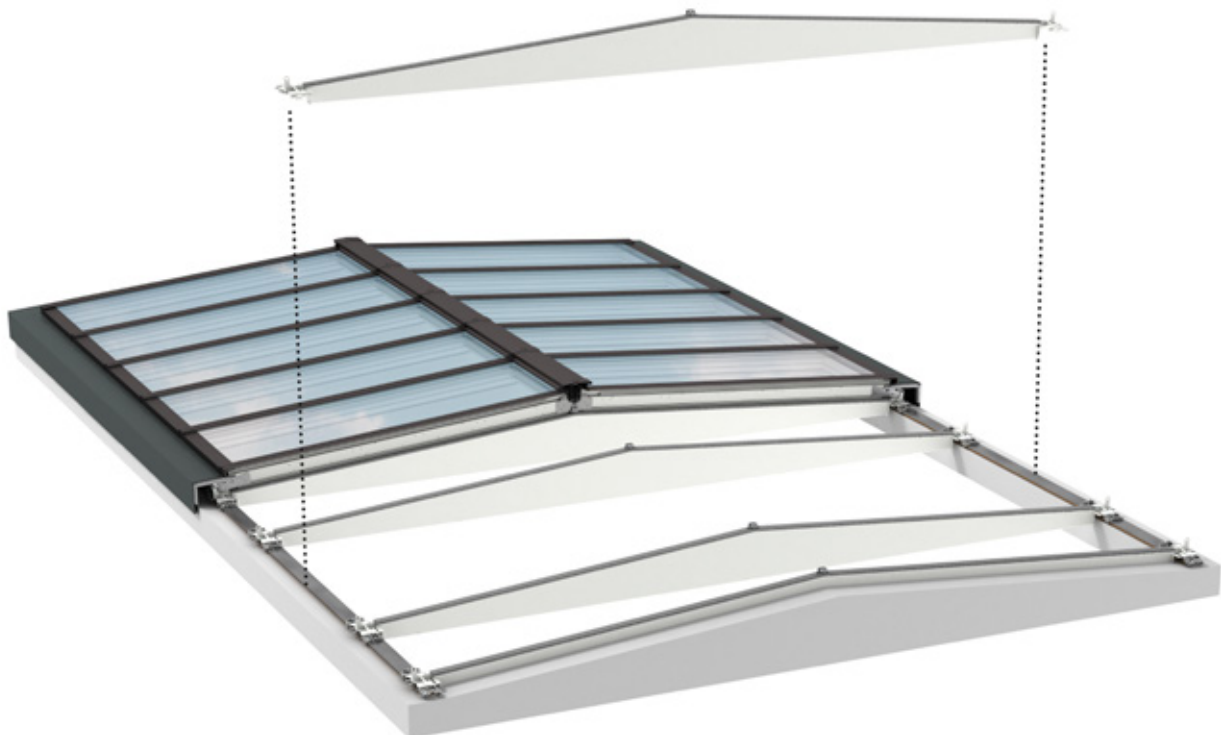

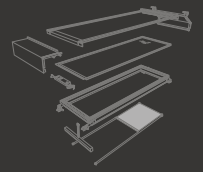

Horizontal beam with rectangular profile



Parallel beam with curved profile

Beam for Ridgelight at 5°

Parallel beam with curved profile

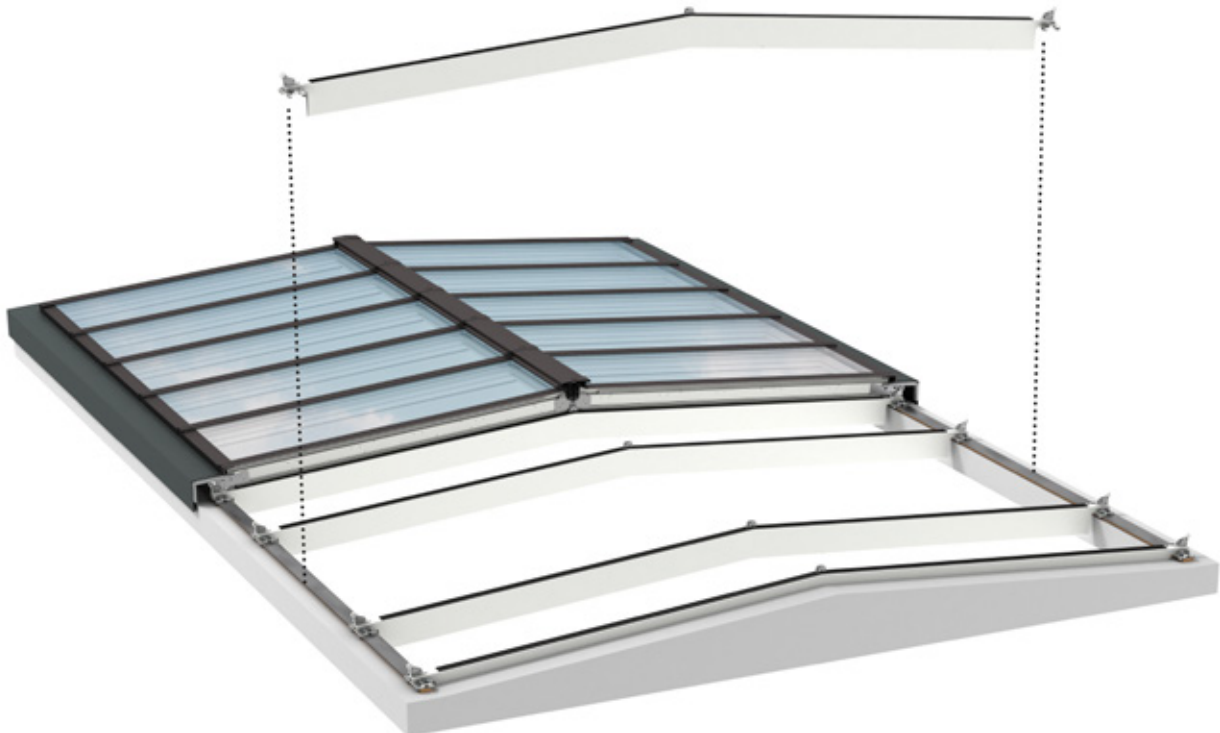

Wind deflector for smoke ventilation modules

The wind deflectors are intended for use with smoke venting modular skylights. The wind deflectors are designed to change the wind profile over the skylights in open position, in order to minimize the risk of air intake and allow outtake of smoke even under unfavorable wind conditions, and at the same time causing the least possible visual effect on the exterior of the skylight. The wind deflectors come in two variants: KCD W00H00 0040 that covers one smoke venting module and KCD 0080 that covers three modules, one smoke venting module in the middle of two fixed modules of the same width.

The deflectors are tested together with VELUX Modular Skylights in accordance with EN 12101-2.

The wind deflector can be purchased and installed at the same time as the smoke ventilator, or they can be installed subsequently, if the skylight configuration allows this. In any case, the aerodynamic free area of the smoke ventilators is declared both with and without wind deflectors and the influence of the deflectors on the performance must be respected.

For further information on the performance of smoke venting modular skylights, the influence of the deflector on the aerodynamic free area and the design possibilities, see pages 87-97.

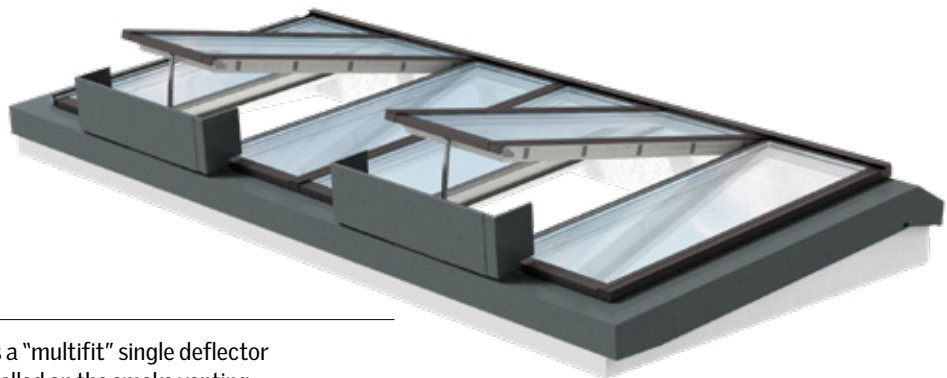

Wind deflector KCD 0040

Wind deflector KCD W00H00 0040 is a "multifit" single deflector for all module sizes. The deflector is installed on the smoke venting module, one deflector for each module.

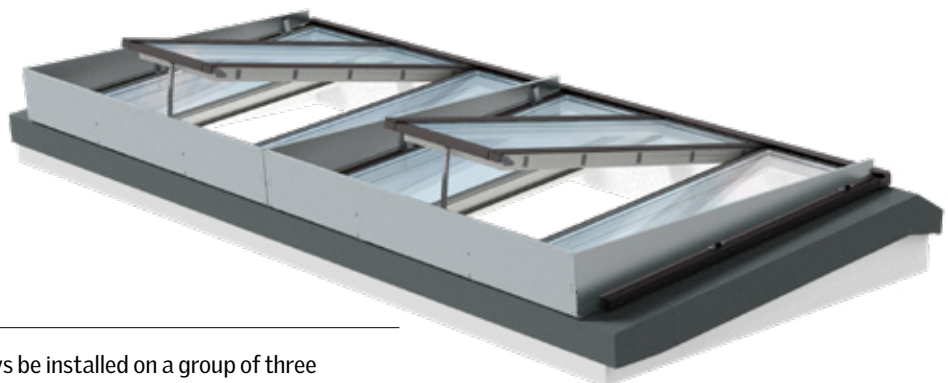

Wind deflector KCD 0080

Wind deflector KCD 0080 must always be installed on a group of three skylight modules with identical width, where the middle module is the smoke ventilator and the two modules at the sides are fixed modules. This deflector is manufactured to fit the size of the three modules it is installed on.

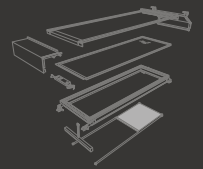

Type sign

All VELUX Modular Skylights, electrical components and accessory products have a type sign sticker. The type sign helps to identify the product and must NOT be removed.

If a product is damaged or malfunctioning, the information on the type sign must be given to the VELUX sales company.



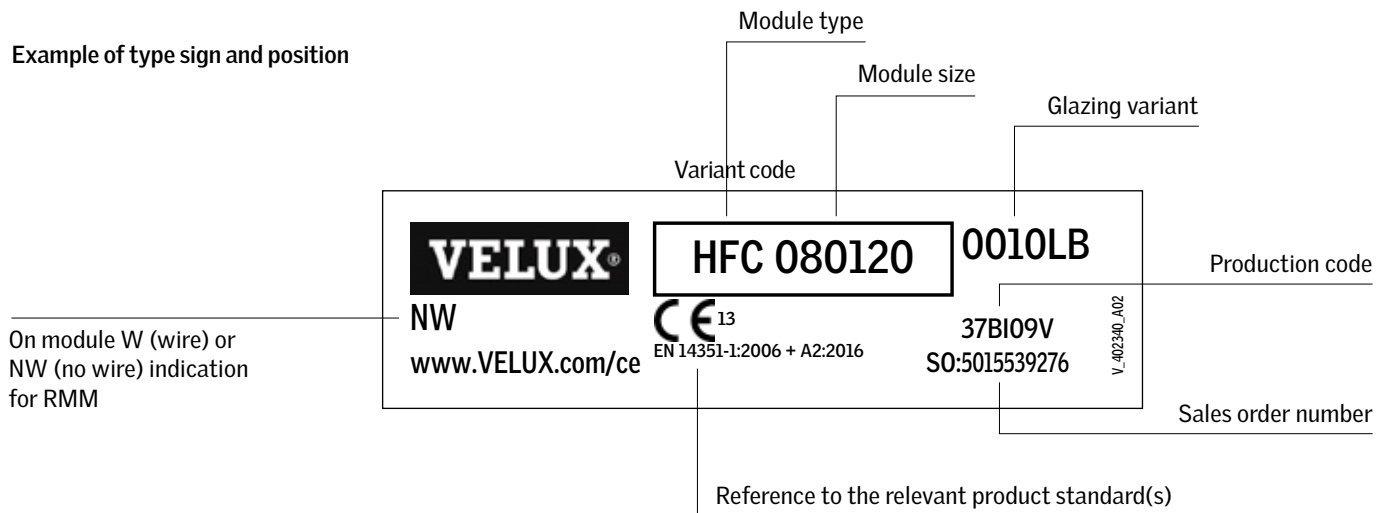







Example of type sign and position



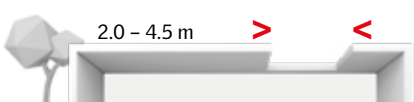

Solutions

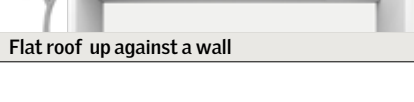
Quick overview of skylight solutions vs. roof constructions

						
Solution*	Longlight		Wall-mounted Longlight	Northlight		
Installation pitch	5-30°		5-45°	25-90°		
HFC = fixed modules, HVC = venting modules	HFC	HVC	HFC	HVC	HFC	HVC
Opening width (Length = ∞) **	0.6 – 3.1 m	0.8 – 2.5 m	0.6 – 3.2 m	0.8 – 2.6 m	0.6 – 3.1 m	0.8 – 2.5 m
 1.2 – 2.5 m > <	✓					
Flat roof with small opening						
 2.0 – 4.5 m > <	✓					
Flat roof with medium opening						
 3.2 – 6.2 m > <						
Flat roof with large opening						
						
Flat roof with extra large opening (Atrium)						
			✓			
Flat roof up against a wall						
					✓	
Northlight						
	✓				✓	
Sloping roof with opening in the side						
						
Sloping roof with opening as ridge						

* Please note that all solutions, regardless of roof construction, require installation on a sub-construction designed according to instructions given by the VELUX Group.



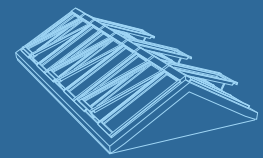



** Measurements are guidelines only. Exact numbers will be supplied by your VELUX sales company.

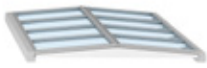
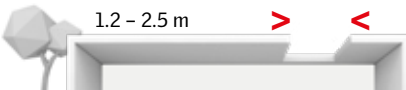
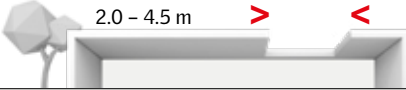

Idea catalogue on alternative construction possibilities and light distribution

Longlight	Wall-mounted Longlight	Northlight
Daylight in both an office and a corridor	Newbuild extension with wall-mounted solution	Daylight will be restricted in a 90° solution
Asymmetric room with a sloping roof	Buildings with different heights	A lower pitch creates more daylight inside
When a sloping roof cannot carry a Ridgeline	Opens up a corridor in a building	Northlight integrated in the roof construction
In a shaft between two buildings	Daylight into a basement	

Quick overview of skylight solutions vs. roof constructions

				
Solution*	Ridgelight		Ridgelight at 5° with Beams	
Installation pitch	25-40°		5°	
HFC = fixed modules, HVC = venting modules	HFC	HVC	HFC	HVC
Opening width (Length = ∞) **	1.4 - 4.5 m	1.4 - 4.5 m	1.8 - 6.2 m	1.8 - 5.0 m
 1.2 - 2.5 m > <	✓			
Flat roof with small opening			✓	
 2.0 - 4.5 m > <	✓		✓	
Flat roof with medium opening				
 3.2 - 6.2 m > <	✓		✓	
Flat roof with large opening				
				
Flat roof with extra large opening (Atrium)				
				
Flat roof up against a wall				
				
Northlight				
				
Sloping roof with opening in the side				
	✓			
Sloping roof with opening as ridge				

* Please note that all solutions, regardless of roof construction, require installation on a sub-construction designed according to instructions given by the VELUX Group.



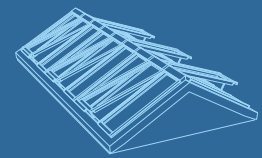





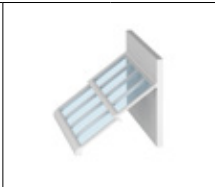

** Measurements are guidelines only. Exact numbers will be supplied by your VELUX sales company.

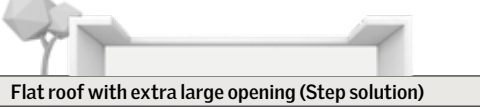

Idea catalogue on alternative construction possibilities and light distribution

<p>Ridgelight</p>	<p>Ridgelight at 5° with Beams</p>
<p>On top of a sloping roof</p>	<p>Solution for flat roof with a wide opening</p>
<p>Asymmetric Ridgelight with infill panel on south side blocking the excess sun</p>	

Quick overview of skylight solutions vs. roof constructions



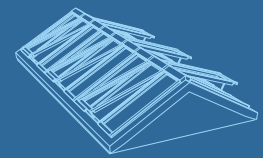

				
Solution*	Step Longlight	Step Wall-mounted Longlight	Step Ridgelight	Step Ridgelight on Girder
Installation pitch	5-25°		5-25°	25°
HFC = fixed modules, HVC = venting modules	HFC	HVC	HFC	HVC
Opening width (Length = ∞) **	2.6 – 18 m	2.6 – 18 m	2,6 – 18 m	2,6 – 18 m
	2.6 – 18 m	2,6 – 18 m	4.5 – 33 m	4.5 - 33 m
	2.6 – 18 m	2,6 – 18 m	6 – 36 m	6 - 36 m
 1.2 – 2.5 m > <				
Flat roof with small opening				
 2.0 – 4.5 m > <				
Flat roof with medium opening				
 3.2 – 6.2 m > <				
Flat roof with large opening				
	✓		✓	✓
Flat roof with extra large opening (Step solution)				
		✓		
Flat roof up against a wall				
				
Northlight				
	✓			
Sloping roof with opening in the side				
			✓	✓
Sloping roof with opening as ridge				

* Please note that all solutions, regardless of roof construction, require installation on a sub-construction designed according to instructions given by the VELUX Group.



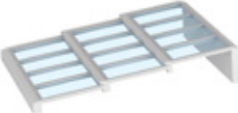



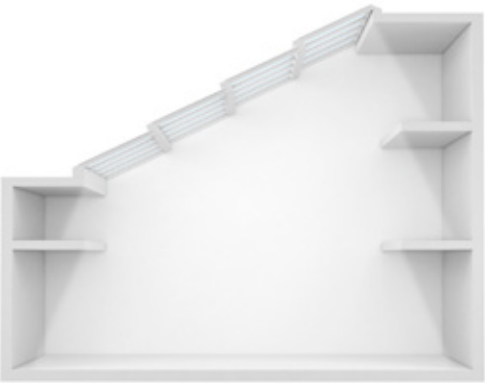
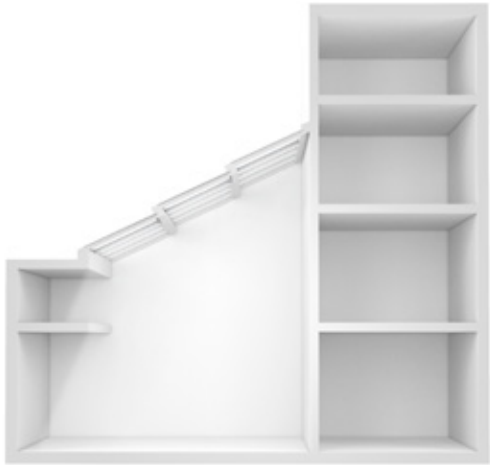
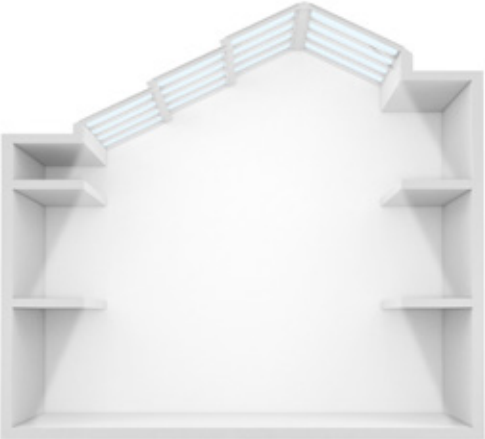
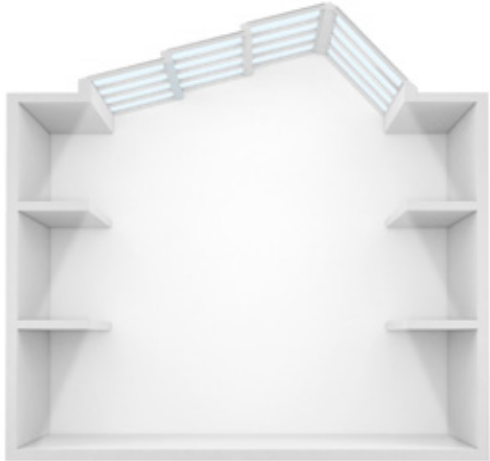

** Measurements are guidelines only. Exact numbers will be supplied by your VELUX sales company.

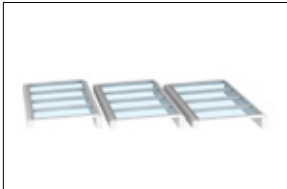
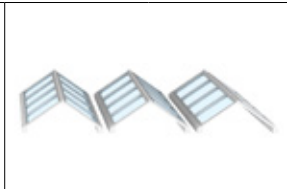
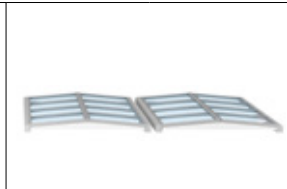

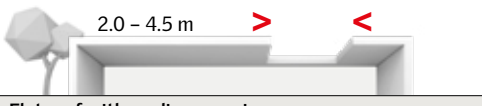
Idea catalogue on alternative construction possibilities and light distribution

			
Step Longlight	Step Wall-mounted Longlight	Step Ridgelight	Step Ridgelight on Girder
			
<p>A roof in two levels with Step Longlight</p>	<p>Two buildings in different height connected by a Step Wall-mounted Longlight</p>	<p>A roof in two levels with Step Ridgelight on Girder</p>	<p>A flat roof with a Step Ridgelight on Girder</p>

Quick overview of skylight solutions vs. roof constructions

						
Solution*	Atrium Longlight		Atrium Ridgelight		Atrium Ridgelight at 5° with Beams	
Installation pitch	5-30°		25-40°		5°	
HFC = fixed modules, HVC = venting modules	HFC	HVC	HFC	HVC	HFC	HVC
Opening width (Length = ∞) **	0.6 - 3.1 m	0.8 - 2.5 m	1.4 - 4.5 m	1.4 - 4.5 m	1.8 - 6.2 m	1.8 - 5.0 m
 1.2 - 2.5 m > <						
Flat roof with small opening						
 2.0 - 4.5 m > <						
Flat roof with medium opening						
 3.2 - 6.2 m > <						
Flat roof with large opening						
	✓		✓		✓	
Flat roof with extra large opening (Atrium)						
						
Flat roof up against a wall						
						
Northlight						
						
Sloping roof with opening in the side						
						
Sloping roof with opening as ridge						

* Please note that all solutions, regardless of roof construction, require installation on a sub-construction designed according to instructions given by the VELUX Group.
 ** Measurements are guidelines only. Exact numbers will be supplied by your VELUX sales company.

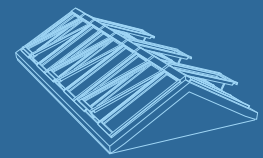

Idea catalogue on alternative construction possibilities and light distribution



Atrium Longlight



Atrium Ridgelight



Atrium Ridgelight at 5°
with Beams

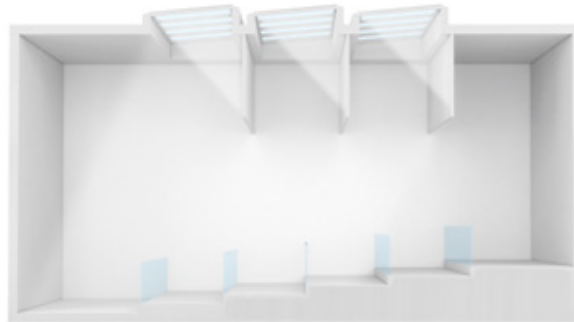

Atrium Longlight with internal sun screening. Design ideas like internal vertical sun screening are not supplied by the VELUX Group

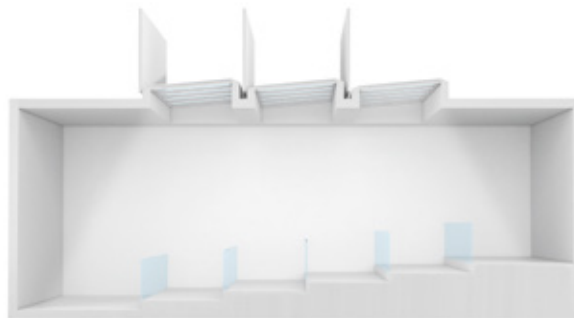

Atrium Longlight with external sun screening. Design ideas like vertical sun screening are not supplied by the VELUX Group



Atrium Longlight with sun louvres. Design ideas like sun louvres are not supplied by the VELUX Group

Longlight 5-30°

Longlights are bands of VELUX Modular Skylights, supplied with installation brackets and clamps that guarantee a fast and secure installation. The prefabricated flashing allows for configurations with a pitch of 5 to 30°.

Longlights are mounted on a standard steel profile, 100 mm wide (not a VELUX component). The brackets are fixed with a clamping system holding the skylights in place. It is also possible to install the mounting brackets of a Longlight directly onto a wooden batten without using the clamps.

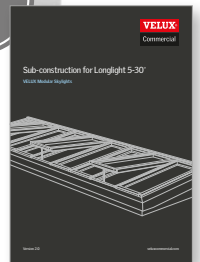
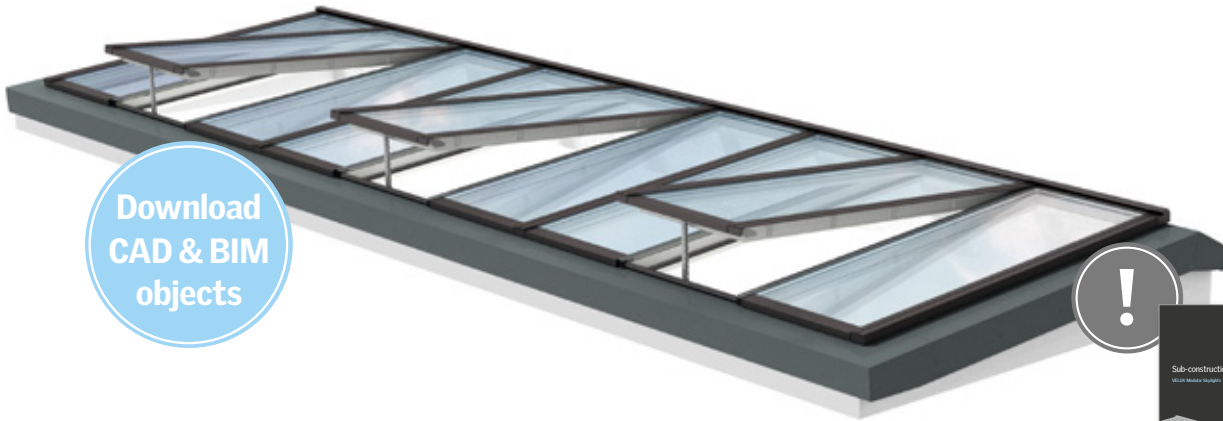

Sub-construction for Longlight at: veluxcommercial.com

Use the table to define module height (H) and/or installation pitch (α).

Example:
A = 1875 mm

Result:
 $\alpha 1$: H = 1800 mm at an installation pitch of 13°
or
 $\alpha 2$: H = 2000 mm at an installation pitch of 28°

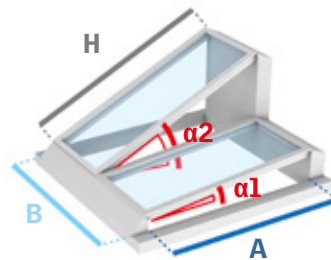

H: Module height
 α : Installation pitch
A: Opening width
B: Opening length

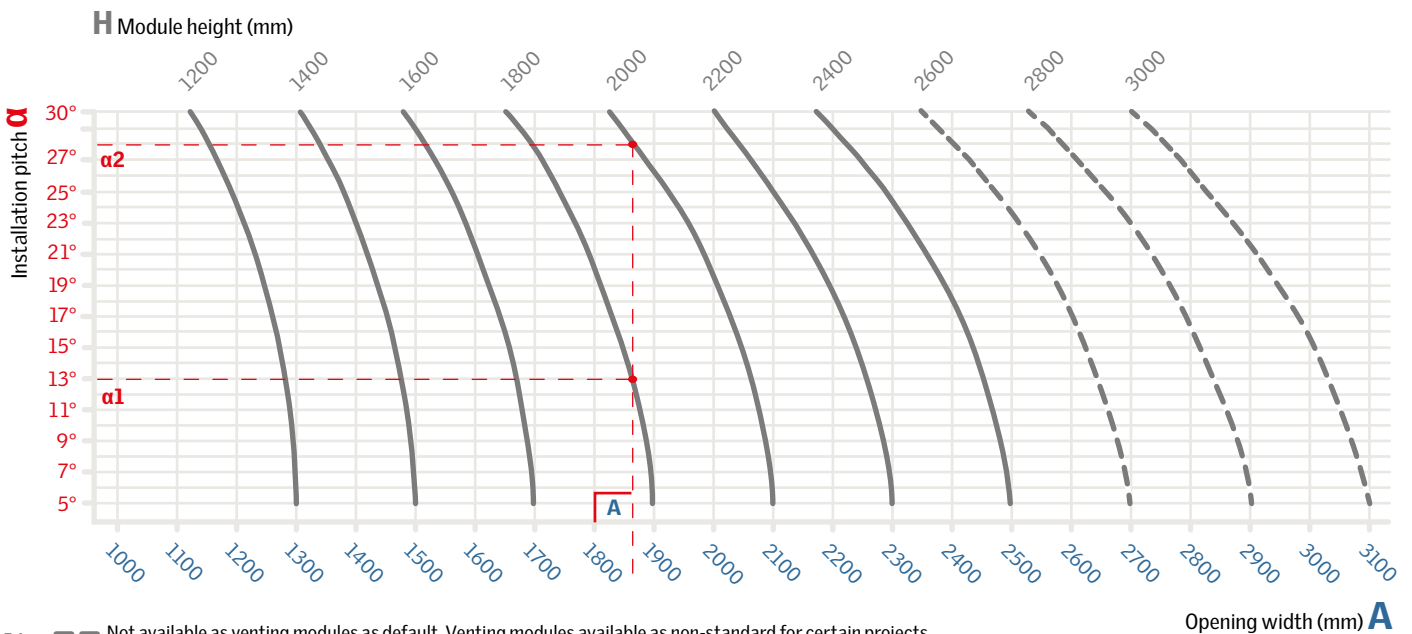

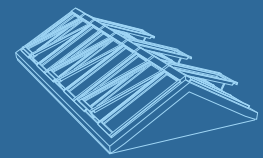

Sectional drawings

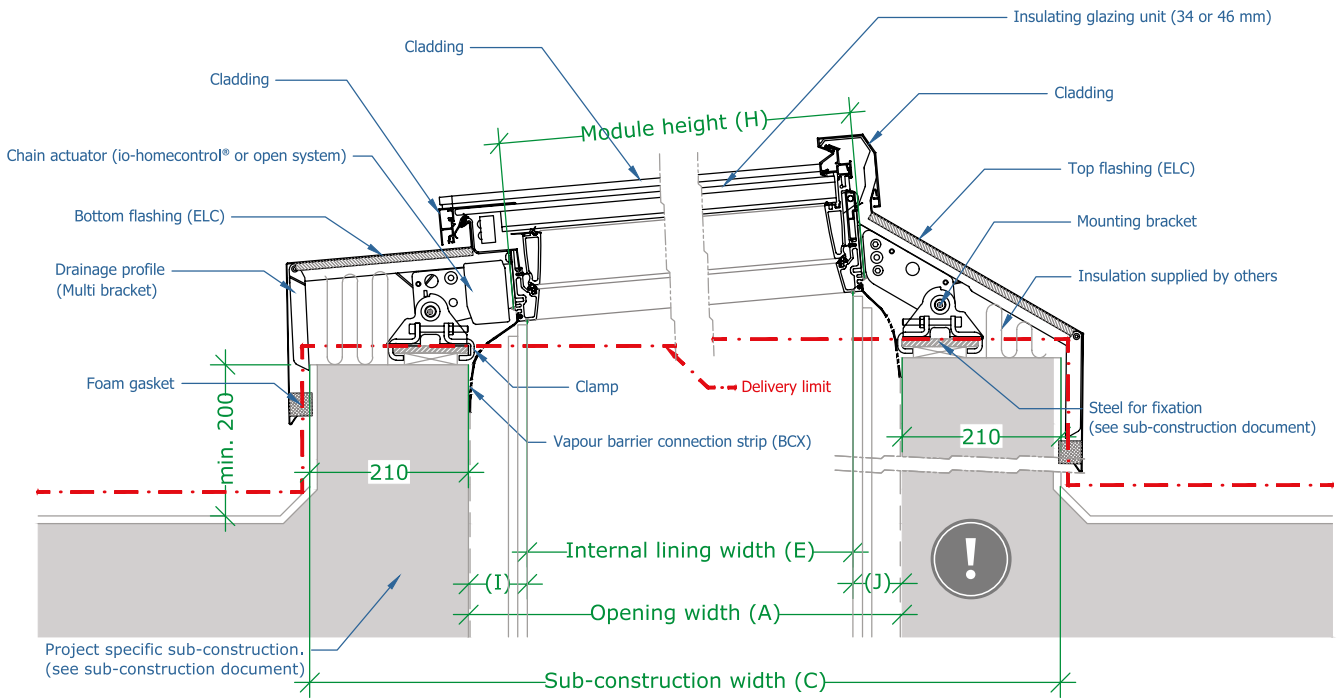

Cross-section - bottom

Cross-section - top

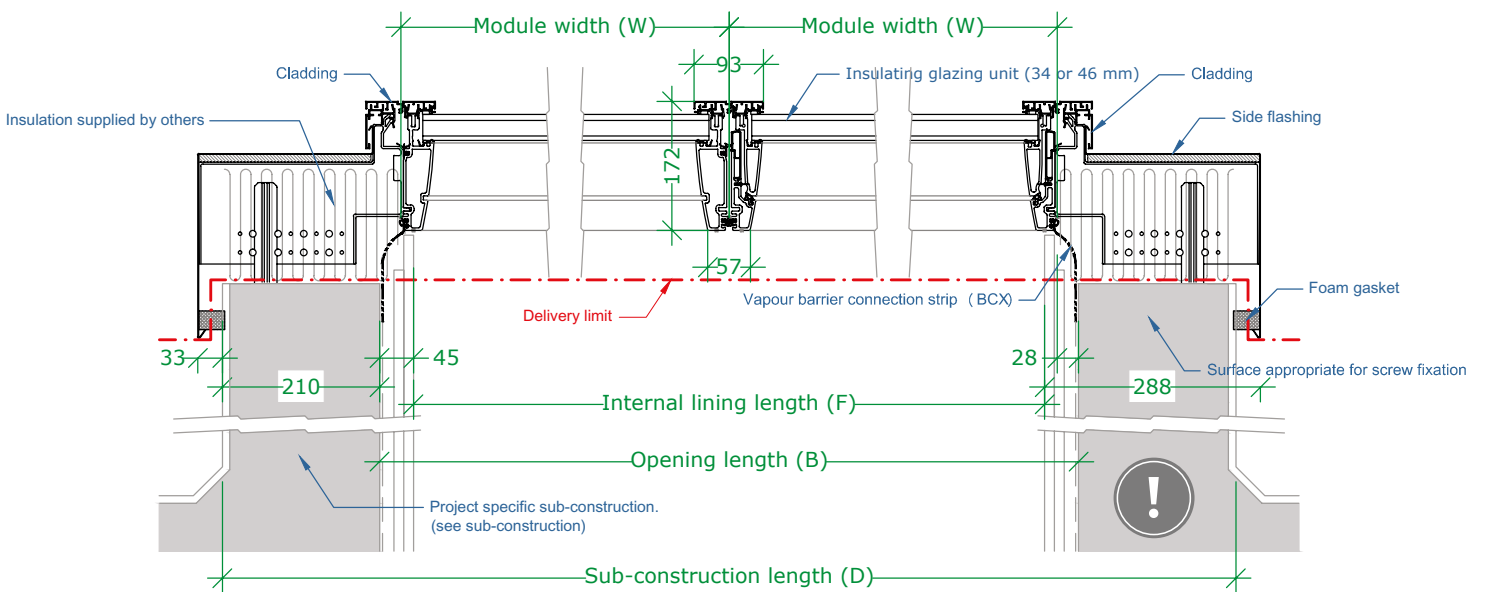

Longitudinal section

Please observe that a lateral slope on the modules is NOT possible, therefore top and bottom sub-construction must be horizontal.

Wall-mounted Longlight 5-45°

Wall-mounted Longlights are bands of VELUX Modular Skylights mounted against a vertical wall. As the skylight modules are supplied with installation brackets and clamps, a fast and secure installation is guaranteed. The flashing allows for configurations with a pitch of 5° to 45°.

Wall-mounted Longlights are mounted on a standard steel profile, 100 mm wide at the wall. At the bottom, you can choose to mount the skylights on either a steel profile using the clamping system or directly onto a wooden batten without using the clamps. The steel profiles and wooden battens are not VELUX components. Please observe a max. 3 m wall height above skylight module.



Download
CAD & BIM
objects



Sub-construction for
Wall-mounted Longlight at:
veluxcommercial.com

Use the table to define module height (H) and/or installation pitch (α).

Example:
A = 1700 mm

Result:
α1: H = 1600 mm at an installation pitch of 20°
or
α2: H = 1800 mm at an installation pitch of 31°
or
α3: H = 2000 mm at an installation pitch of 39°
or
α4: H = 2200 mm at an installation pitch of 44°

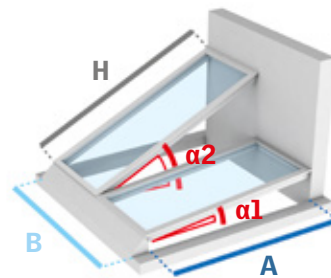

H: Module height
α: Installation pitch
A: Opening width
B: Opening length

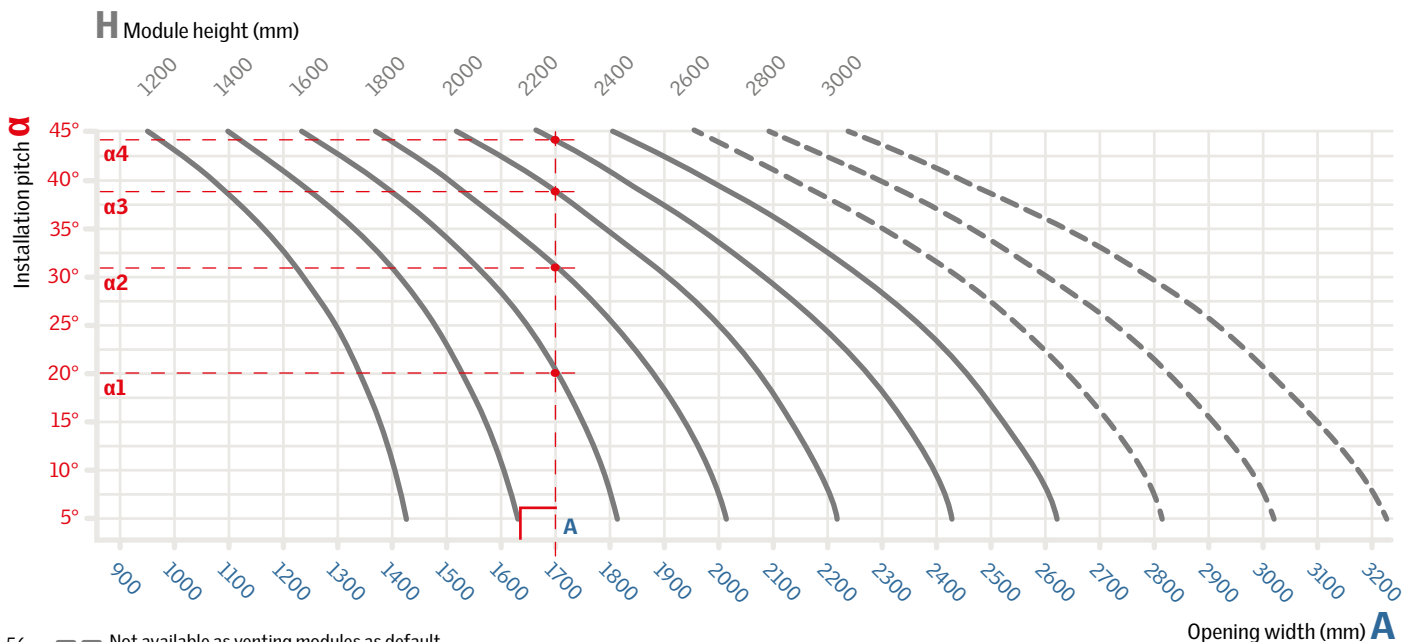

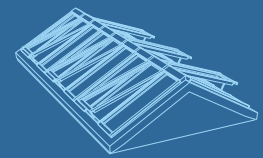

Sectional drawings

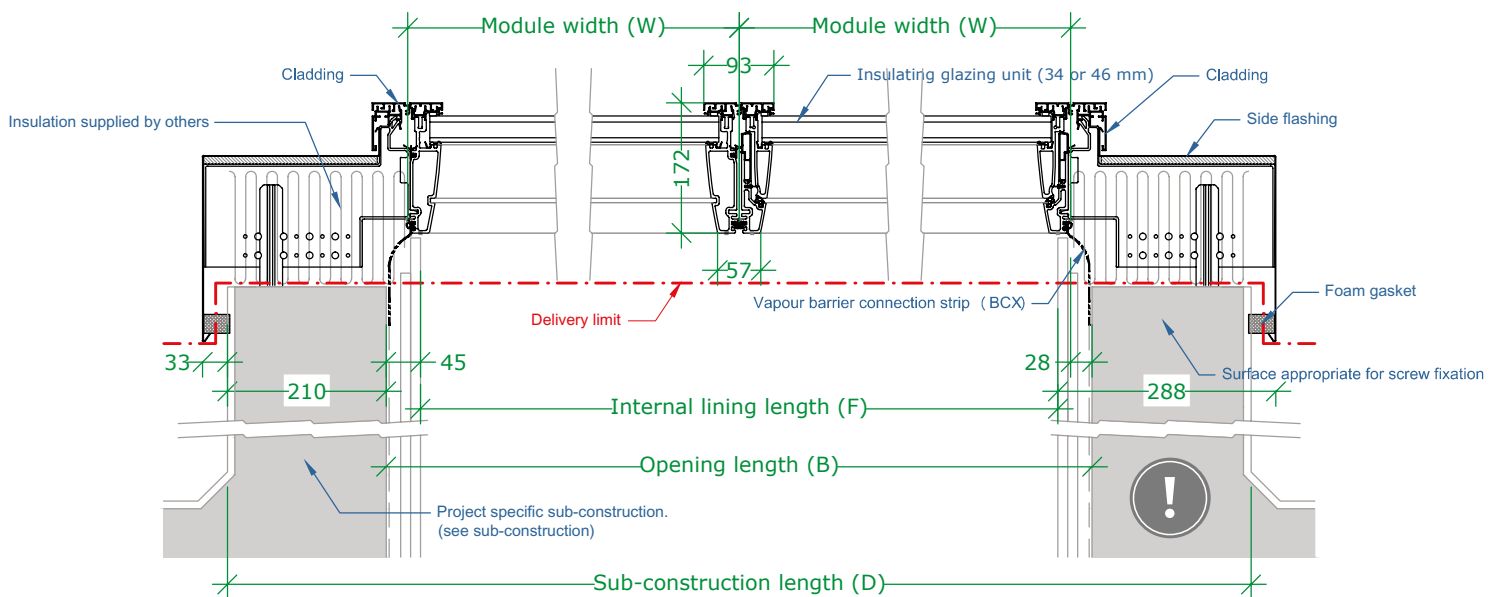
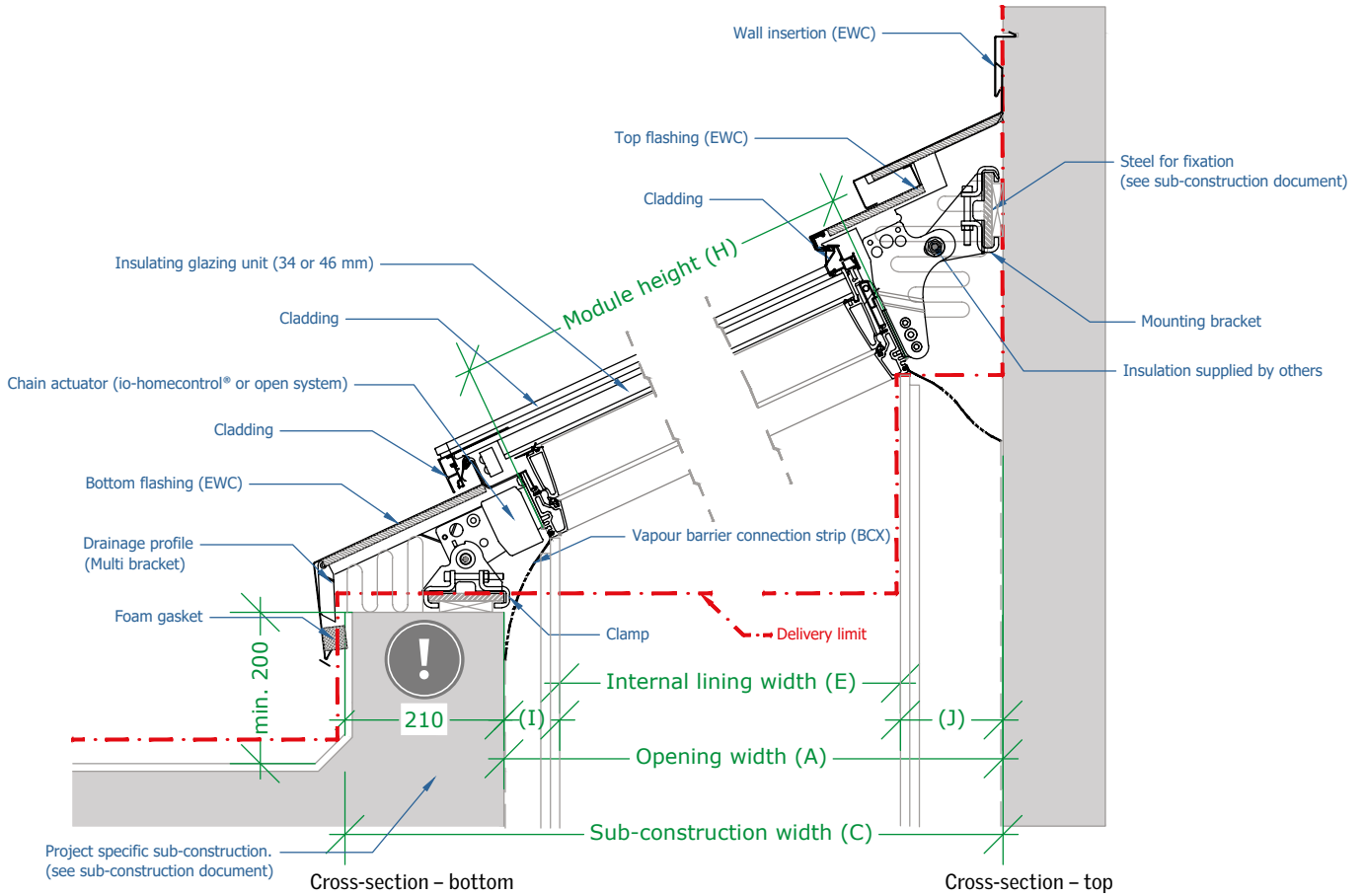

Longitudinal section

Please observe that a lateral slope on the modules is NOT possible, therefore top and bottom sub-construction must be horizontal.

Northlight 25-90°

Similar to Longlights, Northlights are bands of VELUX Modular Skylights. The characteristic upright design is primarily for installations that are directed towards the northern hemisphere for soft and reflected lighting. Northlight installations are applicable for a pitch of 25 to 90°.

At the bottom, Northlights are mounted on a standard steel profile, 100 mm wide (not a VELUX component) and fixed with clamps holding the skylight in place. At the top, the brackets are fixed to the sub-construction with screws meant for wood.

The prefabricated modular flashing ensures easy integration in the roof surface. All flashings are easily installed. The roof surface underneath the flashing must be appropriate for screw fixation.

Please observe a max. 10 m wall height above skylight module, when installed in a sloped roof. Take notice that the top flashing changes in size above and below 54°, see sectional drawing page 59.

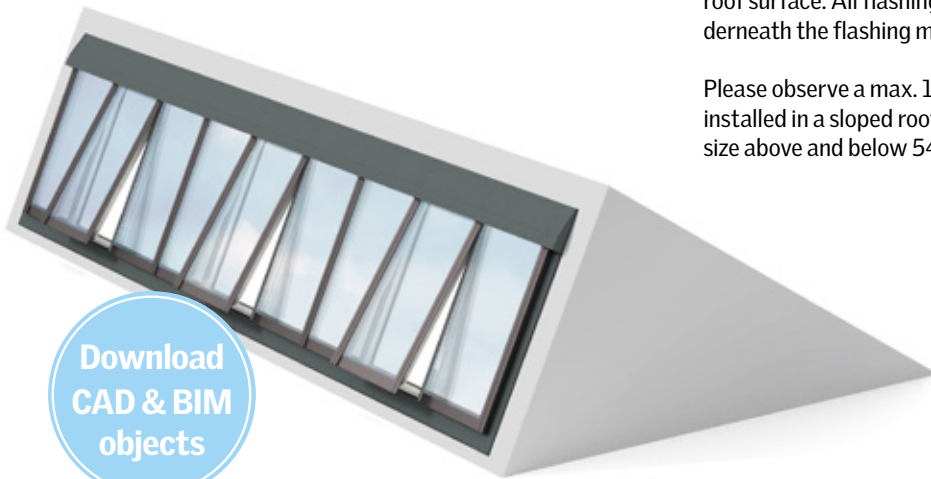

Download
CAD & BIM
objects

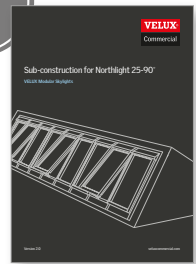

Sub-construction for
Northlight at:
veluxcommercial.com

Defining module size to your project

Example:

$\alpha 1$: H = 1600 mm at an installation pitch of 50°

A_{max} = 1680 mm
 A_{min} = 1566 mm

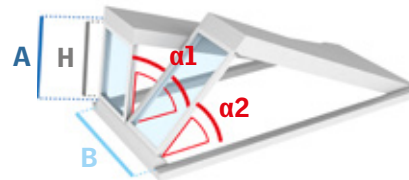

- H: Module height
- α : Installation pitch
- A: Opening width
- B: Opening length

Installation pitch α

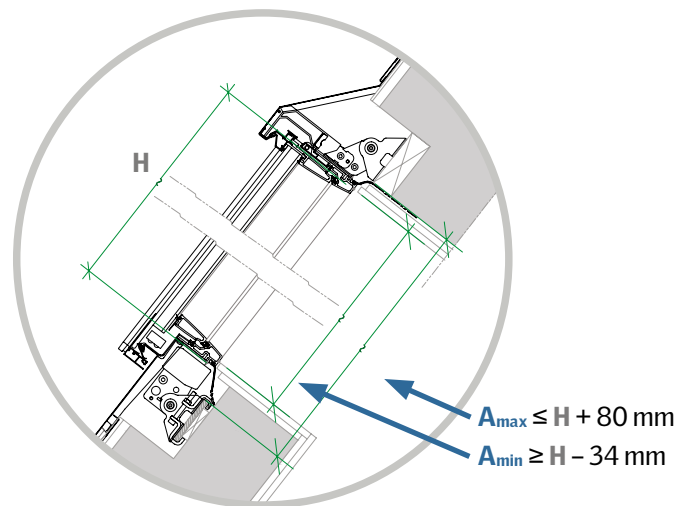
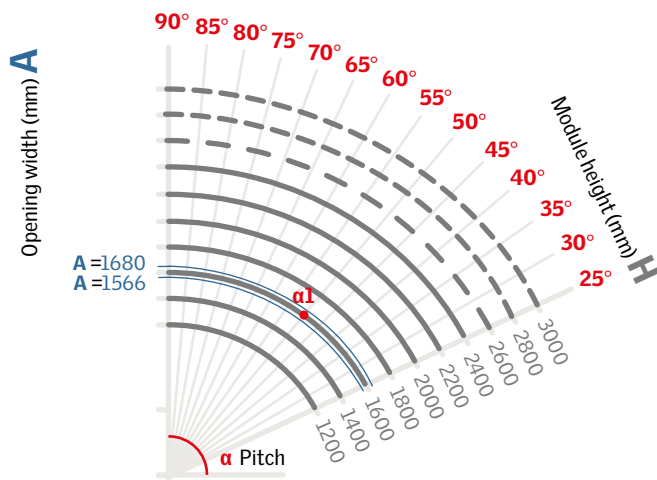

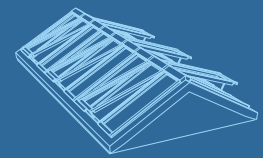

Sectional drawings

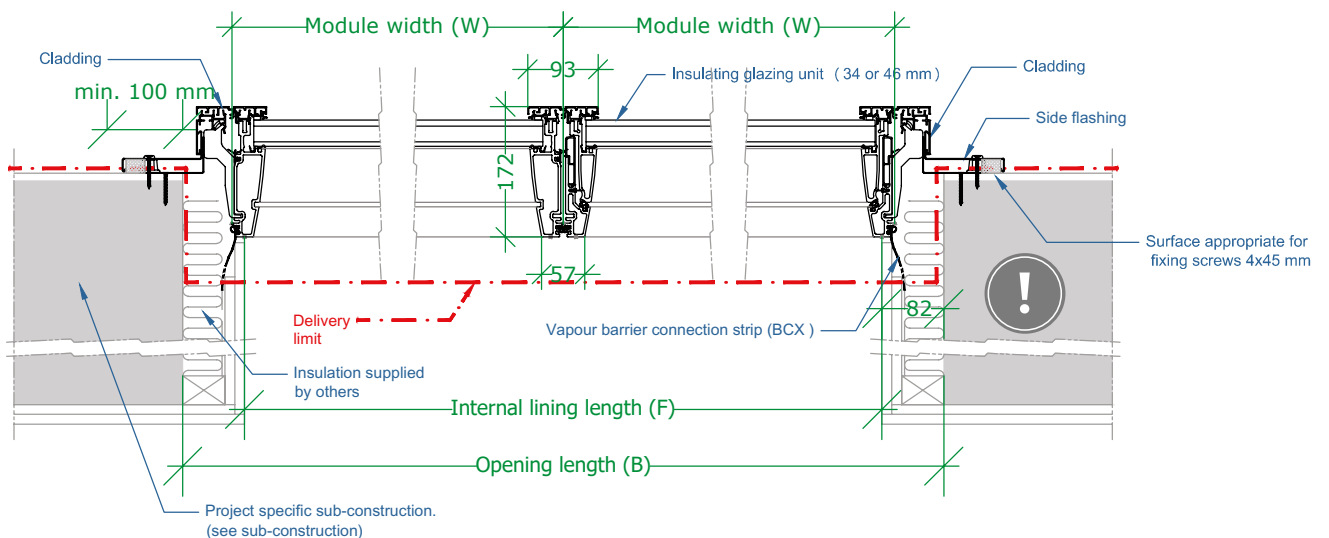
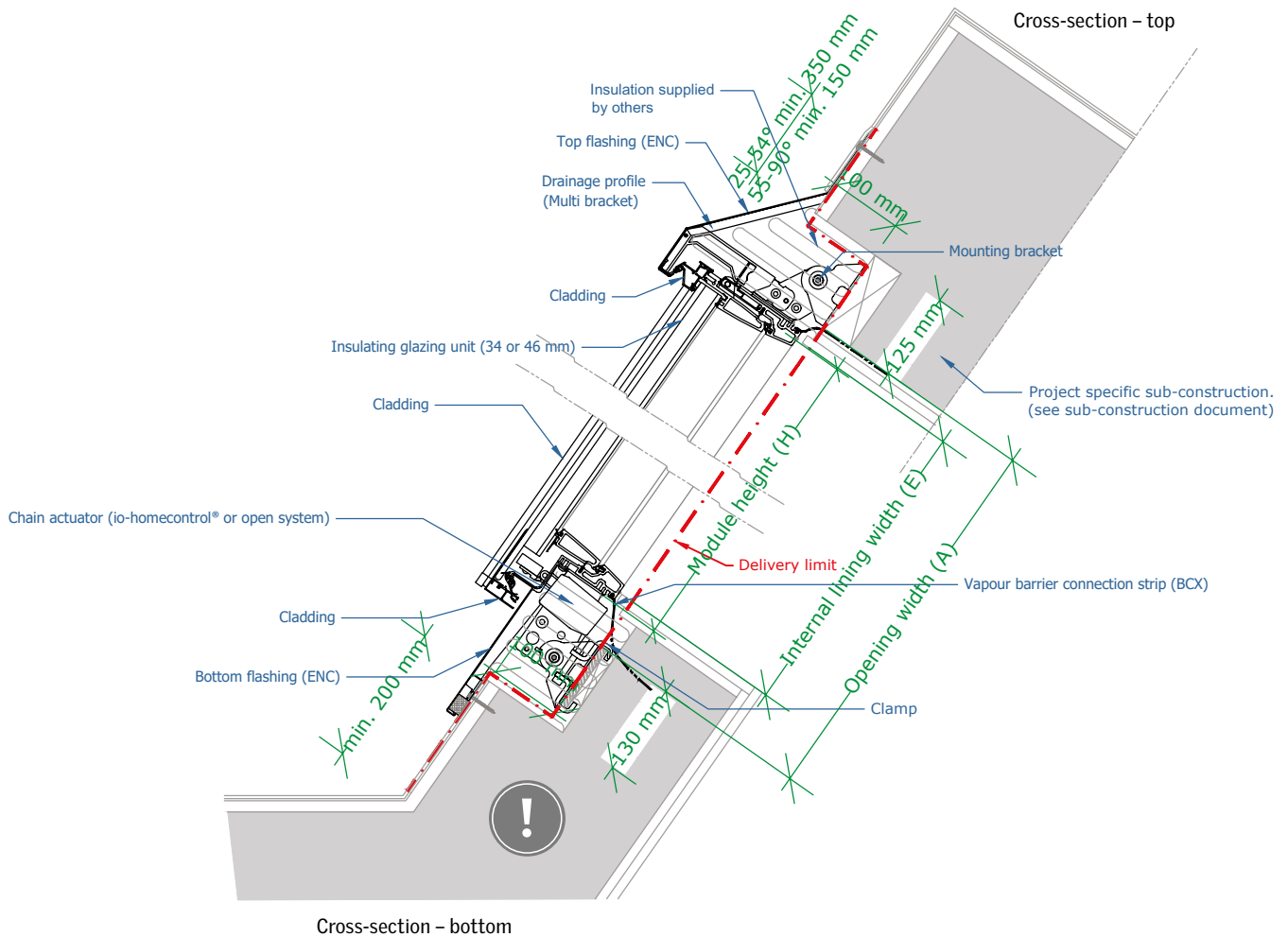

Please observe that a lateral slope on the modules is NOT possible, therefore top and bottom sub-construction must be horizontal.

Ridgelight 25-40°

Ridgelight is a classic solution, consisting of two rows of skylights linked together at the ridge, creating a self-supporting structure. The flashing allows for installations with a pitch of 25 to 40°.

Due to horizontal forces, it is recommended to use a sub-construction of steel or concrete when mounting a Ridgelight. Ridgelights are mounted on a standard steel profile, 100 mm wide (not a VELUX component). The brackets are fixed with a clamping system holding the skylights in place. It is not recommended to fasten the mounting brackets of a Ridgelight directly onto a wooden batten with screws.

Please observe that it is the designers responsibility to calculate the correct number and size of fixing if a wooden batten is used.

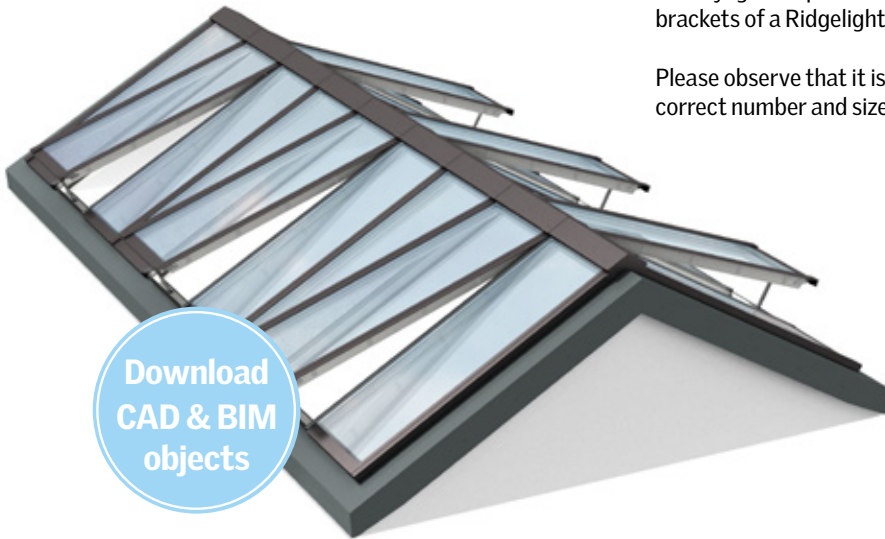

Download
CAD & BIM
objects

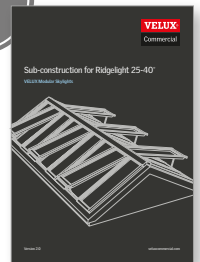

Sub-construction
for Ridgelight at:
veluxcommercial.com

Use the table to define module height (H) and/or installation pitch (α).

Example:
A = 3775 mm

Result:
α1: H = 2000 mm at an installation pitch of 26°
or
α2: H = 2200 mm at an installation pitch of 35.5°

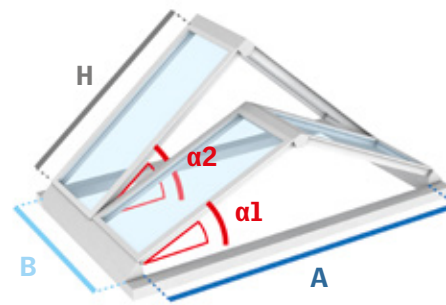

H: Module height
α: Installation pitch
A: Opening width
B: Opening length

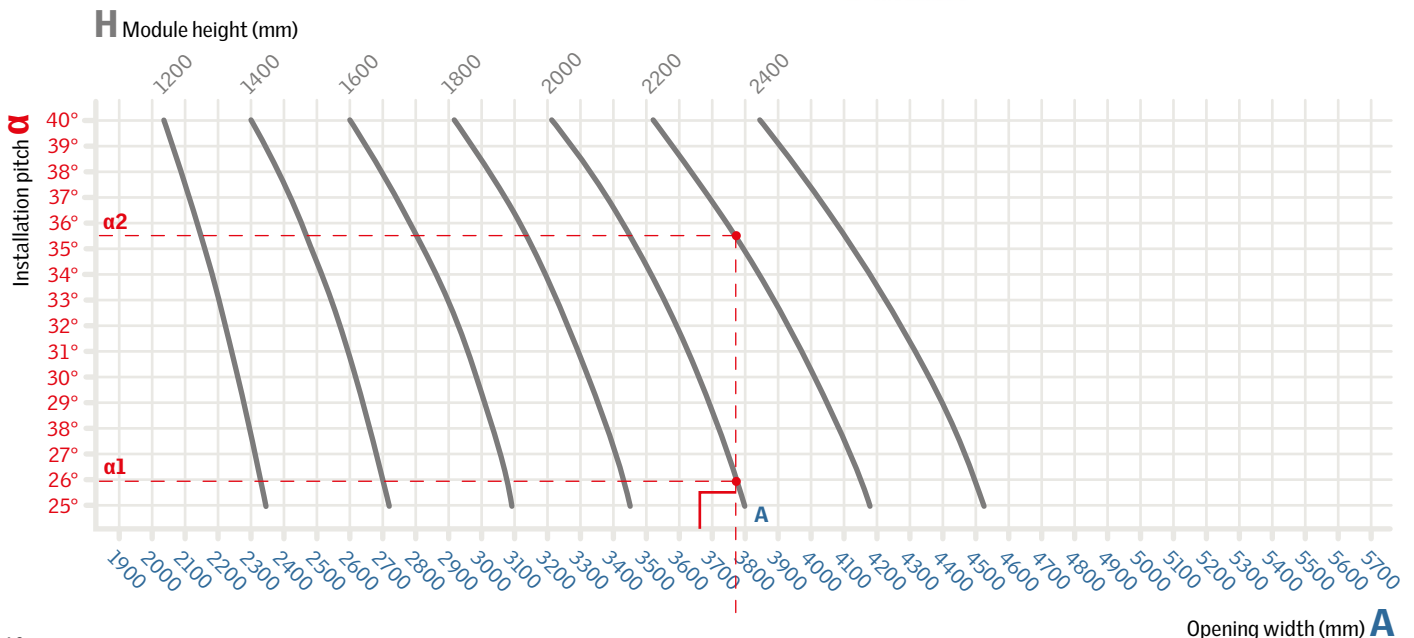

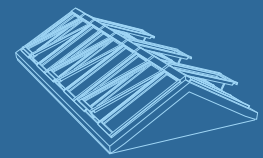

Sectional drawings

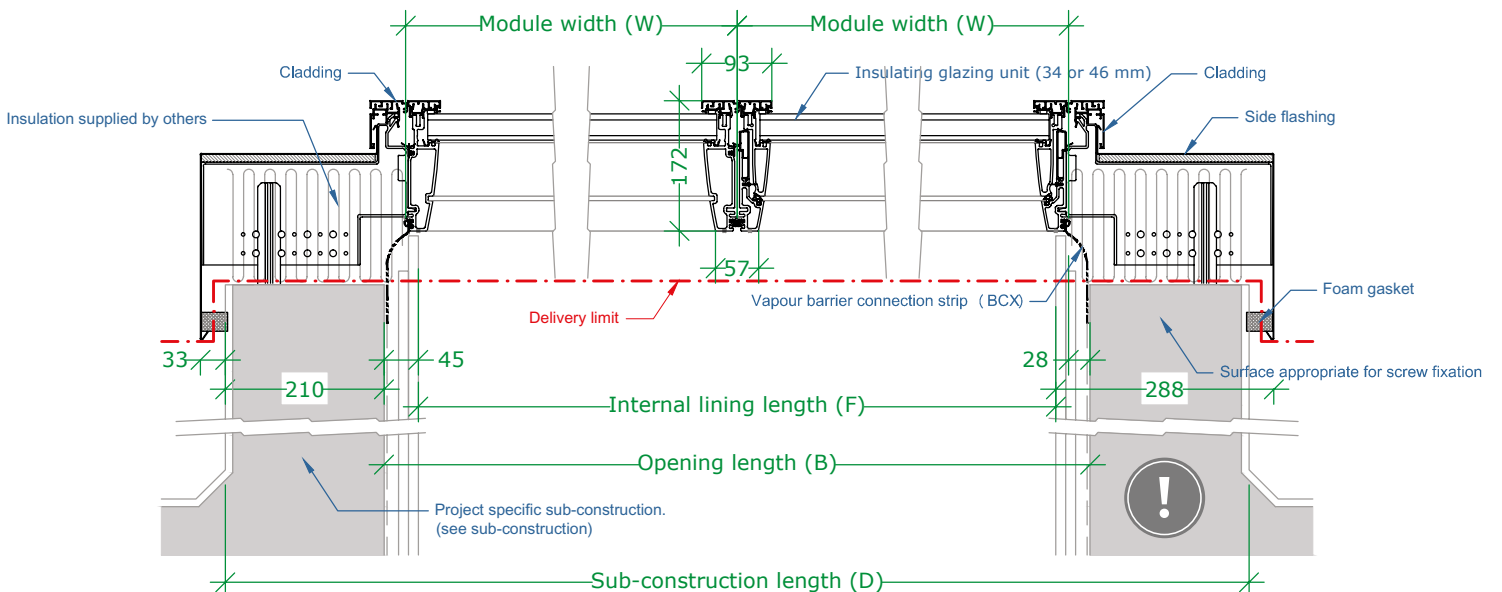
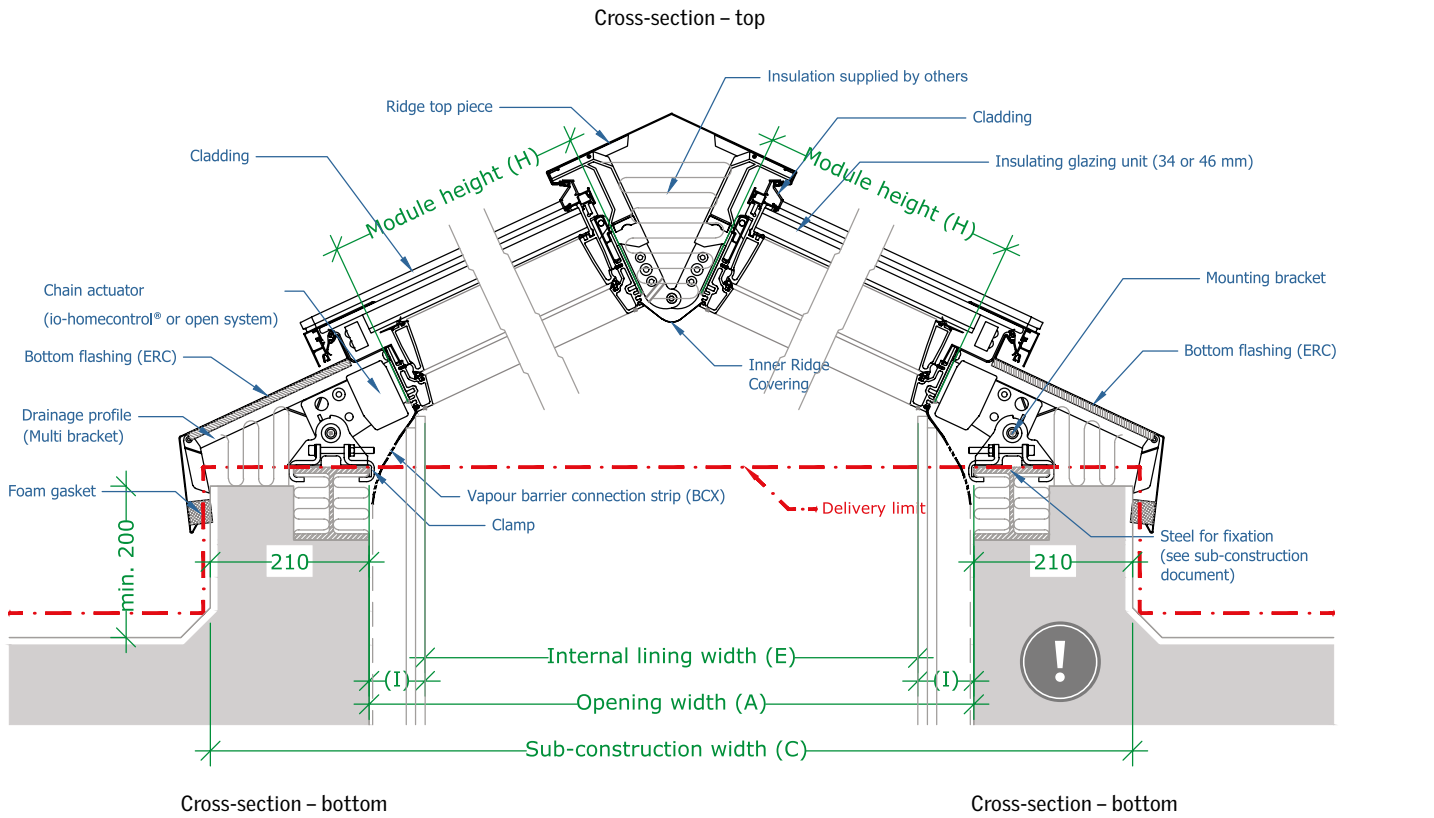

Please observe that a lateral slope on the modules is NOT possible, therefore top and bottom sub-construction must be horizontal.

Ridgelight at 5° with Beams (Horizontal beam with rectangular profile)

Ridgelights at 5° pitch guarantee the illusion of a small glass roof with discreet transverse horizontal supporting beams. The prefabricated VELUX beam supports the skylights and creates

the 5° pitch. The beams are mounted on a standard steel profile, 100 mm wide (not a VELUX component), on top of the sub-construction.

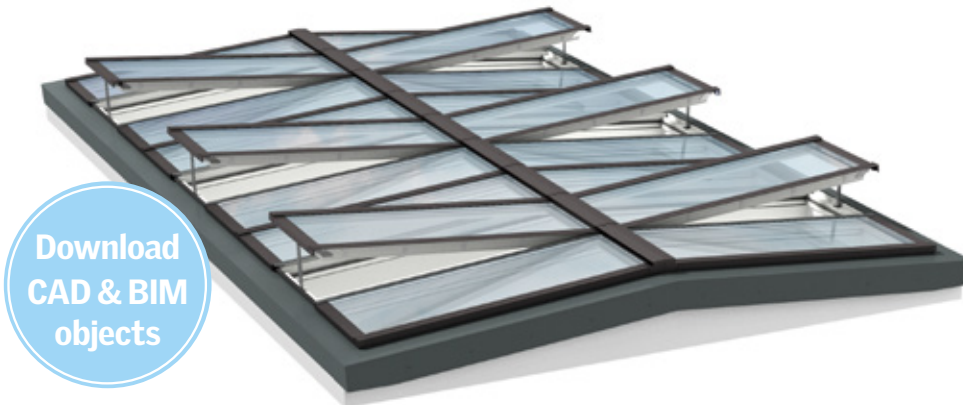

Download CAD & BIM objects

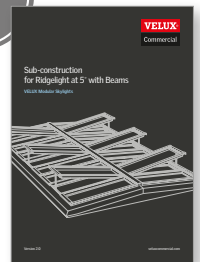

Sub-construction for Ridgelight at 5° with Beams at: veluxcommercial.com

Use the table to define module height (H) and/or installation pitch (α).

Example:
A = 4975 mm

Result:
α: H = 2400 mm at an installation pitch of 5°

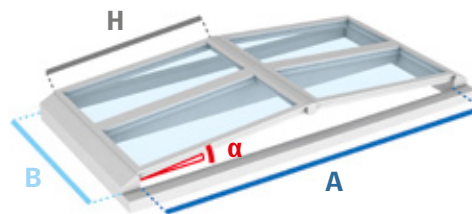

- H: Module height
- α: Installation pitch
- A: Opening width
- B: Opening length

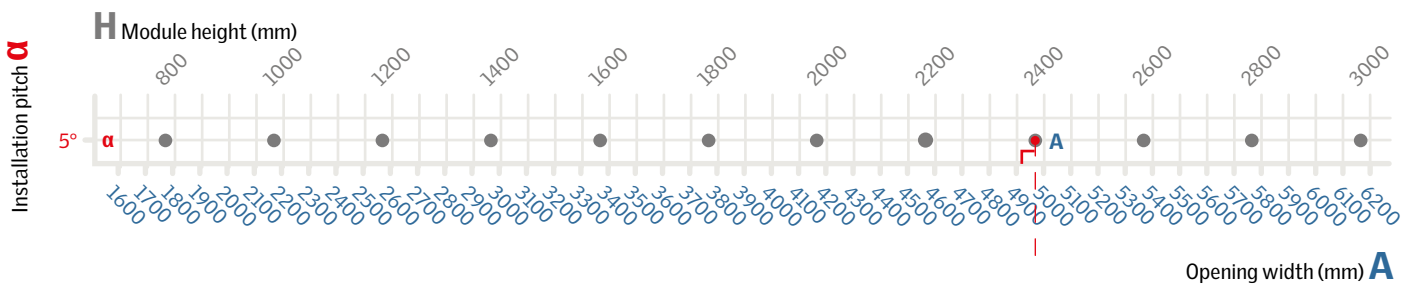

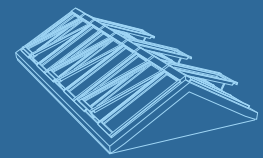

Sectional drawings

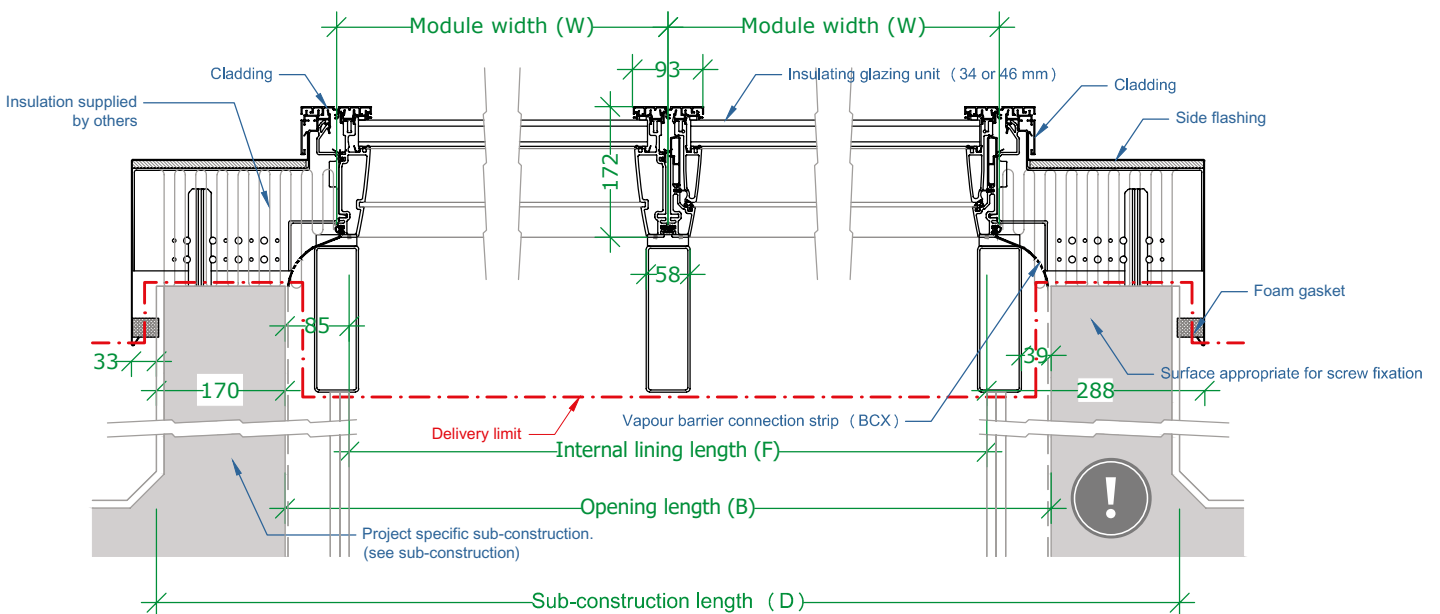
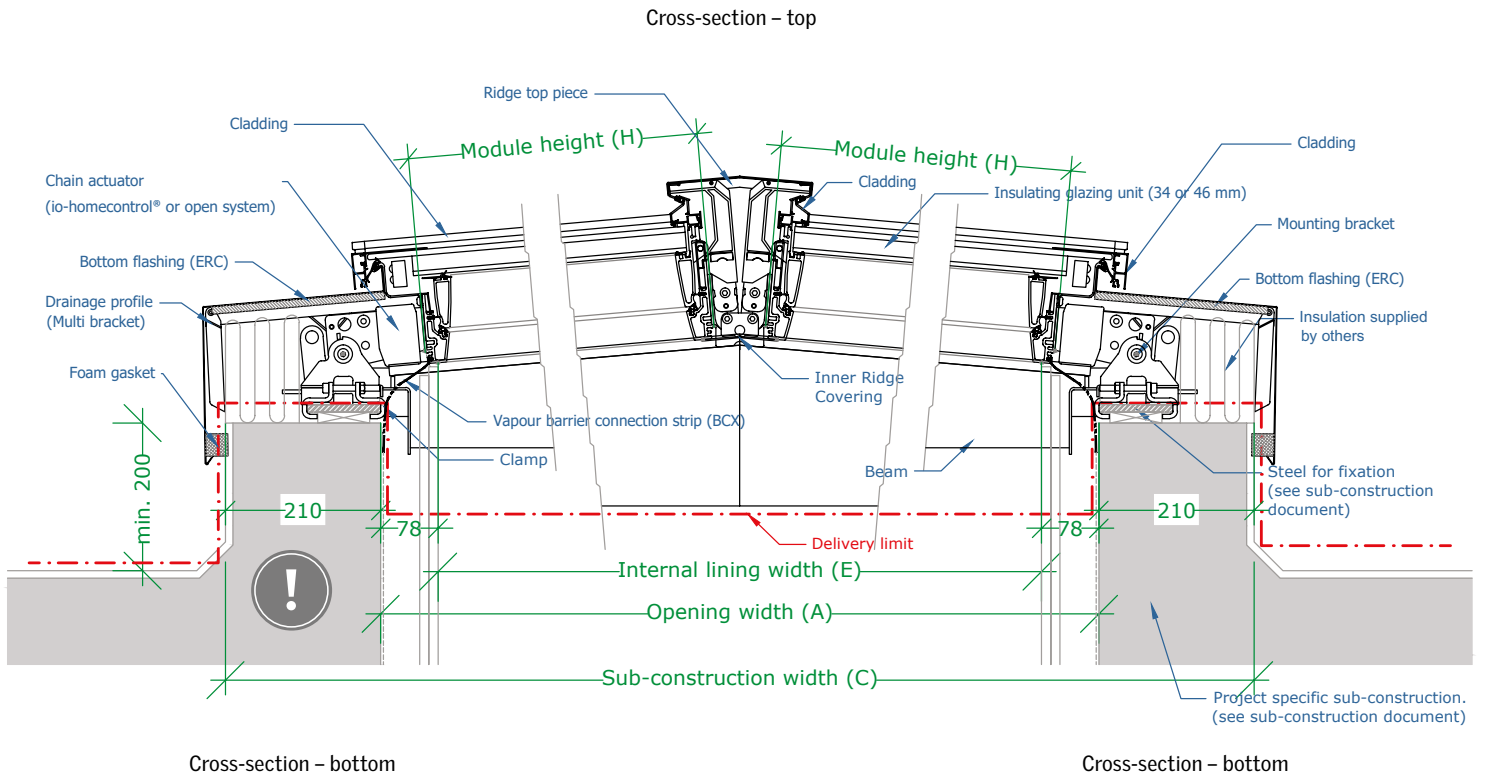

Longitudinal section

Please observe that a lateral slope on the modules is NOT possible, therefore top and bottom sub-construction must be horizontal.

Ridgelight at 5° with Beams (Parallel beam with curved profile)

Ridgelights at 5° pitch guarantee the illusion of a small glass roof with discreet transverse parallel supporting beams. The prefabricated VELUX beam supports the skylights and creates

the 5° pitch. The beams are mounted on a standard steel profile, 100 mm wide (not a VELUX component), on top of the sub-construction.

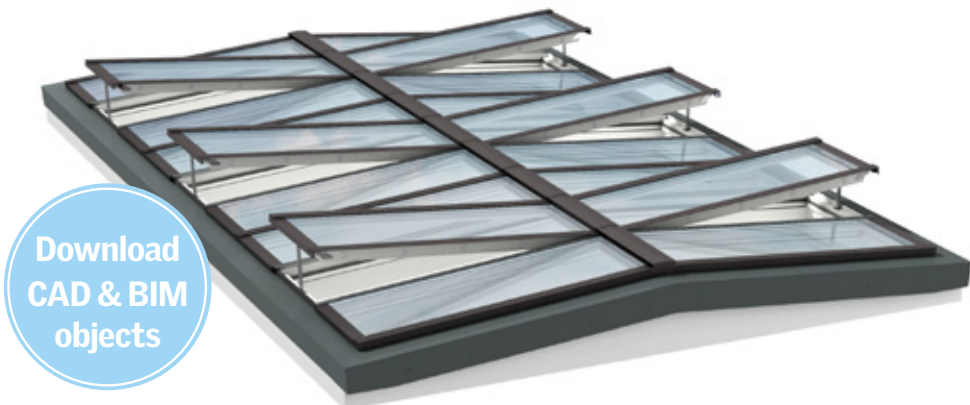

Download CAD & BIM objects

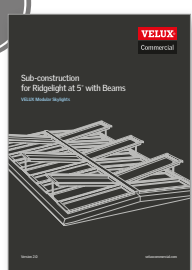

Sub-construction for Ridgelight at 5° with Beams at: veluxcommercial.com

Use the table to define module height (H) and/or installation pitch (α).

Example:
A = 4975 mm

Result:
α: H = 2400 mm at an installation pitch of 5°

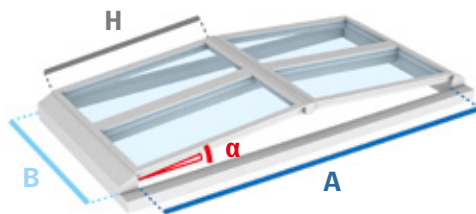

- H: Module height
- α: Installation pitch
- A: Opening width
- B: Opening length

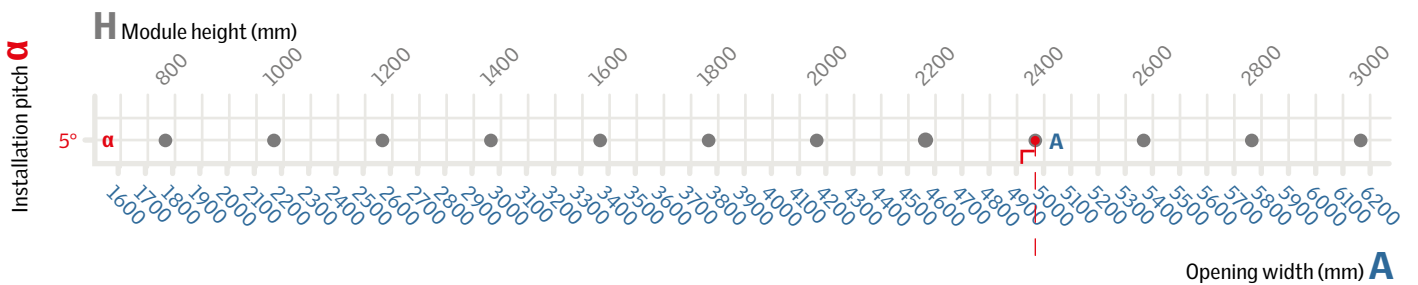

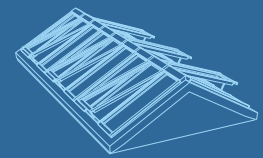

Sectional drawings

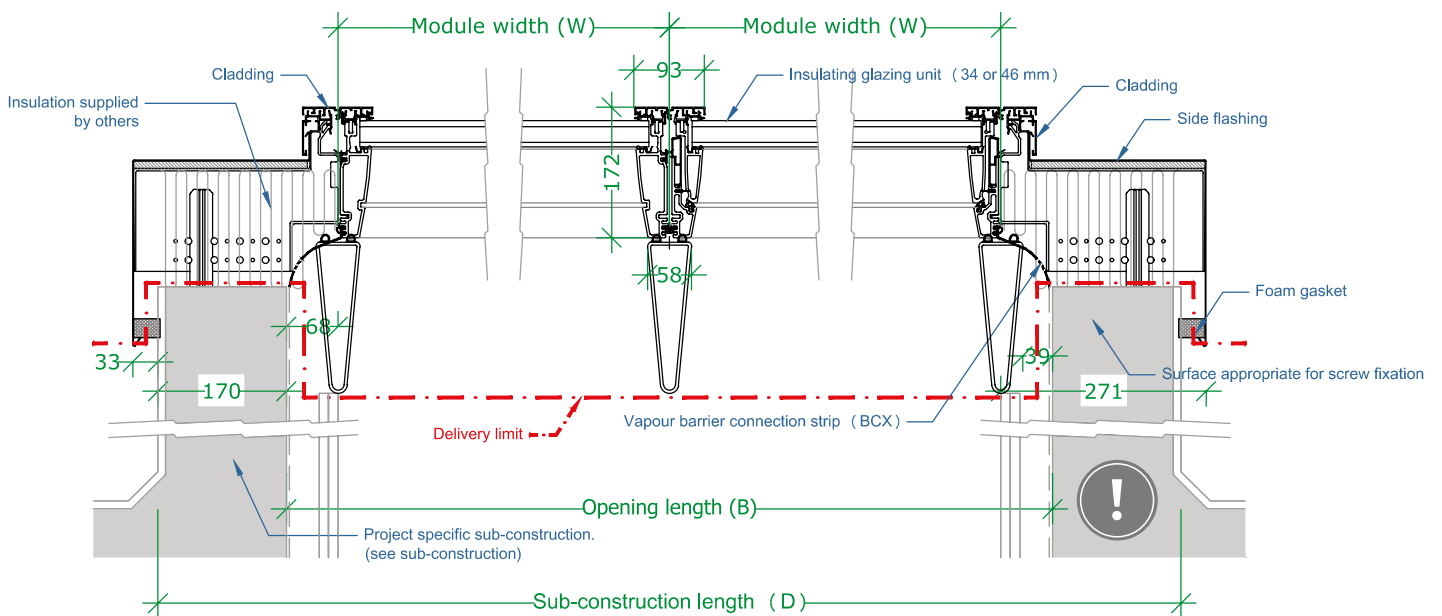
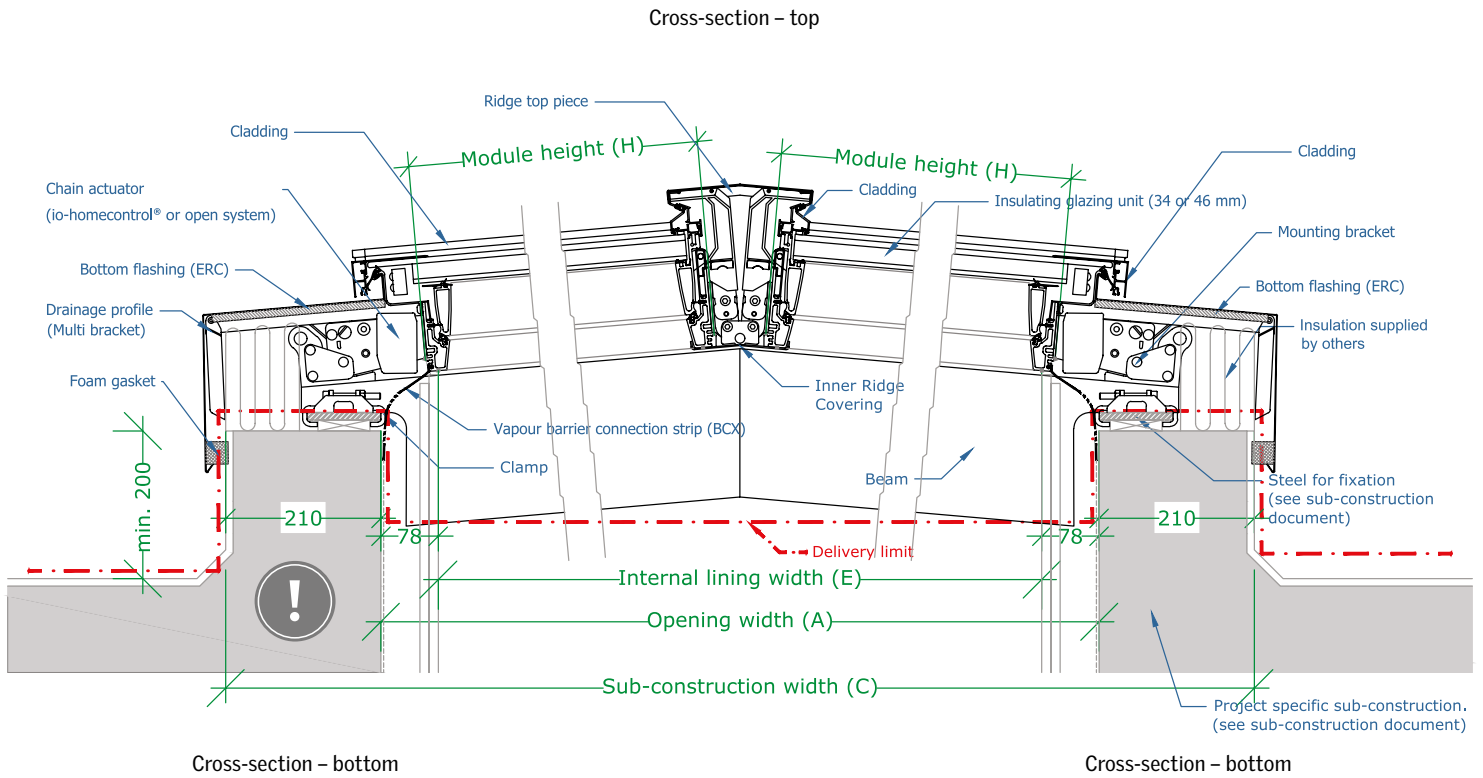

Longitudinal section

Please observe that a lateral slope on the modules is NOT possible, therefore top and bottom sub-construction must be horizontal.

Step Longlight 5-25°

Longlights in a Step solution are multiple rows of VELUX Modular Skylights installed close to each other using joint brackets and a clamping system that guarantee a fast and secure installation. The prefabricated flashing allows for configurations with a pitch of 5 to 25°.

The Longlight Step solution is mounted on 100 mm wide standard steel profiles (not a VELUX component).

Please note that the same installation pitch is required on all rows and that the maximum distance from the top of the lowest row of the modules to the top of total skylight is 15 metres.

The supporting beams between the rows are not included in the VELUX delivery. The support structure must be designed by a structural engineer.

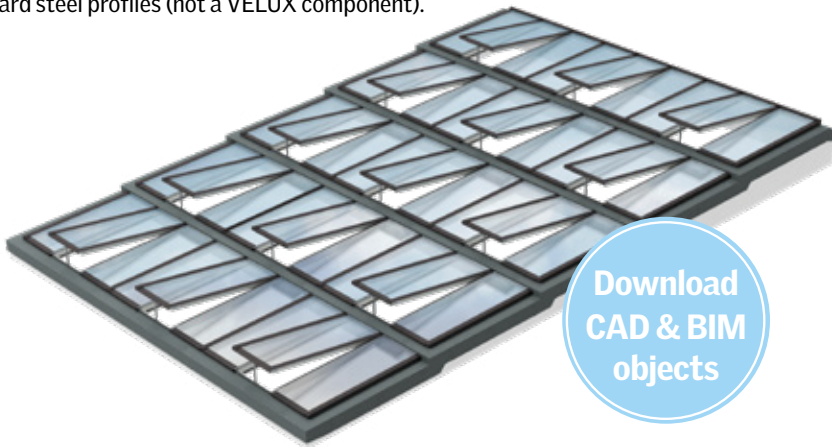

Download
CAD & BIM
objects

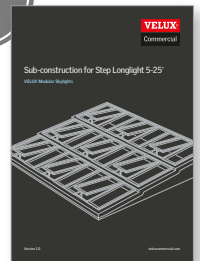

Sub-construction for
Step Longlight 5-25° at:
veluxcommercial.com

Use the table to define module height (H) and/or installation pitch (α).

Example:
A = 7000 mm

Result:
α1: H = 3 rows x 2200 mm at an installation pitch of 8.5°
or
α2: H = 3 rows x 2400 mm at an installation pitch of 23.5°

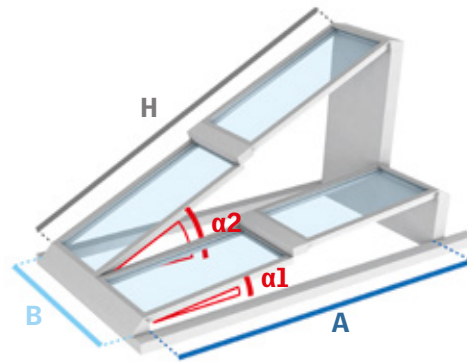

H: Module height
α: Installation pitch
A: Opening width
B: Opening length

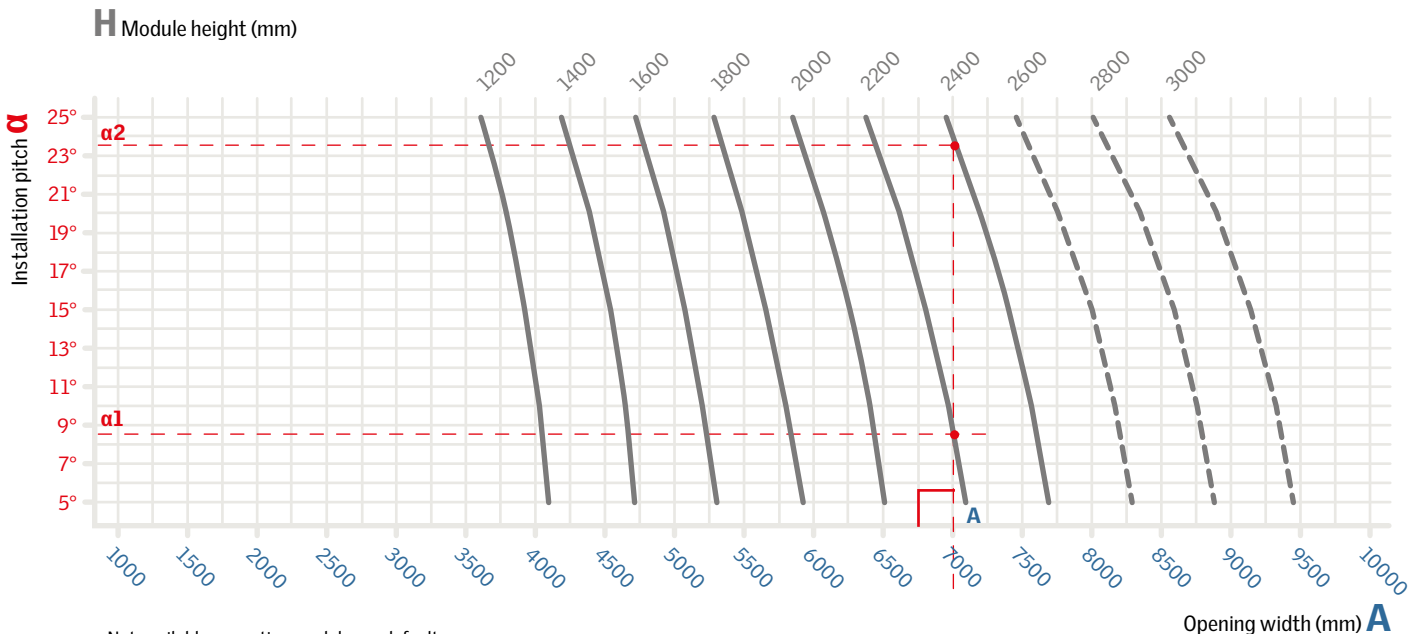

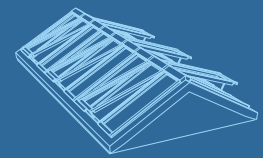

Sectional drawings

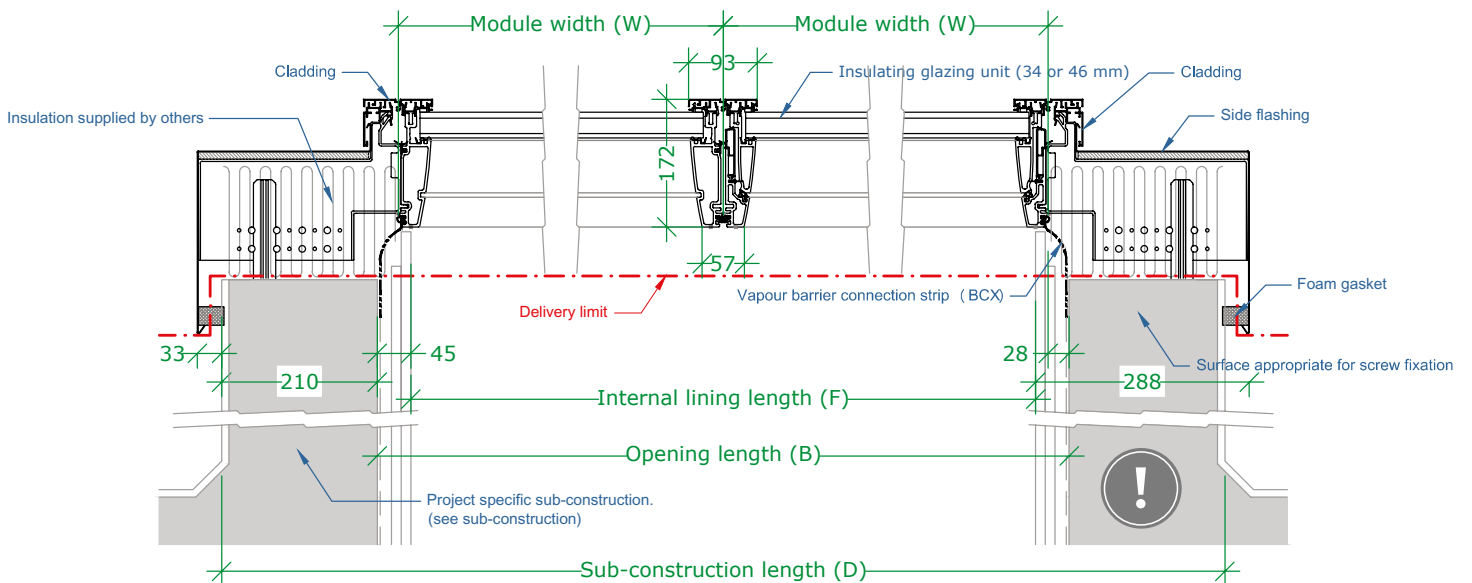
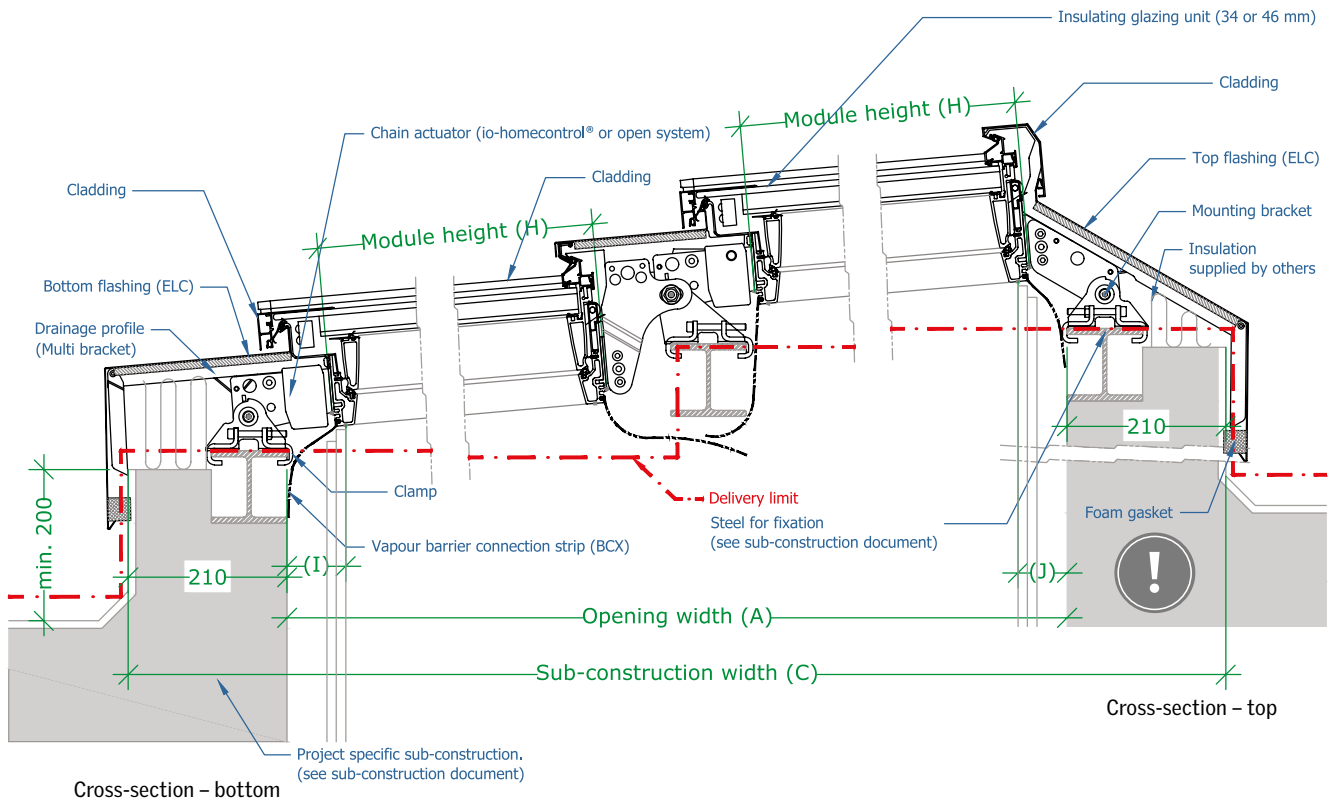

Please observe that a lateral slope on the modules is NOT possible, therefore top and bottom sub-construction must be horizontal.

Step Wall-mounted Longlight 5-25°

A Step solution consisting of multiple rows of VELUX Modular Skylights installed as Step Wall-mounted Longlight, where the modules are installed against a vertical wall in the top. The rows are installed close to each other using joint brackets and a clamping system that guarantee a fast and secure installation. The prefabricated flashings allows for configurations with a pitch of 5 to 25°.

The Wall-mounted Longlight Step solution is mounted on 100 mm wide standard steel profiles (not a VELUX component).

Please note that the same installation pitch is required on all rows and the maximum distance from the top of the vertical wall to the top of the lowest row of modules is 15 metres.

The supporting beams between the rows are not included in the VELUX delivery. The support structure must be designed by a structural engineer.

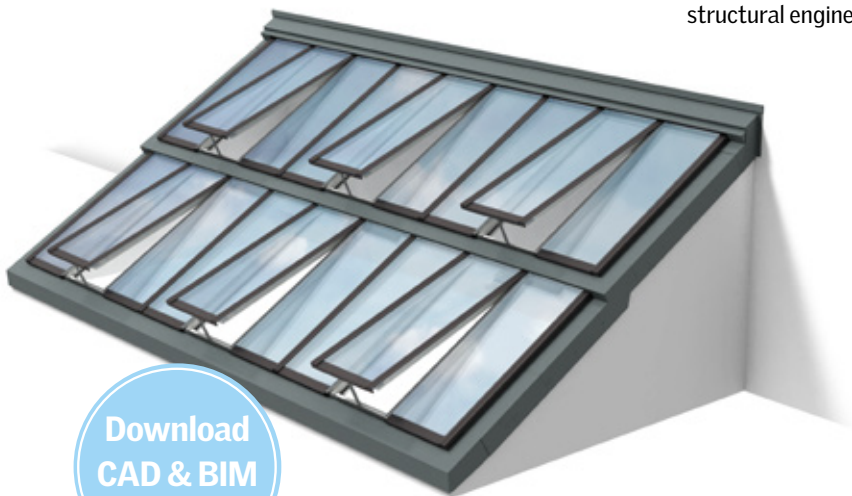

Download
CAD & BIM
objects



Sub-construction for
Step Wall-mounted Longlight 5-25°
veluxcommercial.com

Design your own grand ideas – Create a magnificent skylight

Ready to know if your ideas can become a reality?

Let us calculate your possibilities and give a price estimate for your chosen solution.

Contact your VELUX sales office for more details.



Sub-construction quality assurance (QA) document and specification document.

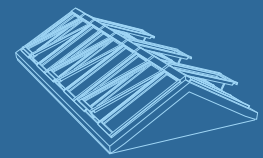

Sectional drawings

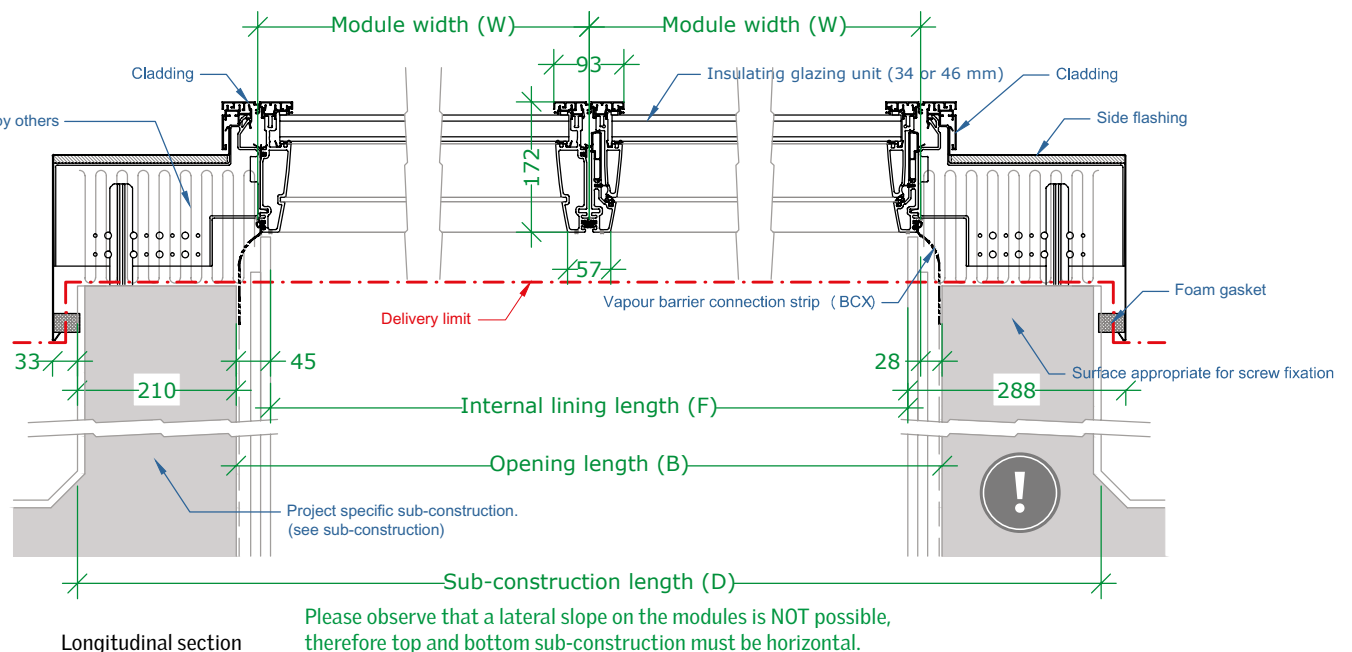
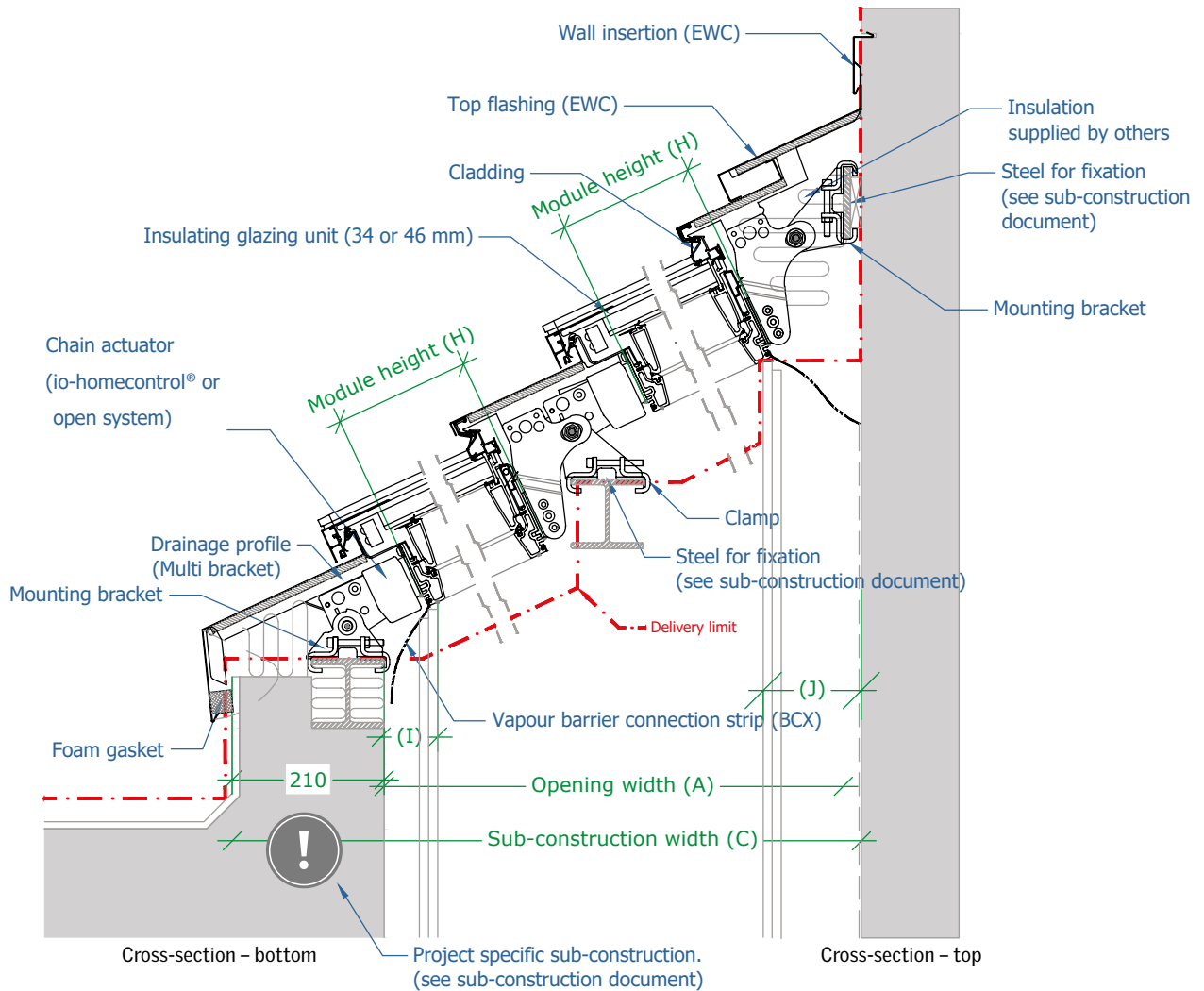

Step Ridgelight 25°

A Step Ridgelight 25° consist of a Ridgelight with one or more rows of modules below, on one or both sides, mounted close to each other using joint brackets and a clamping system that guarantee a fast and secure installation. The prefabricated flashing allows for configurations with a pitch of 25°

The Ridgelight Step solution is mounted on 100 mm wide standard steel profiles (not a VELUX component).

Please note that the same installation pitch is required on all rows and that the maximum distance from the top of the lowest row of the modules to the top of total skylight is 15 metres.

The supporting beams between the rows are not included in the VELUX delivery. The support structure must be designed by a structural engineer.

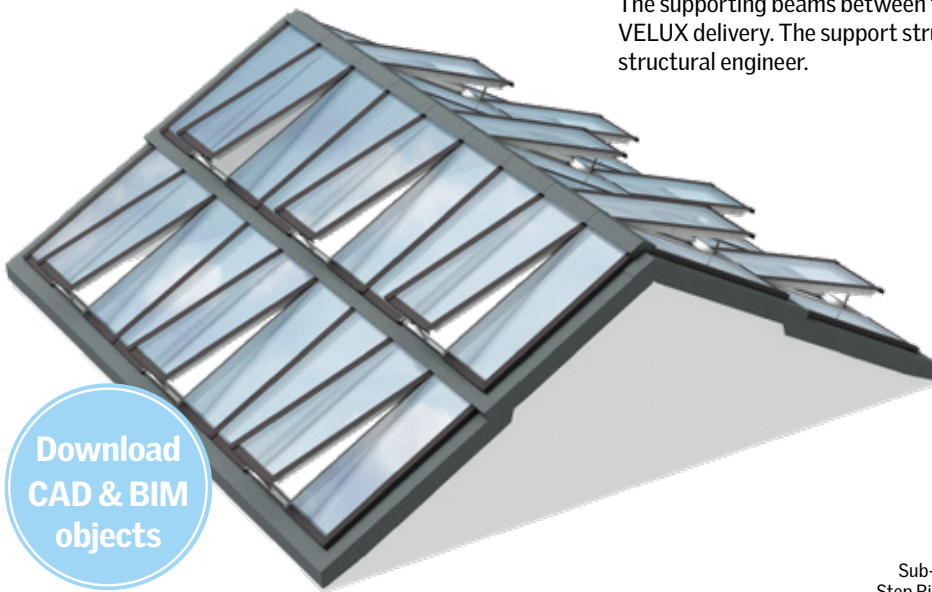

Sub-construction for Step Ridgelight at 5° at: veluxcommercial.com

Design your own grand ideas – Create a magnificent skylight

Ready to know if your ideas can become a reality?

Let us calculate your possibilities and give a price estimate for your chosen solution.

Contact your VELUX sales office for more details.



Sub-construction quality assurance (QA) document and specification document.

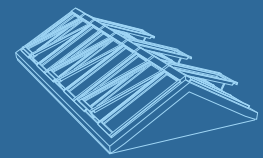

Sectional drawings

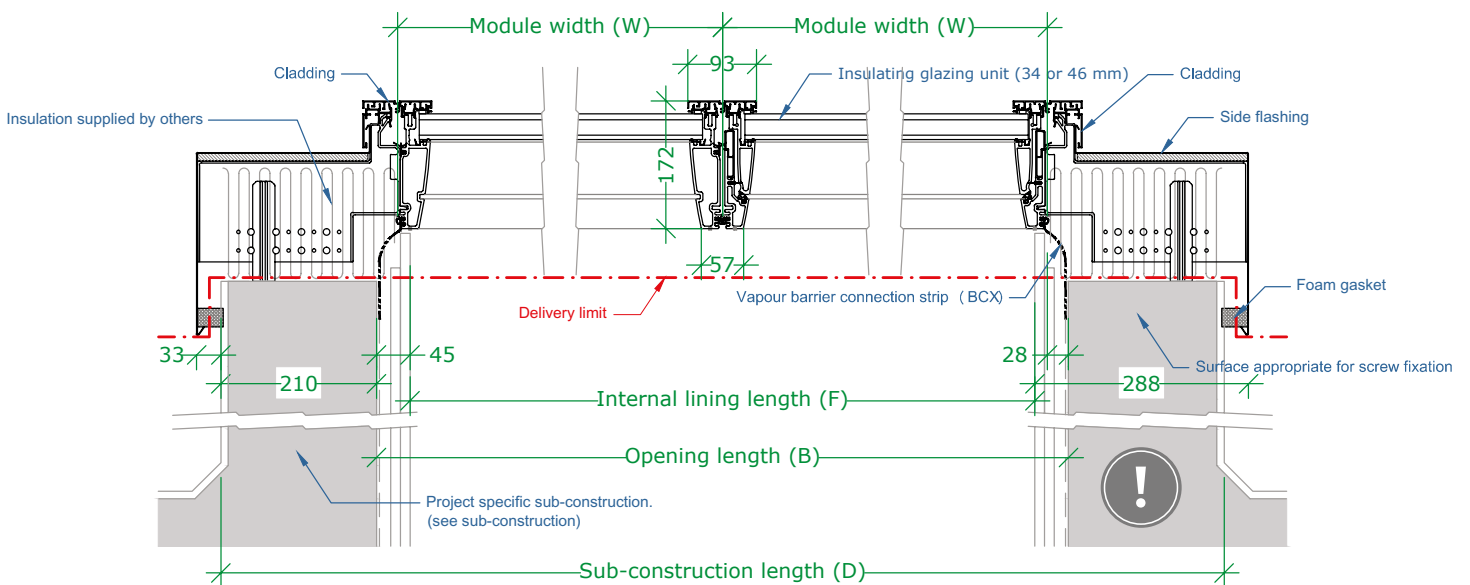
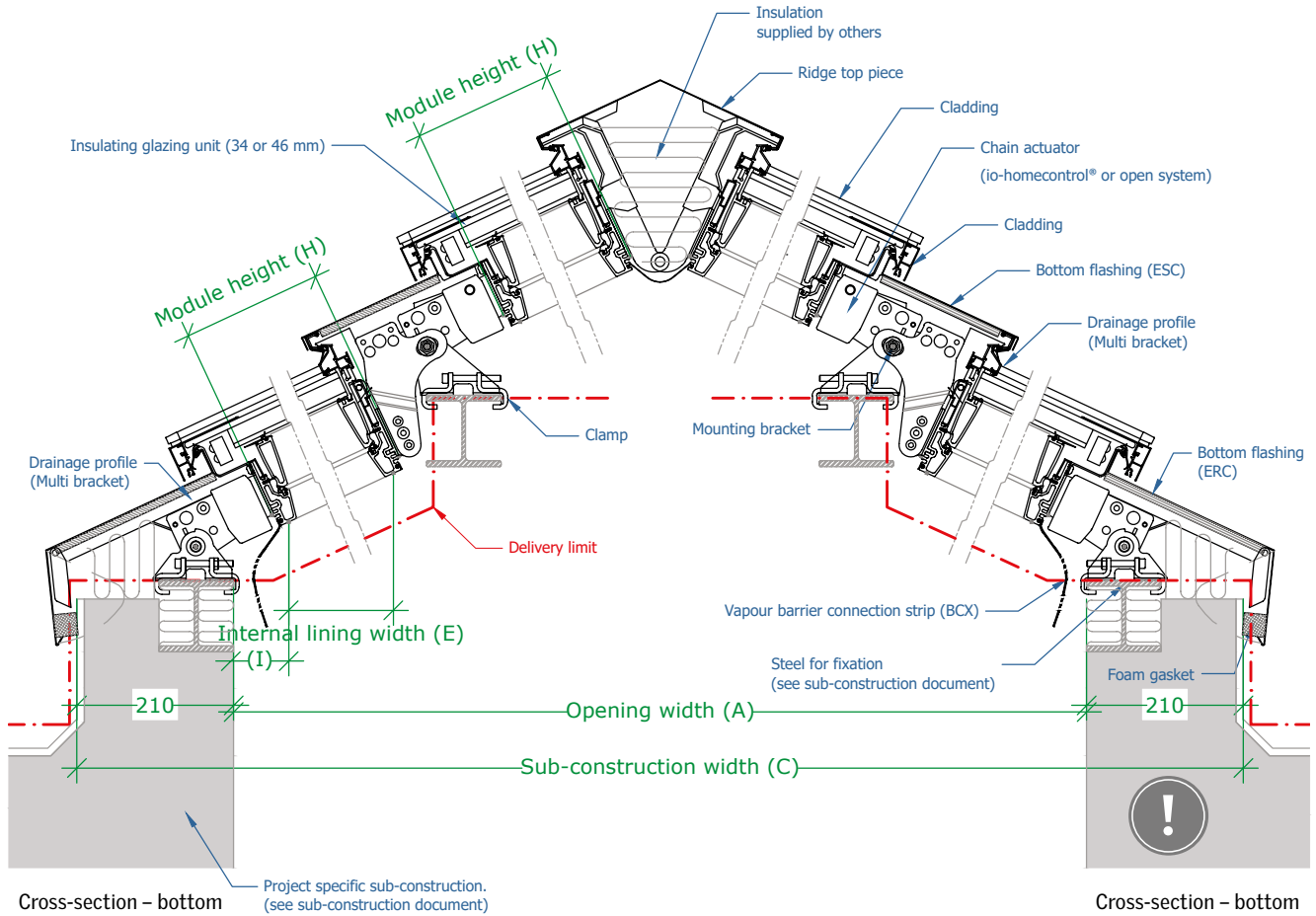

Please observe that a lateral slope on the modules is NOT possible, therefore top and bottom sub-construction must be horizontal.

Step Ridgelight 5-25° on Girder

A Step Ridgelight 5-25° on Girder, consist of a Ridgelight with one or more rows of modules below, on one or both sides, mounted close to each other using joint brackets and a clamping system that guarantee a fast and secure installation. The prefabricated flashing allows for configurations with a pitch of 5° or 25°.

The Step Ridgelight 5-25° on Girder solutions are mounted on 100 mm wide standard steel profiles (not a VELUX component).

Please note that the same installation pitch is required on all rows on the same side, however different installation pitches is possible on each side of the girder.

The maximum distance from the top of the lowest row of the modules to the top of total skylight is 15 metres.

The supporting beams between the rows are not included in the VELUX delivery. The support structure must be designed by a structural engineer.

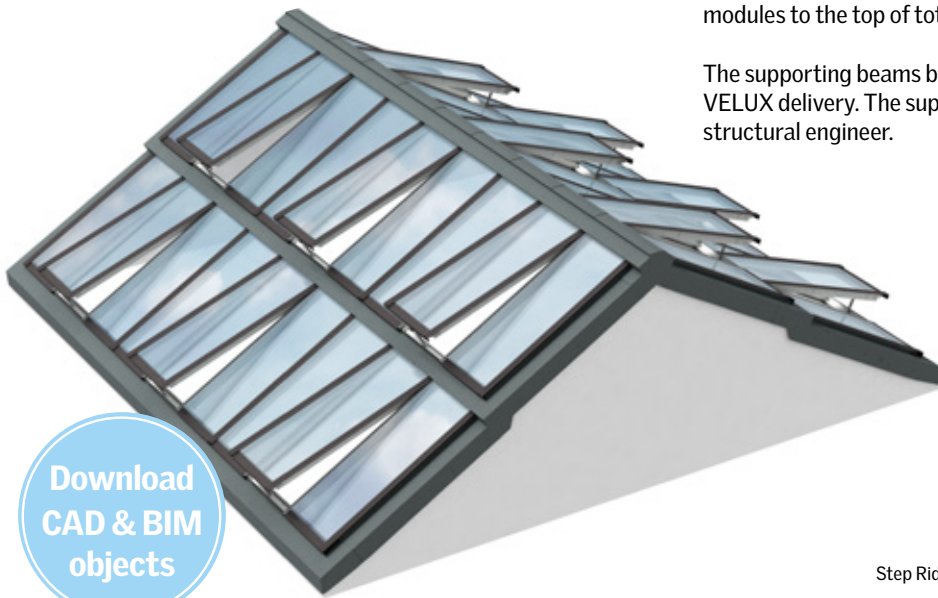

Download
CAD & BIM
objects

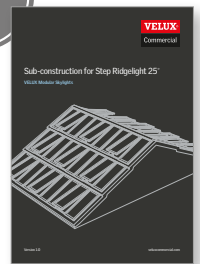

Sub-construction for
Step Ridgelight 5-25° on Girder at:
veluxcommercial.com

Design your own grand ideas – Create a magnificent skylight

Ready to know if your ideas can become a reality?

Let us calculate your possibilities and give a price estimate for your chosen solution.

Contact your VELUX sales office for more details.



Sub-construction quality assurance (QA) document and specification document.

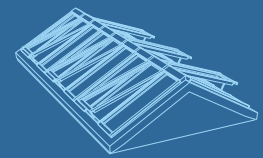

Sectional drawings

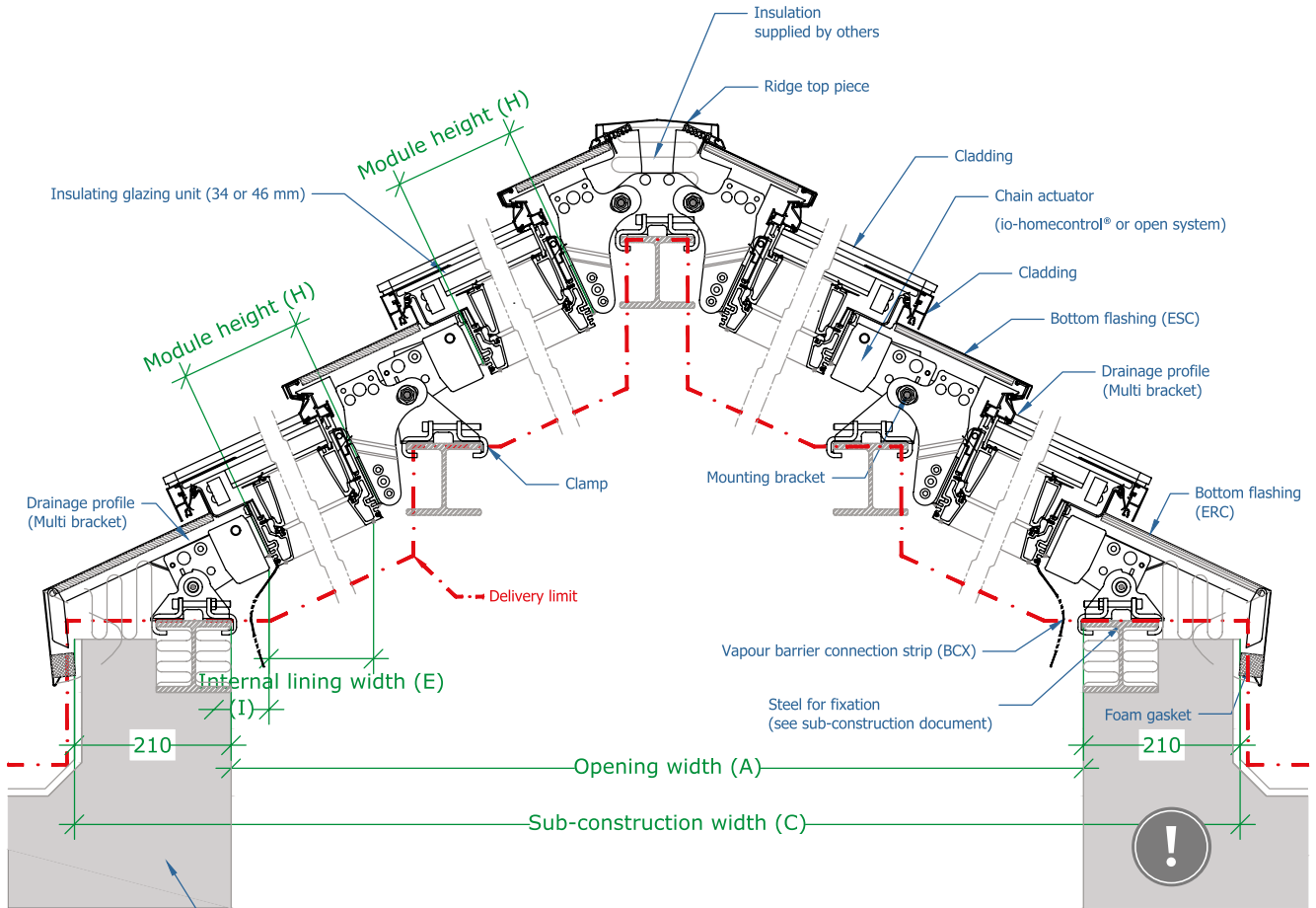

Cross-section - bottom

Cross-section - bottom

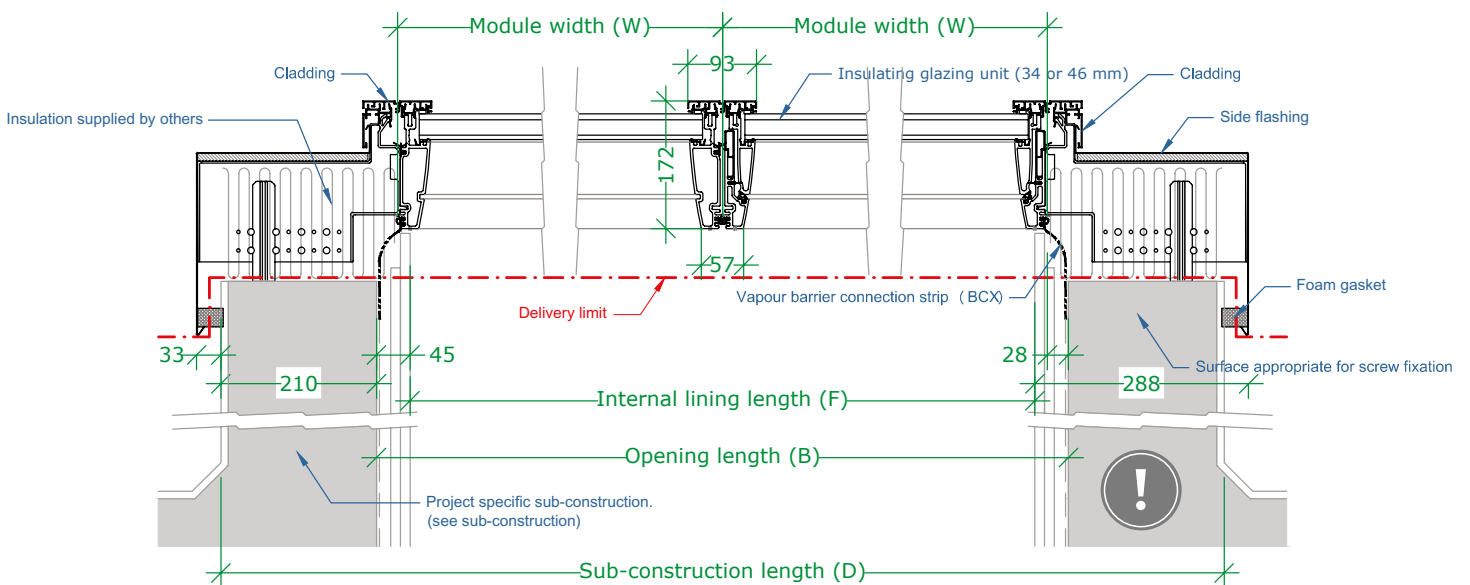

Longitudinal section

Please observe that a lateral slope on the modules is NOT possible, therefore top and bottom sub-construction must be horizontal.

Atrium Longlight

An Atrium solution consists of several Longlights attached to each other in the sub-construction. A drainage gutter separates each assembly.

The supporting beams are not included in the VELUX delivery. The support structure is part of the primary structure of the building and will have to be designed by a structural engineer.

The distance between the skylights depends on thickness of insulation, width of drainage gutter and pitch of skylights. The shown example of an Atrium is designed with 100 mm insulation and a 400 mm wide drainage gutter in a 5° pitch, resulting in a distance between skylights of 820 mm.



Download
CAD & BIM
objects

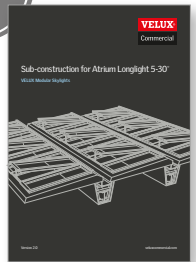

Sub-construction
for Atrium Longlight at:
veluxcommercial.com

Use the table to define module height (H) and/or installation pitch (α).

Example:
A = 2870 mm

Result:
α1: H = 2800 mm at an installation pitch of 10°
or
α2: H = 3000 mm at an installation pitch of 23°

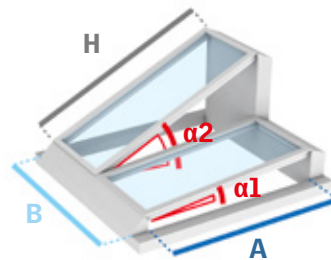

H: Module height
α: Installation pitch
A: Opening width
B: Opening length

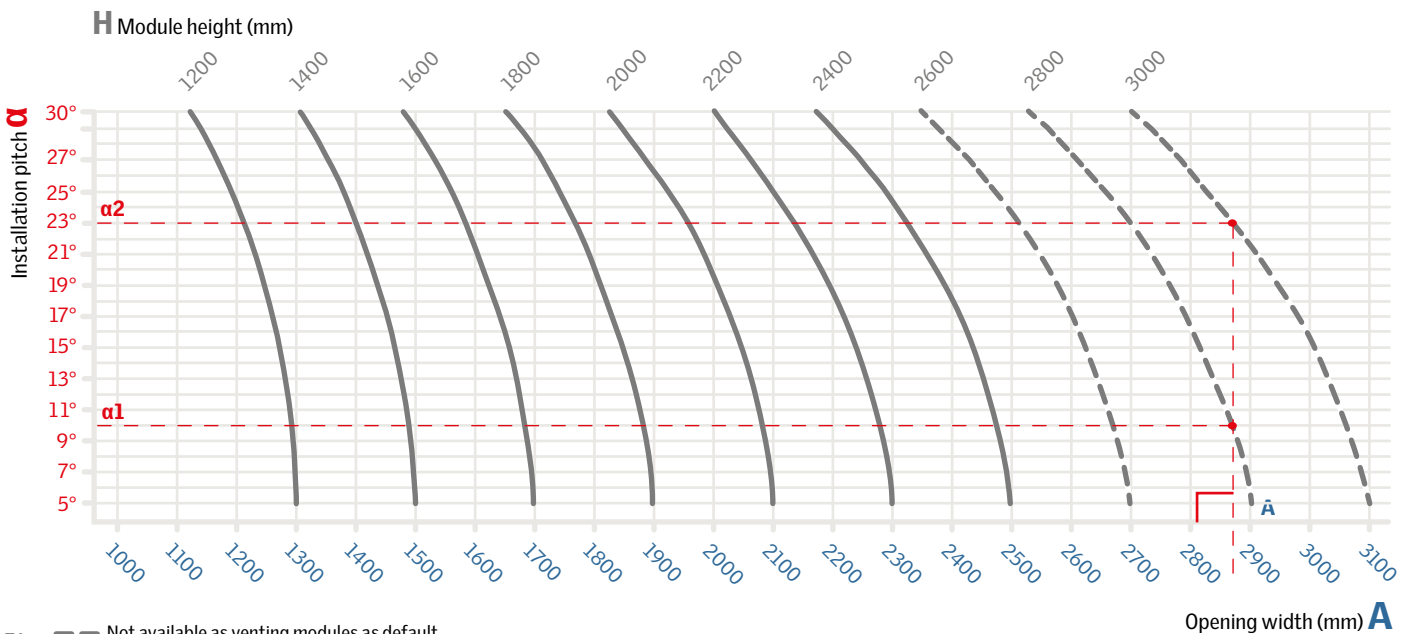

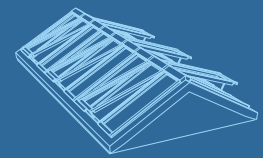

Sectional drawings

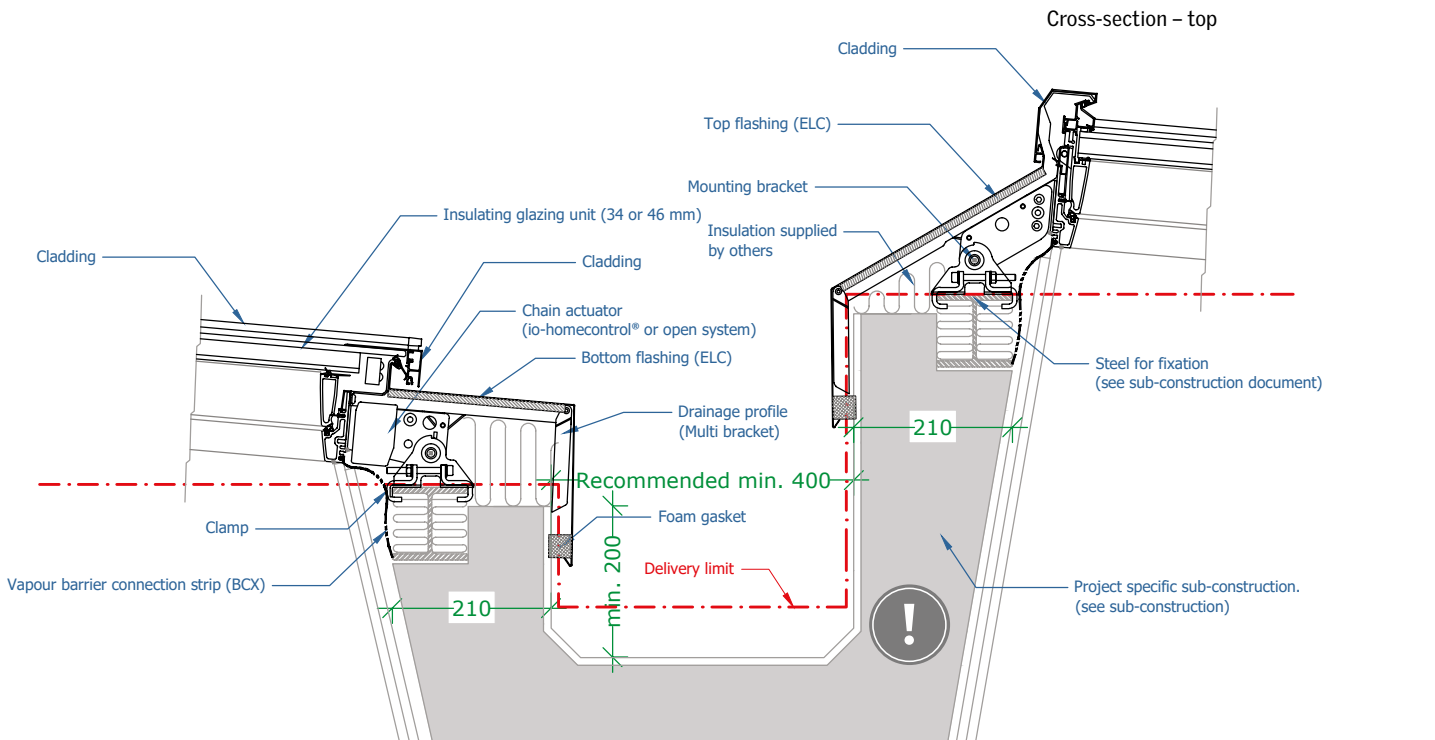

Cross-section - bottom

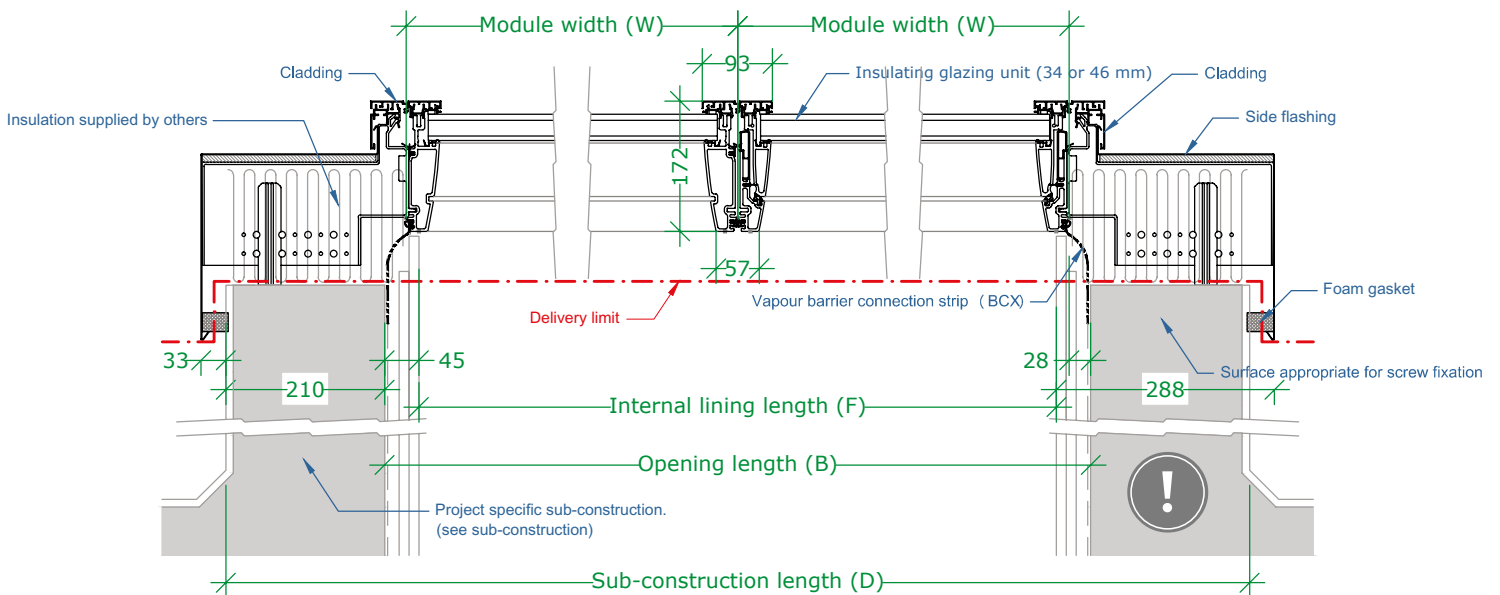

Longitudinal section

Please observe that a lateral slope on the modules is NOT possible, therefore top and bottom sub-construction must be horizontal.

Atrium Ridgelight & Atrium Ridgelight at 5° with Beams

An Atrium Ridgelight solution consists of several Ridgelights attached to each other in the sub-construction. A drainage gutter separates each strip.

The supporting steel beams are not included in the VELUX delivery. The support structure is part of the primary structure of a building and must be designed by a structural engineer.

The distance between the skylights depends on thickness of insulation, width of drainage gutter and pitch of skylights. The shown example of an Atrium is designed with 100 mm insulation and a 400 mm wide drainage gutter in a 5° pitch, resulting in a distance between the skylights of 820 mm.

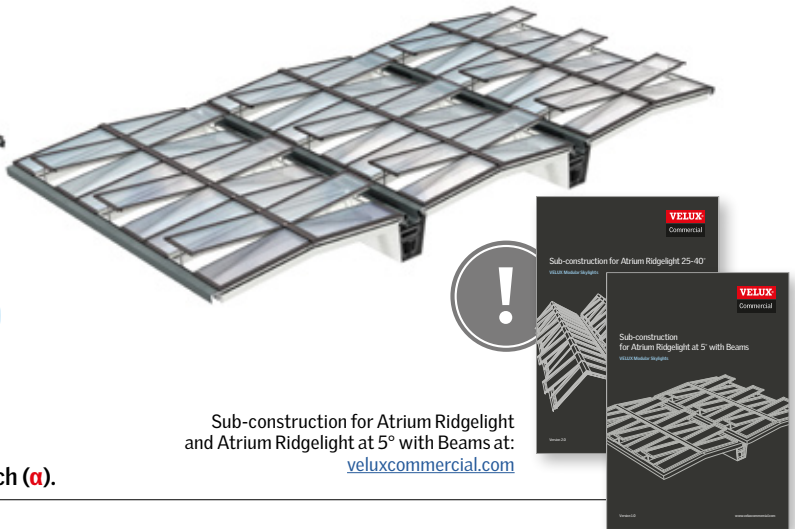
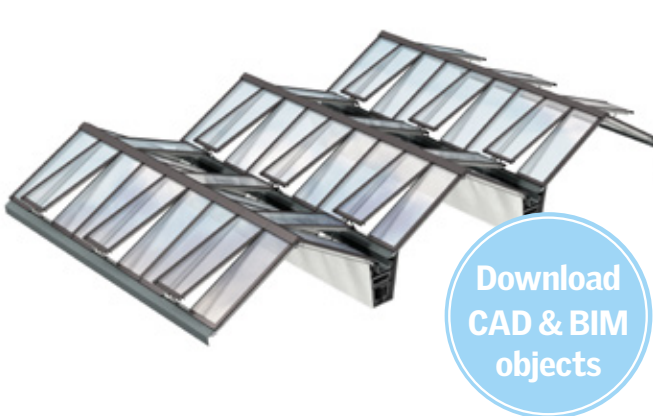

Sub-construction for Atrium Ridgelight and Atrium Ridgelight at 5° with Beams at: veluxcommercial.com

Use the table to define module height (H) and/or installation pitch (α).

Example:
 $A = 3775 \text{ mm}$

Result:
 $\alpha 1$: $H = 1800 \text{ mm}$ at an installation pitch of 5°
 $\alpha 2$: $H = 2000 \text{ mm}$ at an installation pitch of 26°
 or
 $\alpha 3$: $H = 2200 \text{ mm}$ at an installation pitch of 35.5°

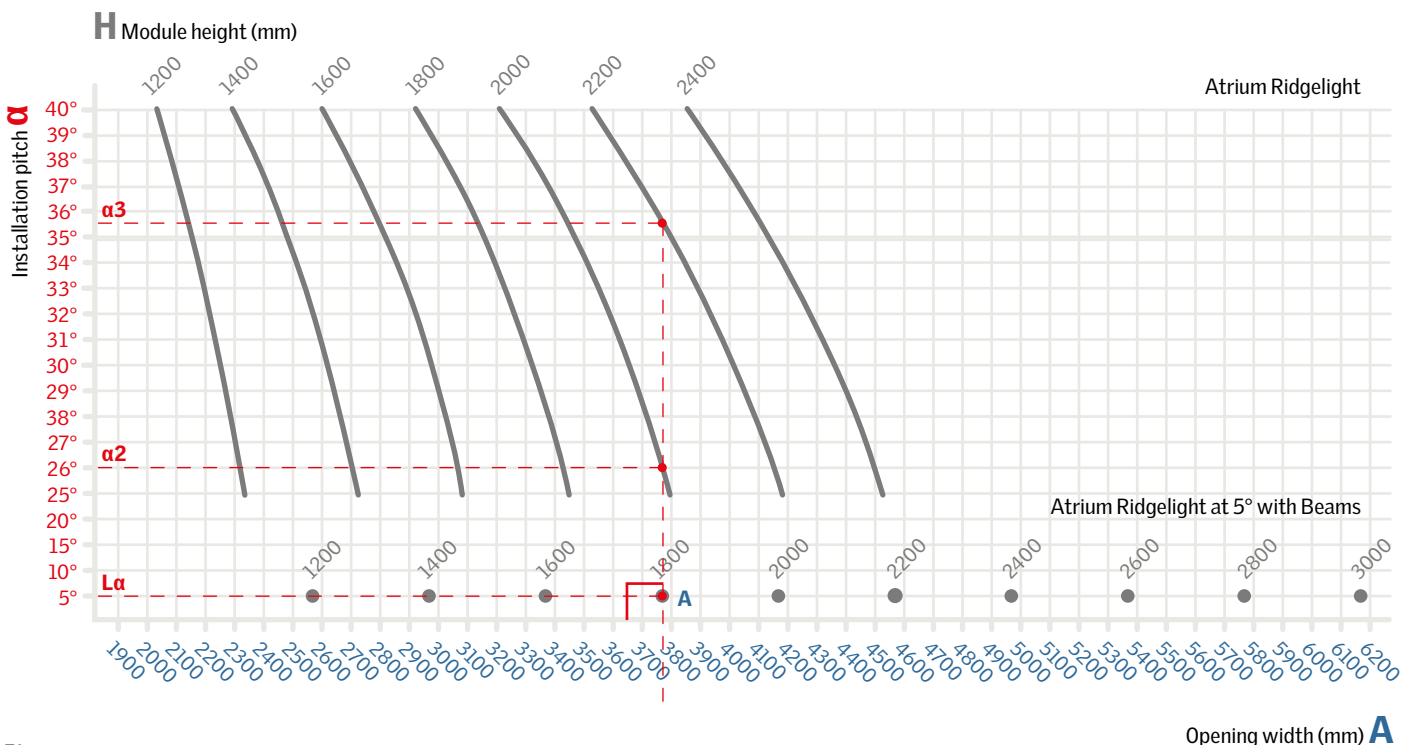

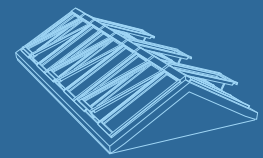

Sectional drawings

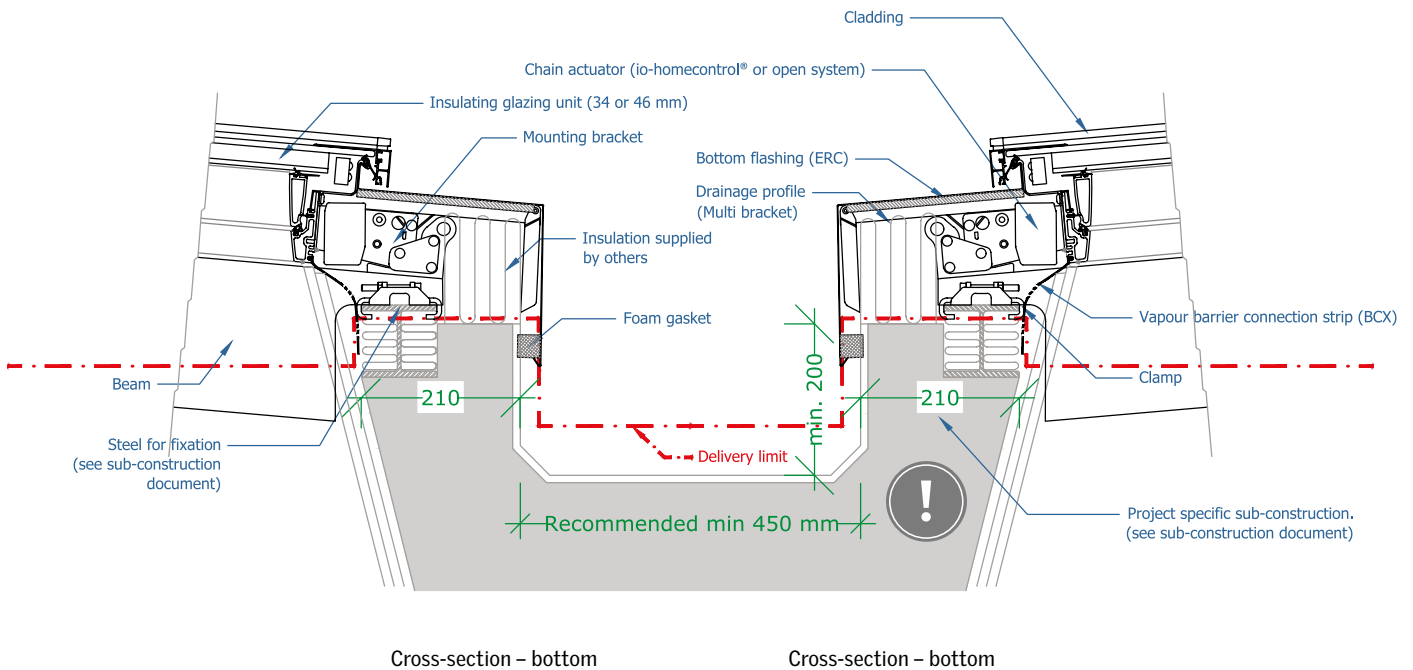
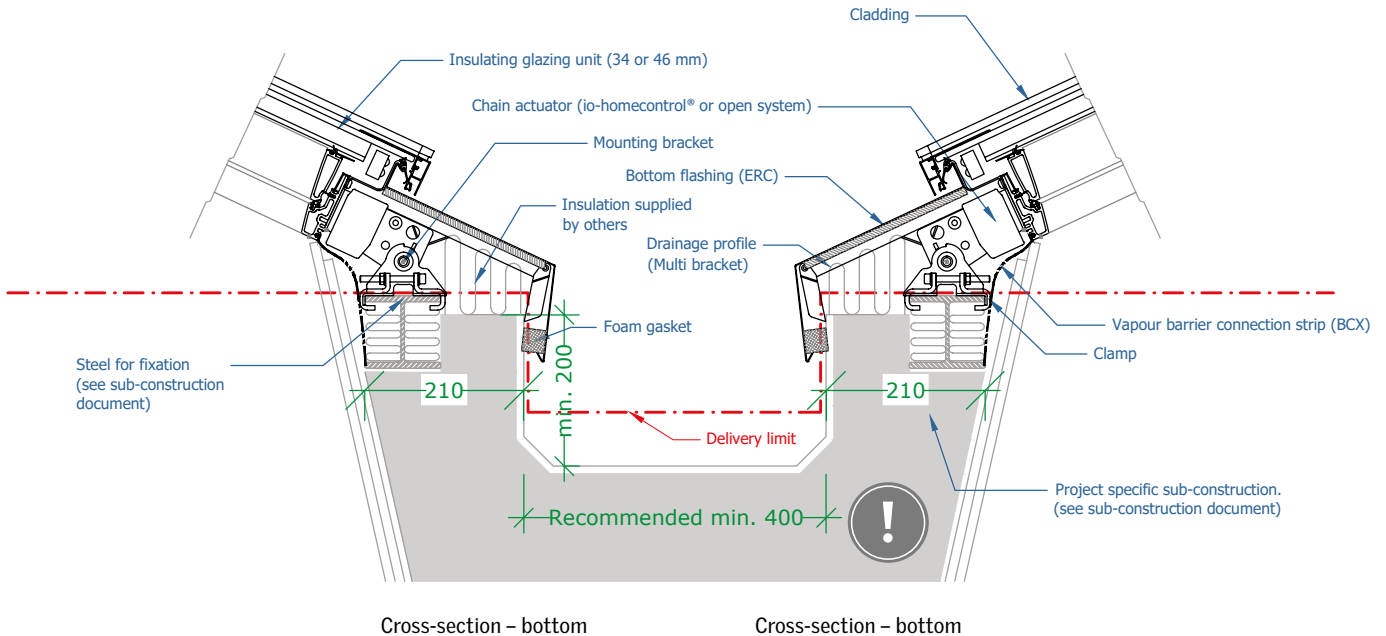

Please observe that a lateral slope on the modules is NOT possible, therefore top and bottom sub-construction must be horizontal.

* For longitudinal section drawings for Atrium Ridgelight and Atrium Ridgelight 5°, see pages 61, 63 and 65..

Class 1

15

12.5

10

Class 2

6.75

Product Data

5.0

Class 3

2.5

2.2

2.0

Skylight module



Essential characteristic performances for CE-marked skylight modules (EN 14351-1)

H-C -----		
Essential characteristics	Performance	
Resistance to wind load	Class C5 ¹⁾	
Resistance to snow load	See glazing variant construction	
Reaction to Fire*	Class B, s1-d0 - B, s1-d2 **	
External fire performance***	B _{ROOF} (t1) ; B _{ROOF} (t4)	
Watertightness****	E1200	
Impact resistance	NPD	
Load-bearing capacity of safety devices	NPD ²⁾	
Acoustic performance	34 (-1; -5) - 38 (-1; -4) dB ³⁾	
Thermal transmittance	Double glazing 1.3-1.5 W/m ² K ³⁾	Triple glazing: 0.86-1.1 W/m ² K ³⁾
Solar factor	0.62 - 0.14 ³⁾	
Light transmittance	0.80 - 0.16 ³⁾	
Air permeability*****	Class 4 ⁴⁾	

¹⁾ For sizes up to 2400 mm height, except HVC 100240 with glazing variants 10L and 11L, which have Class B4. For skylight height > 2400 mm: NPD.

²⁾ No safety device on VELUX Modular Skylights

³⁾ For specific types and sizes, see the table with glazing variants on page 100

⁴⁾ Except HVC 090220, HVC 090240, HVC 100220 and HVC 100240 with glazing variants 10L and 11L. For these classification is Class 3

Note:

The performances in the above table and the attached notes to these are valid for the size grid shown on page 9.

For sizes outside the size grid, altering performances may apply. The changes in performances depend on the actual size and are therefore to be identified individually.

* For explanation of test method and results, please refer to section on Reaction to Fire

** Variants with inner pane of 55.2 lamination have a sub-class s1,d0

Variants with inner pane of 33.2 and 44.2 lamination have a sub-class s1,d2

*** For explanation of test method and results, please refer to section on External fire performance

**** For explanation of test method and results, please refer to section on Watertightness

***** For explanation of test method and results, please refer to section on Air Permeability

Performance of fire resistant skylight modules (EN 13501-2 + A1)

HFS -----	
Essential characteristics	Performance
Resistance to Fire HFS (fixed)	REI30

Note:

The fixed fire resistant modules HFS are tested in accordance with EN 1365-2. The classifications are expressed in accordance with EN 13501-2 + A1. The tests are carried out without roller blinds by default. If a customer wishes to install roller blinds on the fire resistant modules subsequently, the VELUX Group recommends that the customer obtains written approval from the local fire authorities. HFS has an intumescent seal strip between the fire resistant glazing and frame and between the modules. The strip expands when exposed to heat in order to contain the fire for a longer time. For more information on the performance characteristics of fire resistant skylight modules, see pages 100 and 117.

- When installing the fixed fire resistant modules HFS, the special HFS installation instructions regarding sealant and protection of the lining / bracket area must be followed. The obtained REI 30 classification of HFS is only valid if the instructions are strictly followed.
- It is the responsibility of the customer that the sub-construction meets the required fire resistance performance of the roof.
- When installing the fixed fire resistant modules HFS in combination with a Step solution, it is the responsibility of the user that the supporting structures between module lines are also designed to meet the fire resistance requirements of the roof construction, therefore not causing weak chain in the performance of the HFS module applications.

Product Name	Model	Material	Weight
Product Code	Accessories	Dimensions	Lead Time
Manufacturer	Country of Origin	Warranty	Notes

Skylight module

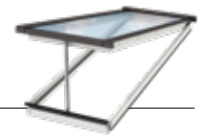

Essential characteristic performances for CE-marked smoke ventilation skylight modules (EN 12101-2)

H-C -----AB

Essential characteristics	Performance
Nominal activation system/sensitivity	passed
Response delay (response time)	< 60 s
Operational reliability	Re 1000 + 10 000
Aerodynamic free area (A _a) [m ²]	See ventilation tables on pages 92, 93, 96 and 97
Resistance to heat	B300
Mechanical stability	passed
Opening under load	See tables on the next four pages (Opening under load)
Low ambient temperature	T(-15)
Stability under wind load	WL 3000
Resistance to wind-induced vibration (where included)	passed
Reaction to Fire*	Class B, s1-d0 - B, s1-d2 **

* For explanation of test method and results, please refer to section of Reaction to Fire

** Variants with inner pane of 55.2 lamination have a sub-class s1,d0

Variants with inner pane of 33.2 and 44.2 lamination have a sub-class s1,d2

Skylight module opening under load (Snow Load)

Smoke venting skylight modules can in production be configured with 5 different motor force levels enabling variable snow load performance (Opening under load) and electric current requirement (Amp requirement) per size and glazing thickness.

Choose motor force programme according to your project specific snow load need. The provided characteristics for Opening under load and related current consumptions on pages 82-85 are tested and valid for 24 V DC nominal voltage.

See tables on the next four pages.

Skylight module

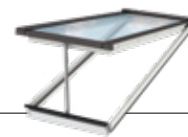

Opening under load

Glazing unit construction with a total glass thickness of 12 mm																	
Product ID		HVC 067---			HVC 075---			HVC 080---			HVC 090---			HVC 100---			
Height	Size [mm]	Width	675			750			800			900			1000		
	Motor program	Chain stroke [mm]	Electric current requirement [AMP]	Snow Load [Pa]	Chain stroke [mm]	Electric current requirement [AMP]	Snow Load [Pa]	Chain stroke [mm]	Electric current requirement [AMP]	Snow Load [Pa]	Chain stroke [mm]	Electric current requirement [AMP]	Snow Load [Pa]	Chain stroke [mm]	Electric current requirement [AMP]	Snow Load [Pa]	
HVC ---080	800	N0800	353	2.5	2023	353	2.5	1808	353	2.5	1685	353	2.5	1476	353	2.5	1305
		N1000		3.0	2643		3.0	2373		3.0	2218		3.0	1955		3.0	1740
		N1100		3.0	2952		3.0	2655		3.0	2484		3.0	2194		3.0	1958
		N1200		3.0	3262		3.0	2937		3.0	2751		3.0	2434		3.0	2175
		N1300		3.0	3572		3.0	3219		3.0	3017		3.0	2674		3.0	2393
HVC ---100	1000	N0800	410	2.5	1573	410	2.5	1400	439	2.5	1300	439	2.5	1132	439	2.5	994
		N1000		3.0	2073		3.0	1856		3.0	1731		3.0	1519		3.0	1346
		N1100		3.0	2323		3.5	2084		3.5	1946		3.5	1712		3.5	1521
		N1200		3.0	2574		3.5	2311		3.5	2161		3.5	1906		3.5	1697
		N1300		4.0	2824		3.5	2539		3.5	2376		3.5	2099		3.5	1873
HVC ---120	1200	N0800	410	2.5	1268	410	3.0	1123	526	3.0	1040	526	3.0	899	526	3.0	783
		N1000		3.0	1687		3.0	1505		3.5	1401		3.5	1223		3.5	1078
		N1100		3.0	1897		3.5	1696		3.5	1581		3.5	1386		3.5	1226
		N1200		3.0	2107		3.5	1888		4.0	1762		4.0	1548		4.0	1373
		N1300		4.0	2317		4.0	2079		4.0	1942		4.0	1710		4.0	1521
HVC ---140	1400	N0800	410	2.5	1047	410	3.0	923	530	3.0	851	610	3.5	730	610	3.5	631
		N1000		3.0	1409		3.0	1252		3.5	1162		4.0	1010		4.0	885
		N1100		3.0	1589		3.5	1417		3.5	1318		4.0	1150		4.0	1012
		N1200		3.0	1770		3.5	1581		4.0	1473		4.0	1289		4.0	1139
		N1300		4.0	1951		4.0	1746		4.0	1629		4.0	1429		4.0	1266
HVC ---160	1600	N0800	410	2.5	880	410	3.0	771	530	3.0	709	610	3.5	603	700	3.5	516
		N1000		3.0	1198		3.0	1061		3.5	982		4.0	848		4.0	739
		N1100		3.0	1357		3.5	1205		3.5	1119		4.0	971		4.5	851
		N1200		3.0	1515		3.5	1350		4.0	1255		4.0	1094		4.5	962
		N1300		4.0	1674		4.0	1495		4.0	1392		4.0	1217		5.0	1074
HVC ---180	1800	N0800	410	2.5	750	410	3.0	653	530	3.0	598	610	3.5	503	700	3.5	426
		N1000		3.0	1033		3.0	911		3.5	841		4.0	722		4.0	625
		N1100		3.0	1174		3.5	1040		3.5	963		4.0	832		4.5	724
		N1200		3.0	1316		3.5	1169		4.0	1084		4.0	941		4.5	824
		N1300		4.0	1457		4.0	1298		4.0	1206		4.0	1050		5.0	923
HVC ---200	2000	N0800	410	2.5	645	410	3.0	558	530	3.0	508	610	3.5	423	700	3.5	354
		N1000		3.0	900		3.0	790		3.5	727		4.0	621		4.0	533
		N1100		3.0	1028		3.5	907		3.5	837		4.0	719		4.5	623
		N1200		3.0	1156		3.5	1023		4.0	947		4.0	818		4.5	712
		N1300		4.0	1283		4.0	1139		4.0	1057		4.0	917		5.0	802
HVC ---220	2200	N0800	410	2.5	559	410	3.0	480	530	3.0	434	610	3.5	357	700	3.5	294
		N1000		3.0	791		3.0	692		3.5	634		4.0	537		4.0	458
		N1100		3.0	908		3.5	797		3.5	734		4.0	627		4.5	539
		N1200		3.0	1024		3.5	903		4.0	834		4.0	717		4.5	621
		N1300		4.0	1140		4.0	1009		4.0	934		4.0	807		5.0	703
HVC ---240	2400	N800	410	2.5	487	410	3.0	414	530	3.0	373	610	3.5	302	700	3.5	245
		N1000		3.0	700		3.0	609		3.5	556		4.0	467		4.0	395
		N1100		3.0	807		3.5	706		3.5	648		4.0	550		4.5	469
		N1200		3.0	914		3.5	803		4.0	740		4.0	632		4.5	544
		N1300		4.0	1020		4.0	900		4.0	832		4.0	715		5.0	619

The tables illustrate the performance for modules opening under load in accordance with EN 12101-2. The provided performance is NOT equal to structural load bearing capacity of an actual application. The design of a roof light must therefore be dimensioned to fit the specific building project, local architectural style and practice.

Standard size.
 Special sizes, functional limitations may apply.

Product ID	Size [mm]	Width	Height	Weight	Volume	Area	Perimeter	Surface area	Volume weight	Surface weight	Perimeter weight
HVC ---080	800	1000	1200	1400	1600	1800	2000	2200	2400	2500	2600

Skylight module



Opening under load

Glazing unit construction with a total glass thickness of 14 mm																		
Product ID		HVC 067---			HVC 075---			HVC 080---			HVC 090---			HVC 100---				
Product ID	Size [mm]	Width	675			750			800			900			1000			
			Chain stroke [mm]	Electric current requirement [AMP]	Snow Load [Pa]	Chain stroke [mm]	Electric current requirement [AMP]	Snow Load [Pa]	Chain stroke [mm]	Electric current requirement [AMP]	Snow Load [Pa]	Chain stroke [mm]	Electric current requirement [AMP]	Snow Load [Pa]	Chain stroke [mm]	Electric current requirement [AMP]	Snow Load [Pa]	
HVC ---080	800	N0800	353	2.5	353	1984	2.5	353	1768	2.5	353	1644	2.5	353	1434	2.5	353	1263
		N1000		3.0		2603	3.0		2332	3.0		2177	3.0		1913	3.0		1698
		N1100		3.0		2913	3.0		2615	3.0		2444	3.0		2153	3.0		1916
		N1200		3.0		3223	3.0		2897	3.0		2710	3.0		2393	3.0		2133
		N1300		3.0		3533	3.0		3179	3.0		2976	3.0		2632	3.0		2351
HVC ---100	1000	N0800	410	2.5	439	1533	2.5	439	1359	2.5	439	1260	2.5	439	1090	2.5	439	952
		N1000		3.0		2034	3.0		1815	3.0		1690	3.0		1477	3.0		1303
		N1100		3.0		2284	3.5		2043	3.5		1905	3.5		1671	3.5		1479
		N1200		3.0		2534	3.5		2271	3.5		2120	3.5		1864	3.5		1655
		N1300		4.0		2785	3.5		2499	3.5		2336	3.5		2058	3.5		1831
HVC ---120	1200	N0800	410	2.5	460	1228	3.0	460	1082	3.0	526	999	3.0	526	857	3.0	526	741
		N1000		3.0		1648	3.0		1465	3.5		1360	3.5		1182	3.5		1036
		N1100		3.0		1858	3.5		1656	3.5		1540	3.5		1344	3.5		1184
		N1200		3.0		2068	3.5		1847	4.0		1721	4.0		1506	4.0		1331
		N1300		4.0		2278	4.0		2039	4.0		1902	4.0		1669	4.0		1479
HVC ---140	1400	N0800	410	2.5	460	1008	3.0	460	882	3.0	530	811	3.5	610	689	3.5	610	589
		N1000		3.0		1369	3.0		1212	3.5		1122	4.0		968	4.0		843
		N1100		3.0		1550	3.5		1377	3.5		1277	4.0		1108	4.0		970
		N1200		3.0		1731	3.5		1541	4.0		1432	4.0		1248	4.0		1097
		N1300		4.0		1912	4.0		1706	4.0		1588	4.0		1388	4.0		1224
HVC ---160	1600	N0800	410	2.5	460	841	3.0	460	731	3.0	530	668	3.5	610	561	3.5	700	474
		N1000		3.0		1159	3.0		1020	3.5		941	4.0		807	4.0		697
		N1100		3.0		1317	3.5		1165	3.5		1078	4.0		930	4.0		809
		N1200		3.0		1476	3.5		1310	4.0		1214	4.0		1052	4.0		920
		N1300		4.0		1635	4.0		1454	4.0		1351	4.0		1175	4.0		1032
HVC ---180	1800	N0800	410	2.5	460	711	3.0	460	613	3.0	530	557	3.5	610	462	3.5	700	384
		N1000		3.0		994	3.0		871	3.5		800	4.0		681	4.0		583
		N1100		3.0		1135	3.5		1000	3.5		922	4.0		790	4.0		682
		N1200		3.0		1277	3.5		1128	4.0		1044	4.0		899	4.0		782
		N1300		4.0		1418	4.0		1257	4.0		1165	4.0		1009	4.0		881
HVC ---200	2000	N0800	410	2.5	460	606	3.0	460	518	3.0	530	467	3.5	610	382	3.5	700	312
		N1000		3.0		861	3.0		750	3.5		687	4.0		579	4.0		491
		N1100		3.0		989	3.5		866	3.5		796	4.0		678	4.0		581
		N1200		3.0		1116	3.5		983	4.0		906	4.0		776	4.0		670
		N1300		4.0		1244	4.0		1099	4.0		1016	4.0		875	4.0		760
HVC ---220	2200	N0800	410	2.5	460	520	3.0	460	439	3.0	530	394	3.5	610	316	3.5	700	252
		N1000		3.0		752	3.0		651	3.5		594	4.0		495	4.0		415
		N1100		3.0		868	3.5		757	3.5		693	4.0		585	4.0		497
		N1200		3.0		984	3.5		863	4.0		793	4.0		675	4.0		579
		N1300		4.0		1101	4.0		969	4.0		893	4.0		765	4.0		660
HVC ---240	2400	N800	410	2.5	460	447	3.0	460	374	3.0	530	332	3.5	610	261	3.5	700	202
		N1000		3.0		661	3.0		569	3.5		516	4.0		426	4.0		352
		N1100		3.0		768	3.5		666	3.5		607	4.0		508	4.0		427
		N1200		3.0		874	3.5		763	4.0		699	4.0		591	4.0		502
		N1300		4.0		981	4.0		860	4.0		791	4.0		673	4.0		577

The tables illustrate the performance for modules opening under load in accordance with EN 12101-2. The provided performance is NOT equal to structural load bearing capacity of an actual application. The design of a roof light must therefore be dimensioned to fit the specific building project, local architectural style and practice.

Standard size.
 Special sizes, functional limitations may apply.

Skylight module



Opening under load

Glazing unit construction with a total glass thickness of 18 mm																				
Product ID		HVC 067---			HVC 075---			HVC 080---			HVC 090---			HVC 100---						
Height	Size [mm]	Width	675			750			800			900			1000					
	Motor program	Chain stroke [mm]	Electric current requirement [AMP]	Snow Load [Pa]	Chain stroke [mm]	Electric current requirement [AMP]	Snow Load [Pa]	Chain stroke [mm]	Electric current requirement [AMP]	Snow Load [Pa]	Chain stroke [mm]	Electric current requirement [AMP]	Snow Load [Pa]	Chain stroke [mm]	Electric current requirement [AMP]	Snow Load [Pa]				
HVC ---080	800	N0800	353	2.5	353	2.5	353	2.5	353	2.5	353	2.5	353	2.5	353	2.5	353			
		N1000		3.0		1911		3.0		1693		3.0		1569		3.0		1357	3.0	1184
		N1100		3.0		2530		3.0		2258		3.0		2102		3.0		1836	3.0	1620
		N1200		3.0		2840		3.0		2540		3.0		2368		3.0		2076	3.0	1837
		N1300		3.0		3150		3.0		2822		3.0		2634		3.0		2316	3.0	2055
HVC ---100	1000	N0800	410	2.5	439	2.5	439	2.5	439	2.5	439	2.5	439	2.5	439	2.5	439			
		N1000		3.0		1459		3.0		1284		3.0		1183		3.0		1012	3.0	872
		N1100		3.0		1960		3.0		1740		3.0		1613		3.0		1399	3.0	1224
		N1200		3.0		2210		3.5		1968		3.5		1829		3.5		1593	3.5	1400
		N1300		4.0		2460		3.5		2196		3.5		2044		3.5		1786	3.5	1576
HVC ---120	1200	N0800	410	2.5	460	3.0	526	3.0	526	3.0	526	3.0	526	3.0	526	3.0	526			
		N1000		3.0		1153		3.0		1006		3.0		921		3.0		778	3.0	661
		N1100		3.0		1573		3.0		1388		3.5		1282		3.5		1103	3.5	956
		N1200		3.0		1783		3.5		1580		3.5		1463		3.5		1265	3.5	1103
		N1300		4.0		1993		4.0		1771		4.0		1644		4.0		1427	4.0	1251
HVC ---140	1400	N0800	410	2.5	460	3.0	530	3.0	530	3.0	530	3.0	530	3.0	530	3.0	530			
		N1000		3.0		932		3.0		805		3.0		733		3.5		609	3.5	508
		N1100		3.0		1294		3.0		1135		3.5		1044		4.0		889	4.0	762
		N1200		3.0		1475		3.5		1299		3.5		1199		4.0		1028	4.0	889
		N1300		4.0		1655		4.0		1464		4.0		1354		4.0		1168	4.0	1016
HVC ---160	1600	N0800	410	2.5	460	3.0	530	3.0	530	3.0	530	3.0	530	3.0	530	3.0	530			
		N1000		3.0		765		3.0		654		3.0		590		3.5		481	3.5	393
		N1100		3.0		1083		3.0		943		3.5		863		4.0		727	4.0	616
		N1200		3.0		1241		3.5		1088		3.5		999		4.0		850	4.0	727
		N1300		4.0		1400		3.5		1232		4.0		1136		4.0		972	4.0	839
HVC ---180	1800	N0800	410	2.5	460	3.0	530	3.0	530	3.0	530	3.0	530	3.0	530	3.0	530			
		N1000		3.0		634		3.0		535		3.0		478		3.5		381	3.5	302
		N1100		3.0		917		3.0		793		3.5		721		4.0		600	4.0	501
		N1200		3.0		1059		3.5		922		3.5		843		4.0		710	4.0	600
		N1300		4.0		1200		3.5		1051		4.0		965		4.0		819	4.0	700
HVC ---200	2000	N0800	410	2.5	460	3.0	530	3.0	530	3.0	530	3.0	530	3.0	530	3.0	530			
		N1000		3.0		529		3.0		440		3.0		388		3.5		301	3.5	230
		N1100		3.0		784		3.0		672		3.5		608		4.0		498	4.0	409
		N1200		3.0		912		3.5		788		3.5		717		4.0		597	4.0	499
		N1300		4.0		1040		3.5		905		4.0		827		4.0		696	4.0	588
HVC ---220	2200	N0800	410	2.5	460	3.0	530	3.0	530	3.0	530	3.0	530	3.0	530	3.0	530			
		N1000		3.0		443		3.0		361		3.0		314		3.5		235	3.5	170
		N1100		3.0		675		3.0		573		3.5		514		4.0		415	4.0	333
		N1200		3.0		792		3.5		679		3.5		614		4.0		504	4.0	415
		N1300		4.0		908		3.5		785		4.0		714		4.0		594	4.0	496
HVC ---240	2400	N800	410	2.5	460	3.0	530	3.0	530	3.0	530	3.0	530	3.0	530	3.0	530			
		N1000		3.0		371		3.0		296		3.0		253		3.5		180	3.5	120
		N1100		3.0		584		3.0		490		3.5		436		4.0		345	4.0	270
		N1200		3.0		691		3.5		587		3.5		528		4.0		427	4.0	345
		N1300		4.0		797		3.5		684		4.0		620		4.0		510	4.0	420
HVC ---260	2600	N0800	410	2.5	460	3.0	530	3.0	530	3.0	530	3.0	530	3.0	530	3.0	530			
		N1000		3.0		309		3.0		240		3.0		211		3.5		156	3.5	118
		N1100		3.0		507		3.0		420		3.5		371		4.0		284	4.0	222
		N1200		3.0		605		3.5		510		3.5		461		4.0		371	4.0	294
		N1300		4.0		704		3.5		599		4.0		542		4.0		458	4.0	354
HVC ---280	2800	N0800	410	2.5	460	3.0	530	3.0	530	3.0	530	3.0	530	3.0	530	3.0	530			
		N1000		3.0		257		3.0		200		3.0		171		3.5		126	3.5	97
		N1100		3.0		440		3.0		340		3.5		301		4.0		222	4.0	170
		N1200		3.0		532		3.5		420		3.5		371		4.0		284	4.0	222
		N1300		4.0		623		3.5		510		4.0		461		4.0		371	4.0	294

The tables illustrate the performance for modules opening under load in accordance with EN 12101-2. The provided performance is NOT equal to structural load bearing capacity of an actual application. The design of a roof light must therefore be dimensioned to fit the specific building project, local architectural style and practice.

Standard size.

Special sizes, functional limitations may apply.

Only applicable for double glazing variants with -T.

Product ID	Size [mm]	Width	Height	Weight	Volume	Area	Perimeter	Material	Color	Finish	Accessories
HVC 067---	675	675	1000	1000	1000	1000	1000	1000	1000	1000	1000
HVC 075---	750	750	1000	1000	1000	1000	1000	1000	1000	1000	1000
HVC 080---	800	800	1000	1000	1000	1000	1000	1000	1000	1000	1000
HVC 090---	900	900	1000	1000	1000	1000	1000	1000	1000	1000	1000
HVC 100---	1000	1000	1000	1000	1000	1000	1000	1000	1000	1000	1000

Skylight module

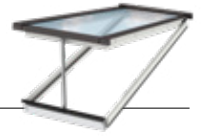

Opening under load

Glazing unit construction with a total glass thickness of 22 mm																	
Product ID	Size [mm]	Width	HVC 067---			HVC 075---			HVC 080---			HVC 090---			HVC 100---		
	Height	Motor program	Chain stroke [mm]	Electric current requirement [AMP]	Snow Load [Pa]	Chain stroke [mm]	Electric current requirement [AMP]	Snow Load [Pa]	Chain stroke [mm]	Electric current requirement [AMP]	Snow Load [Pa]	Chain stroke [mm]	Electric current requirement [AMP]	Snow Load [Pa]	Chain stroke [mm]	Electric current requirement [AMP]	Snow Load [Pa]
HVC ---080	800	N0800	353	2.5	1850	353	2.5	1630	353	2.5	1504	353	2.5	1289	353	2.5	1114
		N1000		3.0	2470		3.0	2194		3.0	2037		3.0	1769		3.0	1544
		N1100		3.0	2780		3.0	2477		3.0	2303		3.0	2008		3.0	1767
		N1200		3.0	3089		3.0	2759		3.0	2569		3.0	2248		3.0	1985
		N1300		3.0	3399		3.0	3041		3.0	2836		3.0	2487		3.0	2203
HVC ---100	1000	N0800	410	2.5	1394	439	2.5	1216	439	2.5	1114	439	2.5	941	439	2.5	799
		N1000		3.0	1895		3.0	1672		3.0	1544		3.0	1328		3.0	1150
		N1100		3.0	2145		3.5	1900		3.5	1760		3.5	1521		3.5	1326
		N1200		3.0	2395		3.5	2128		3.5	1975		3.5	1715		3.5	1502
		N1300		4.0	2646		3.5	2356		3.5	2190		3.5	1908		3.5	1678
HVC ---120	1200	N0800	410	2.5	1086	460	3.0	936	526	3.0	850	526	3.0	704	526	3.0	585
		N1000		3.0	1505		3.0	1318		3.5	1211		3.5	1029		3.5	880
		N1100		3.0	1715		3.5	1510		3.5	1392		3.5	1191		3.5	1028
		N1200		3.0	1925		3.5	1701		4.0	1572		4.0	1354		4.0	1175
		N1300		4.0	2135		4.0	1892		4.0	1753		4.0	1516		4.0	1323
HVC ---140	1400	N0800	410	2.5	862	460	3.0	733	530	3.0	659	610	3.5	533	610	3.5	431
		N1000		3.0	1224		3.0	1063		3.5	970		4.0	813		4.0	685
		N1100		3.0	1405		3.5	1227		3.5	1126		4.0	953		4.0	812
		N1200		3.0	1586		3.5	1392		4.0	1281		4.0	1093		4.0	939
		N1300		4.0	1766		4.0	1557		4.0	1437		4.0	1233		4.0	1066
HVC ---160	1600	N0800	410	2.5	694	460	3.0	580	530	3.0	515	610	3.5	404	700	3.5	314
		N1000		3.0	1011		3.0	869		3.5	788		4.0	650		4.0	537
		N1100		3.0	1170		3.5	1014		3.5	925		4.0	773		4.5	649
		N1200		3.0	1329		3.5	1159		4.0	1061		4.0	895		4.5	760
		N1300		4.0	1487		4.0	1303		4.0	1198		4.0	1018		5.0	872
HVC ---180	1800	N0800	410	2.5	562	460	3.0	460	530	3.0	402	610	3.5	303	700	3.5	223
		N1000		3.0	845		3.0	718		3.5	645		4.0	522		4.0	422
		N1100		3.0	986		3.5	847		3.5	767		4.0	632		4.5	521
		N1200		3.0	1128		3.5	976		4.0	889		4.0	741		4.5	620
		N1300		4.0	1269		4.0	1105		4.0	1011		4.0	850		5.0	720
HVC ---200	2000	N0800	410	2.5	456	460	3.0	364	530	3.0	311	610	3.5	222	700	3.5	149
		N1000		3.0	711		3.0	596		3.5	531		4.0	420		4.0	329
		N1100		3.0	838		3.5	713		3.5	641		4.0	518		4.5	418
		N1200		3.0	966		3.5	829		4.0	750		4.0	617		4.5	508
		N1300		4.0	1094		4.0	945		4.0	860		4.0	716		5.0	598
HVC ---220	2200	N0800	410	2.5	368	460	3.0	285	530	3.0	237	610	3.5	155	700	3.5	89
		N1000		3.0	601		3.0	497		3.5	437		4.0	335		4.0	252
		N1100		3.0	717		3.5	602		3.5	537		4.0	425		4.5	334
		N1200		3.0	833		3.5	708		4.0	637		4.0	515		4.5	416
		N1300		4.0	950		4.0	814		4.0	737		4.0	605		5.0	497
HVC ---240	2400	N800	410	2.5	295	460	3.0	219	530	3.0	174	610	3.5	100	700	3.5	38
		N1000		3.0	509		3.0	413		3.5	358		4.0	265		4.0	188
		N1100		3.0	616		3.5	510		3.5	450		4.0	347		4.5	263
		N1200		3.0	722		3.5	607		4.0	542		4.0	430		4.5	338
		N1300		4.0	829		4.0	705		4.0	633		4.0	512		5.0	413
HVC ---260	2600	N0800	410	2.5	234	460	3.0	162	530	3.0	127	610	3.5	77	700	3.5	29
		N1000		3.0	431		3.0	342		3.5	287		4.0	187		4.0	117
		N1100		3.0	529		3.5	432		3.5	377		4.0	277		4.5	187
		N1200		3.0	628		3.5	522		4.0	467		4.0	367		4.5	267
		N1300		4.0	727		4.0	612		4.0	557		4.0	457		5.0	347
HVC ---280	2800	N0800	410	2.5	180	460	3.0	132	530	3.0	97	610	3.5	52	700	3.5	19
		N1000		3.0	364		3.0	274		3.5	217		4.0	127		4.0	67
		N1100		3.0	455		3.5	365		3.5	308		4.0	218		4.5	158
		N1200		3.0	547		3.5	457		4.0	400		4.0	309		4.5	249
		N1300		4.0	639		4.0	549		4.0	492		4.0	401		5.0	340

The tables illustrate the performance for modules opening under load in accordance with EN 12101-2. The provided performance is NOT equal to structural load bearing capacity of an actual application. The design of a roof light must therefore be dimensioned to fit the specific building project, local architectural style and practice.

Standard size.
 Special sizes, functional limitations may apply.

Skylight module

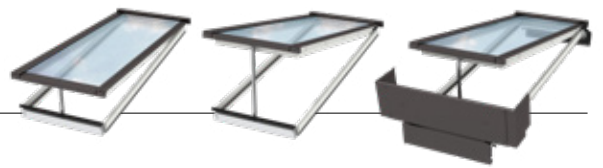

Smoke ventilation systems

A smoke ventilation system always has a building specific design, incorporating smoke ventilators, controls, air inlets and mechanical ventilation.

Designing a smoke ventilation system is therefore a rather complex matter, which must be addressed by skilled and authorized fire engineers in order to obtain an adequate level of performance and safety.

The design covers all relevant parameters such as the location of the building, height and shape of the roof, position of ventilators on the

roof, relative position to each other, facades and doors providing air intake, mechanical ventilation, evacuation plan and escape routes, and the natural and artificial wind obstacles in the surroundings of the building.

The VELUX Group provides the essential performance characteristics of each individual CE-marked VELUX Modular Skylight in accordance with EN 12101-2, but cannot validate the functionality and safety of the complete system.

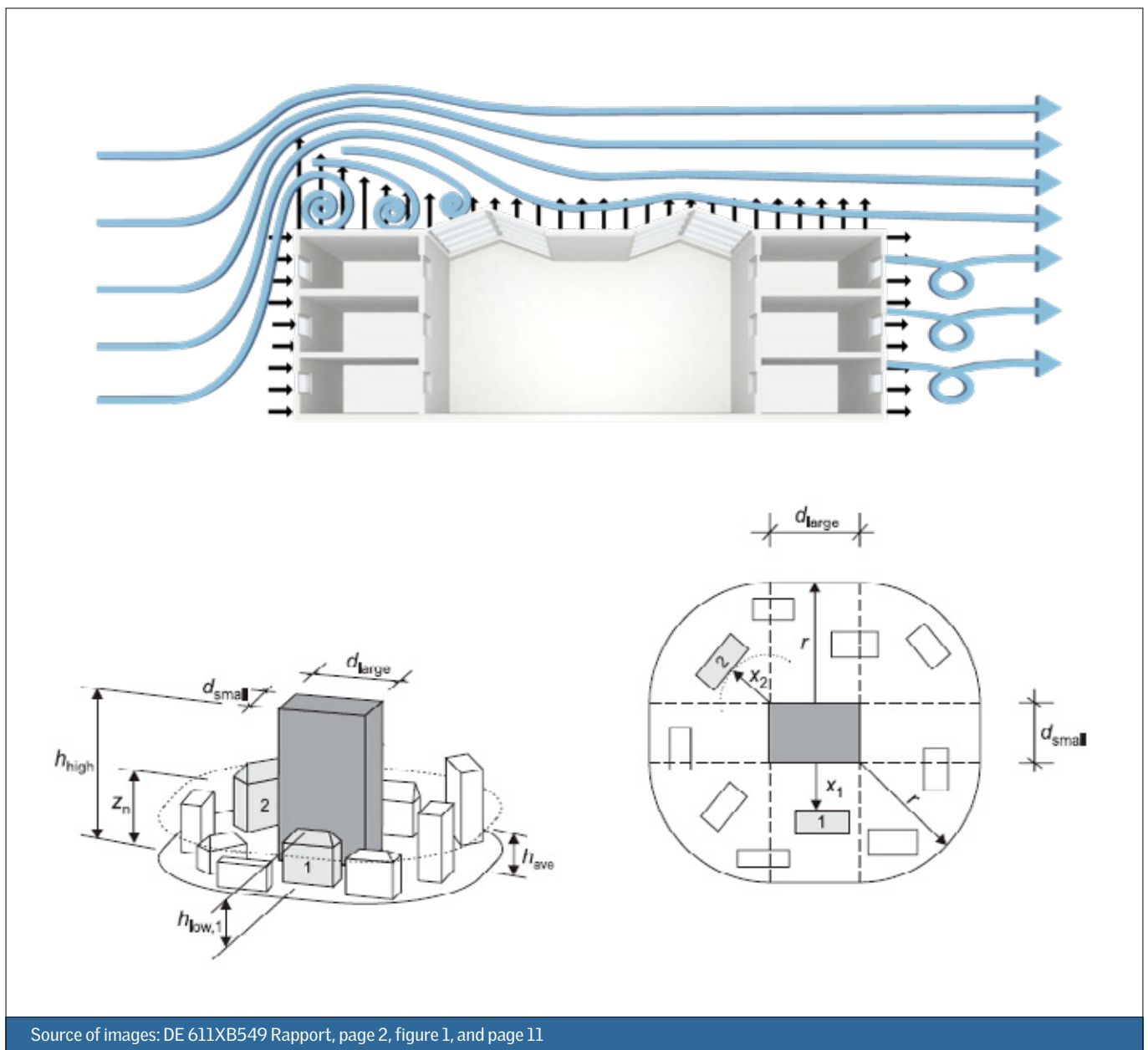

Source of images: DE 611XB549 Rapport, page 2, figure 1, and page 11

Product	Accessories	Dimensions	Weight	Material	Color	Finish	Notes
VELUX smoke venting modular skylights	VELUX KCD wind deflector	1000 x 1000 mm	12 kg	Aluminum	White	RAL 9003	See technical drawing for details
VELUX smoke venting modular skylights	VELUX KCD wind deflector	1000 x 1000 mm	12 kg	Aluminum	White	RAL 9003	See technical drawing for details

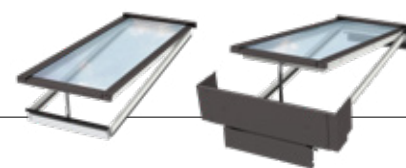

Skylight module

VELUX wind deflector for smoke venting modules

Whenever it is required to obtain an Aerodynamic free area (A_a) which is accountable in any wind condition, i.e. considering the possible side wind effect, a possible solution is to install smoke ventilators with prefabricated VELUX wind deflector KCD. The wind deflector KCD is specifically designed to change the wind profile in any wind direction and to ensure that negative pressure i.e. wind suction occurs in the direct surroundings of the opening of the modular skylight. This enables smoke exhaust even in adverse wind conditions, provided that the entire building and smoke ventilation system is designed appropriately by authorized fire engineers.

The wind deflector comes in two variants: KCD W00H00 0040 that covers one smoke venting module and KCD 0080 that covers three skylight modules, one smoke venting module in the middle of two fixed modules of the same width. A skylight configuration with six modules can thus contain two smoke venting modules with KCD 0080 and four fixed modules. Please contact VELUX for detailed design advice.

The aerodynamic performance of the modular skylights with and without deflectors in accordance with EN 12101-2 is expressed on pages 92 and 93.

VELUX smoke venting modular skylights can be used without wind deflector in roof mounted applications, when local regulations and design conditions are allowing to do so.

VELUX smoke venting modular skylights installed in roof mounted applications i.e. up to 60° inclination are wind sensitive, which means that negative discharge i.e. air intake may occur in unfavourable wind conditions. This must be regarded and addressed by the building owner when designing the building and planning with wind sensitive smoke ventilators. To prevent negative discharge, the building owner must take steps to incorporate the product as a part of the total solution that can be approved by the local authorities. The solution could, for instance, be a VELUX KCD wind deflector, or a wind direction sensor in connection with multi-direction placement of smoke ventilators, or another device/roof integrated solution that ensures a sufficient aerodynamic free area.

VELUX wind deflector KCD is not applicable above 60° installation pitch, on so-called wall-mounted smoke ventilators. Smoke ventilators installed in this range are to be considered wind sensitive by default in accordance with EN 12101-2. When a smoke ventilator is used in wall-mounted applications i.e. above 60° installation inclination the aerodynamic area must be by default expressed without influence of side wind, therefore the use of a smoke deflector is meaningless in such applications. Wind deflector KCD is furthermore not compatible with narrow bottom flashing, Northlight flashings, Ridgelight on Pitch flashings and Step solution flashings.

Skylight module



Wind deflector KCD W00H00 0040

Material	Aluminium
Material thickness	3 mm
Surface treatment	Powder coated (60 - 120µ)
Colour	NCS S7500-N, gloss 30



Product name	VELUX skylight	Product code	0080
Material	Aluminium	Material thickness	3 mm
Surface treatment	Anodized	Colour	Nature anodized Optional - coloured powder coating
Weight	10 kg	Dimensions (L x W x H)	1200 x 1200 x 120
Installation	Standard	Accessories	None
Warranty	10 years	Notes	See technical drawing

Skylight module

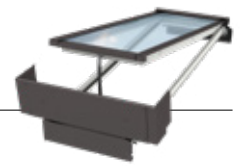

Wind deflector KCD 0080

Material	Aluminium
Material thickness	3 mm
Surface treatment	Anodized
Colour	Nature anodized Optional - coloured powder coating





Skylight module

Definitions

In accordance with EN 12101-2:

C_v [-] Coefficient of discharge that states the ratio between A_a and A_v ($C_v = A_a/A_v$). For roof-mounted smoke and heat exhaust ventilators the value of C_v is the lower of C_{v0} and C_{vw} .

For wall-mounted smoke and heat exhaust ventilators, C_v is not to be tested with wind influence i.e. $C_v = C_{v0}$.

C_{v0} [-] Coefficient of discharge calculated based on pressure testing without side wind influence.

C_{vw} [-] Coefficient of discharge calculated based on pressure testing with side wind influence.

A_a [m^2] A_a [m^2] Aerodynamic free area ($A_a = A_v \times C_v$). May be described as the effective area of the ventilator taking into account reductions in air flow along edges and around the openable panel as well as motors etc.

A_v [m^2] Geometric area, corresponds to frame aperture area.

Roof-mounted:

Smoke ventilators installed from 0° up to and including 60° . VELUX Modular Skylights installed from 5° to 60° are proven wind sensitive. This must be considered when planning the smoke ventilation of the building.

Wall-mounted:

Smoke ventilators installed above 60° up to 90° . Wall-mounted smoke ventilators are, as per definition, wind sensitive regardless of the design.

In accordance with EN 13141-1

A_c [m^2] Geometric free area corresponds to the minimum unobstructed opening of the openable modular skylights in natural comfort ventilation position.

The area is calculated using the total opening area of the ventilator, in case of modular skylight top-hung ventilators from the front opening and the side triangles. Not identical to **A_g [m^2], which is calculated in smoke ventilation opening position.**

Used to define natural ventilation performance of comfort venting modular skylights and dual purpose smoke venting modular skylights in comfort ventilation use.

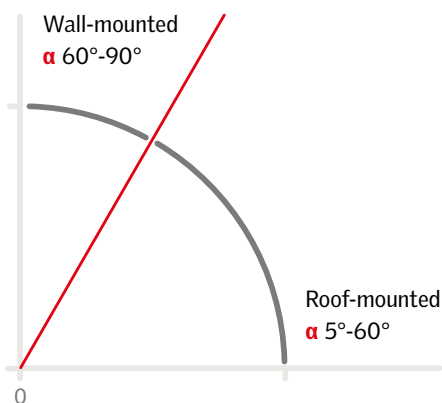

Product	Accessories	Dimensions	Weight	Material
VELUX skylight	VELUX skylight	1200 x 1800	15 kg	Aluminum
VELUX skylight	VELUX skylight	1500 x 2250	20 kg	Aluminum
VELUX skylight	VELUX skylight	2000 x 3000	28 kg	Aluminum
VELUX skylight	VELUX skylight	2400 x 3600	35 kg	Aluminum
VELUX skylight	VELUX skylight	3000 x 4500	45 kg	Aluminum
VELUX skylight	VELUX skylight	3600 x 5400	55 kg	Aluminum
VELUX skylight	VELUX skylight	4500 x 6750	70 kg	Aluminum
VELUX skylight	VELUX skylight	5400 x 8100	85 kg	Aluminum
VELUX skylight	VELUX skylight	6750 x 10125	105 kg	Aluminum
VELUX skylight	VELUX skylight	8100 x 12150	125 kg	Aluminum
VELUX skylight	VELUX skylight	10125 x 15175	155 kg	Aluminum
VELUX skylight	VELUX skylight	12150 x 18225	185 kg	Aluminum
VELUX skylight	VELUX skylight	15175 x 22775	235 kg	Aluminum
VELUX skylight	VELUX skylight	18225 x 27325	285 kg	Aluminum
VELUX skylight	VELUX skylight	22775 x 33925	355 kg	Aluminum
VELUX skylight	VELUX skylight	27325 x 40525	425 kg	Aluminum
VELUX skylight	VELUX skylight	33925 x 49425	515 kg	Aluminum
VELUX skylight	VELUX skylight	40525 x 58325	605 kg	Aluminum
VELUX skylight	VELUX skylight	49425 x 70000	745 kg	Aluminum
VELUX skylight	VELUX skylight	58325 x 81675	885 kg	Aluminum
VELUX skylight	VELUX skylight	70000 x 100000	1085 kg	Aluminum

Skylight module



Comfort ventilation

Geometric free area: A_c [m²]

In accordance with EN 13141-1



Smoke ventilation

Geometric area: A_v [m²]
Aerodynamic free area: $A_a = A_v \times C_v$

In accordance with EN 12101-2

Skylight module



Table for European values

Ventilation characteristics for HVC (European values)																		
Size of Skylights	Smoke ventilation characteristics HVC-----AB														Comfort ventilation (EN13141-1)			
	Actuator chain stroke [mm]	Opening angle	Geometric area: A_v [m ²]	Discharge coefficient (C_d) (EN 12101-2)						Aerodynamic free area (A_a) [m ²] (EN 12101-2)						HVC-----CB and HVC-----AB in comfort function		
				Without deflector		With deflector type KCD 0080		With deflector type KCD 0040		Without deflector			With deflector type KCD 0080		With deflector type KCD 0040	Actuator chain stroke [mm]	Opening angle	Geometric free area: A_c [m ²]
				without side wind	with side wind	without side wind	with side wind	without side wind	with side wind	5° ≤ installation inclination ≤ 60°		installation inclination > 60°	5° ≤ installation inclination ≤ 60°		5° ≤ installation inclination ≤ 60°			
				C_{v0}	C_{vw}	C_{v0}	C_{vw}	C_{v0}	C_{vw}	$A_{a, Roof}^{1)}$ without side wind ²⁾	$A_{a, Roof}$ with side wind	$A_{a, Wall}^{3)}$	$A_{a, Roof}^{4)}$		$A_{a, Roof}^{4)}$			
675 x 800	353	25.0°	0.48	0.42	0.00	0.49	0.59	0.40	0.26	0.20	0.00	0.20	0.24	0.13	260	18.5°	0.16	
675 x 1000	410	23.0°	0.61	0.44	0.00	0.46	0.60	0.40	0.24	0.27	0.00	0.27	0.28	0.15	260	14.5°	0.17	
675 x 1200	410	19.5°	0.74	0.40	0.00	0.43	0.57	0.38	0.22	0.30	0.00	0.30	0.32	0.16	260	12.5°	0.19	
675 x 1400	410	16.5°	0.87	0.36	0.00	0.40	0.54	0.35	0.20	0.31	0.00	0.31	0.35	0.17	260	10.5°	0.20	
675 x 1600	410	14.5°	1.00	0.33	0.00	0.38	0.52	0.33	0.19	0.33	0.00	0.33	0.38	0.19	260	9.0°	0.22	
675 x 1800	410	13.0°	1.12	0.34	0.00	0.36	0.49	0.34	0.19	0.38	0.00	0.38	0.40	0.21	260	8.0°	0.23	
675 x 2000	410	11.5°	1.25	0.32	0.00	0.33	0.45	0.33	0.16	0.40	0.00	0.40	0.41	0.20	260	7.5°	0.25	
675 x 2200	410	10.5°	1.38	0.31	0.00	0.32	0.43	0.32	0.17	0.43	0.00	0.43	0.44	0.23	260	6.5°	0.26	
675 x 2400	410	9.5°	1.51	0.29	0.00	0.30	0.41	0.30	0.16	0.44	0.00	0.44	0.45	0.24	260	6.0°	0.28	
675 x 2600	410	9.0°	1.64	0.31	0.00	-	-	0.32	0.17	0.50	0.00	0.50	-	0.28	260	5.5°	0.29	
675 x 2800	410	8.0°	1.76	0.28	0.00	-	-	0.31	0.18	0.49	0.00	0.49	-	0.32	260	5.5°	0.31	
750 x 800	353	25.0°	0.54	0.41	0.00	0.47	0.56	0.38	0.26	0.22	0.00	0.22	0.25	0.14	260	18.5°	0.17	
750 x 1000	439	25.0°	0.68	0.46	0.00	0.49	0.61	0.40	0.24	0.31	0.00	0.31	0.33	0.16	260	14.5°	0.19	
750 x 1200	460	21.5°	0.83	0.44	0.00	0.44	0.57	0.41	0.23	0.36	0.00	0.36	0.36	0.19	260	12.5°	0.20	
750 x 1400	460	18.5°	0.97	0.39	0.00	0.41	0.54	0.38	0.22	0.38	0.00	0.38	0.40	0.21	260	10.5°	0.22	
750 x 1600	460	16.0°	1.11	0.37	0.00	0.39	0.51	0.36	0.21	0.41	0.00	0.41	0.43	0.23	260	9.0°	0.23	
750 x 1800	460	14.5°	1.25	0.36	0.00	0.37	0.50	0.35	0.19	0.45	0.00	0.45	0.46	0.24	260	8.0°	0.25	
750 x 2000	460	13.0°	1.40	0.37	0.00	0.36	0.48	0.35	0.19	0.52	0.00	0.52	0.50	0.27	260	7.5°	0.26	
750 x 2200	460	12.0°	1.54	0.37	0.00	0.34	0.46	0.36	0.19	0.57	0.00	0.57	0.52	0.29	260	6.5°	0.27	
750 x 2400	460	11.0°	1.68	0.35	0.00	0.33	0.44	0.35	0.15	0.59	0.00	0.59	0.56	0.25	260	6.0°	0.29	
750 x 2600	460	10.0°	1.83	0.33	0.00	-	-	0.33	0.16	0.60	0.00	0.60	-	0.29	260	5.5°	0.30	

- ¹⁾ External building surfaces with inclination of 60° or less relative to the horizontal; shed roofs and continuous roof-lights, independent of inclination angle, are considered to be part of the roofs.
- ²⁾ The aerodynamic area has been declared in accordance with EN 12101-2, which means the products have been tested with and without side wind. The aerodynamic area expressed without deflector is wind sensitive which therefore, in connection with the design of the smoke ventilation system, means that steps must be taken to incorporate the products as part of a total solution that can be approved by the local fire authorities. This solution could consist of, for instance, a wind direction sensor, a wind deflector or another device that ensures a sufficient aerodynamic area at all times.
It is the responsibility of the building owner – together with the local fire authorities, if necessary – to ensure the system is specified, installed and operated in accordance with current national legislation and requirements.
- ³⁾ External building surfaces with an inclination of more than 60° relative to the horizontal.
- ⁴⁾ Aerodynamic tests as outlined in EN 12101-2:2003 were conducted both with wind (C_{vw}) and without influence of wind (C_{v0}). In any case, the lower of C_{v0} and C_{vw} is used.

Product Data

Product Name	Model	Material	Color
Product Code	Accessories	Dimensions	Weight
Technical Drawing	Installation Manual	Warranty	CE Marking

Skylight module



Table for European values

Ventilation characteristics for HVC (European values)																		
Size of Skylights	Smoke ventilation characteristics HVC----- ----AB														Comfort ventilation (EN13141-1)			
	Actuator chain stroke [mm]	Opening angle	Geometric area: A_v [m ²]	Discharge coefficient (C_v) (EN 12101-2)						Aerodynamic free area (A_a) [m ²] (EN 12101-2)						HVC----- ----CB and HVC----- ----AB in comfort function		
				Without deflector		With deflector type KCD 0080		With deflector type KCD 0040		Without deflector		With deflector type KCD 0080		With deflector type KCD 0040		Actuator chain stroke [mm]	Opening angle	Geometric free area: A_c [m ²]
				without side wind	with side wind	without side wind	with side wind	without side wind	with side wind	5° ≤ installation inclination ≤ 60°		installation inclination > 60°	5° ≤ installation inclination ≤ 60°	5° ≤ installation inclination ≤ 60°				
				C_{v0}	C_{vw}	C_{v0}	C_{vw}	C_{v0}	C_{vw}	$A_{a, Roof}^{1)}$ without side wind ²⁾	$A_{a, Roof}$ with side wind	$A_{a, Wall}^{3)}$	$A_{a, Roof}^{4)}$	$A_{a, Roof}^{4)}$				
800 x 800	353	25.0°	0.58	0.40	0.00	0.46	0.54	0.37	0.25	0.23	0.00	0.23	0.27	0.14	260			
800 x 1000	439	25.0°	0.73	0.45	0.00	0.48	0.59	0.41	0.24	0.33	0.00	0.33	0.35	0.18	260	14.5°	0.19	
800 x 1200	526	25.0°	0.88	0.48	0.00	0.49	0.63	0.44	0.22	0.42	0.00	0.42	0.43	0.19	260	12.5°	0.21	
800 x 1400	530	21.5°	1.04	0.45	0.00	0.45	0.59	0.41	0.22	0.47	0.00	0.47	0.47	0.23	260	10.5°	0.22	
800 x 1600	530	19.0°	1.19	0.42	0.00	0.43	0.57	0.39	0.22	0.50	0.00	0.50	0.51	0.26	260	9.0°	0.24	
800 x 1800	530	16.5°	1.34	0.39	0.00	0.40	0.54	0.38	0.21	0.52	0.00	0.52	0.54	0.28	260	8.0°	0.25	
800 x 2000	530	15.0°	1.50	0.40	0.00	0.39	0.52	0.39	0.19	0.60	0.00	0.60	0.58	0.28	260	7.5°	0.27	
800 x 2200	530	13.5°	1.65	0.38	0.00	0.37	0.50	0.37	0.18	0.63	0.00	0.63	0.61	0.30	260	6.5°	0.28	
800 x 2400	530	12.5°	1.80	0.37	0.00	0.35	0.47	0.36	0.14	0.67	0.00	0.67	0.63	0.25	260	6.0°	0.30	
900 x 800	353	25.0°	0.65	0.39	0.00	0.43	0.50	0.35	0.25	0.25	0.00	0.25	0.28	0.16	260	18.5°	0.20	
900 x 1000	439	25.0°	0.83	0.44	0.00	0.45	0.57	0.39	0.23	0.36	0.00	0.36	0.37	0.19	260	14.5°	0.21	
900 x 1200	526	25.0°	1.00	0.46	0.00	0.47	0.60	0.42	0.20	0.46	0.00	0.46	0.47	0.20	260	12.5°	0.23	
900 x 1400	610	24.5°	1.17	0.47	0.00	0.47	0.62	0.42	0.18	0.55	0.00	0.55	0.55	0.21	260	10.5°	0.24	
900 x 1600	610	21.5°	1.35	0.45	0.00	0.44	0.58	0.41	0.21	0.61	0.00	0.61	0.59	0.28	260	9.0°	0.25	
900 x 1800	610	19.0°	1.52	0.43	0.00	0.42	0.55	0.41	0.20	0.65	0.00	0.65	0.64	0.30	260	8.0°	0.27	
900 x 2000	610	17.0°	1.69	0.41	0.00	0.40	0.53	0.40	0.18	0.69	0.00	0.69	0.68	0.30	260	7.5°	0.28	
900 x 2200	610	16.0°	1.86	0.40	0.00	0.40	0.52	0.40	0.16	0.75	0.00	0.75	0.75	0.30	260	6.5°	0.30	
900 x 2400	610	14.5°	2.04	0.38	0.00	0.38	0.49	0.38	0.14	0.77	0.00	0.77	0.77	0.29	260	6.0°	0.31	
1000 x 800	353	25.0°	0.73	0.37	0.00	0.40	0.47	0.33	0.25	0.27	0.00	0.27	0.29	0.18	260	18.0°	0.21	
1000 x 1000	439	25.0°	0.92	0.41	0.00	0.43	0.54	0.37	0.21	0.38	0.00	0.38	0.40	0.19	260	14.5°	0.23	
1000 x 1200	526	25.0°	1.11	0.44	0.00	0.45	0.58	0.40	0.18	0.49	0.00	0.49	0.50	0.20	260	12.5°	0.24	
1000 x 1400	610	25.0°	1.31	0.46	0.00	0.46	0.61	0.42	0.16	0.60	0.00	0.60	0.60	0.21	260	10.5°	0.26	
1000 x 1600	700	24.0°	1.50	0.47	0.00	0.46	0.60	0.44	0.17	0.71	0.00	0.71	0.69	0.26	260	9.0°	0.27	
1000 x 1800	700	22.0°	1.69	0.47	0.00	0.44	0.58	0.42	0.17	0.80	0.00	0.80	0.75	0.29	260	8.0°	0.29	
1000 x 2000	700	20.0°	1.89	0.44	0.00	0.43	0.55	0.42	0.16	0.83	0.00	0.83	0.81	0.30	260	7.5°	0.30	
1000 x 2200	700	18.0°	2.08	0.42	0.00	0.42	0.52	0.41	0.15	0.87	0.00	0.87	0.87	0.31	260	6.5°	0.31	
1000 x 2400	700	16.5°	2.27	0.39	0.00	0.40	0.51	0.39	0.13	0.89	0.00	0.89	0.91	0.30	260	6.0°	0.33	

¹⁾ External building surfaces with inclination of 60° or less relative to the horizontal; shed roofs and continuous roof-lights, independent of inclination angle, are considered to be part of the roofs.

²⁾ The aerodynamic area has been declared in accordance with EN 12101-2, which means the products have been tested with and without side wind. The aerodynamic area expressed without deflector is wind sensitive which therefore, in connection with the design of the smoke ventilation system, means that steps must be taken to incorporate the products as part of a total solution that can be approved by the local fire authorities. This solution could consist of, for instance, a wind direction sensor, a wind deflector or another device that ensures a sufficient aerodynamic area at all times.
It is the responsibility of the building owner – together with the local fire authorities, if necessary – to ensure the system is specified, installed and operated in accordance with current national legislation and requirements.

³⁾ External building surfaces with an inclination of more than 60° relative to the horizontal.

⁴⁾ Aerodynamic tests as outlined in EN 12101-2:2003 were conducted both with wind (C_{vw}) and without influence of wind (C_{v0}). In any case, the lower of C_{v0} and C_{vw} is used.

Skylight module



Other relevant aerodynamic areas

The aerodynamic areas below are outside of the scope of EN 12101-2.

They are however used nationally and referred to in national regulations and/or practical guides.

1) A_g [m²] Geometric free area, corresponds to the minimum unobstructed opening area of the smoke ventilators.

The typical use of this parameter is to define the ventilation area of smoke ventilators when they are used as so called cold smoke exhaust ventilators, assuming that the outtake pressure is generated by mechanical extract fans or generated by a chimney stack effect. A typical use of this area is when smoke ventilators are used over staircases. National and local regulations may differ and wherever they exist, they must be followed.

Definition of the geometric free area:

Figure 1.a:
Germany: In accordance with DIN 18232

The area is calculated in relation to the use of the total unobstructed opening area of the ventilator. In case of modular skylight top-hung ventilators it equals to the front opening (A) and the side triangles (B + C).

Not identical to A_c [m²], which is calculated in comfort opening position.

Figure 1.b:
Austria: In accordance with the Guideline TRVB S 111 + addendum 3.3.2018 to point 5.4

The area is calculated in relation to the use of the total unobstructed opening area of the ventilator with some limitations depending on the size and installation inclination and the relation of the opening angle to the installation inclination.

In case of modular skylight top-hung ventilators the value is equal to

- The front opening (A) when the $A_v \leq 1\text{m}^2$
- The front opening (A) when the $A_v > 1\text{m}^2$ and the sash remains below or raises maximum up to horizontal open position
- The front opening (A) plus one of the two side triangles (B)

Figure 1.c:
Belgium: In accordance with NBN S21-208-3

The area is calculated in relation to the use of the total unobstructed opening area of the ventilator. In case of modular skylight top-hung ventilators it equals to the front opening (A).

Figure 2:
Great Britain: Free area of smoke ventilators

- Great Britain: In accordance with Approved Document B, Volume 2, Appendix C, Section 5.b, Diagram C7, figure a

The area is usable as an alternative to the first place cited Aerodynamic Free (A_a) in accordance with BS EN 12101-2 under Section 5.a. whenever it is specified in the requirements.

Code	Dimensions (mm)	Weight (kg)	Material
...

Skylight module

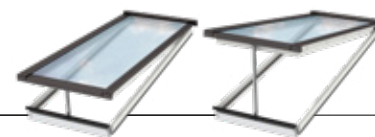

1.a:



Smoke ventilation

Geometric free area: A_g [m²] in Germany

In accordance with DIN 18232

Geometric free area: A_g [m²] in Denmark

In accordance with DBI 027

1.b:



Smoke ventilation

Geometric area: A_g [m²] in Austria

In accordance with Guideline TRVB S 111
+ addendum 3.3.2018 to point 5.4.

1.c:



Smoke ventilation

Geometric area: A [m²] in Belgium

In accordance with NBN S21-208-3

2:



Smoke ventilation

Free area of smoke ventilators: A in Great Britain

In accordance with Approved Document B,
Volume 2, Appendix D, Section 5.b,
Diagram C7, figure a

Skylight module



Table for country specific values

Additional ventilation characteristics HVC									
Basic geometry data				Additional national smoke ventilation characteristics HVC-----AB					
Size of Skylights	Actuator chain stroke [mm]	Opening angle	Geometric area: A_v [m ²] (EN 12101-2)	Germany	Denmark	Belgium	Austria		Great Britain
				DIN 18232	DBI 027	NBN S21-208-3:2018	Guideline TRVB S 111 + addendum 3.3.2018 to point 5.4.		
				Geometric free area: A_g [m ²]	Cold smoke exhaust area: A_g [m ²]	Geometric free area (A) in accordance with NBN S21-208-3:2018	The installation inclination of the module is smaller than the opening angle of the sash relative to horizontal, i.e the sash raises above horizontal in fully opened position.	The installation inclination of the module is larger than the opening angle of the sash relative to horizontal, i.e the sash remains below or raises maximum up to horizontal in fully opened position	The Free Area Smoke Ventilator in accordance with Approved Document B, Volume 2, Appendix D, Section 5.b, Diagram C7, figure a.
							Geometric area: A_g [m ²]		Area (A) [m ²] *
675 x 800	353	25.0°	0.48	0.28	0.28	0.16	0.16	0.16	0.14
675 x 1000	410	23.0°	0.61	0.39	0.39	0.20	0.20	0.20	0.18
675 x 1200	410	19.5°	0.74	0.44	0.44	0.20	0.20	0.20	0.17
675 x 1400	410	16.5°	0.87	0.48	0.48	0.20	0.20	0.20	0.17
675 x 1600	410	14.5°	1.00	0.52	0.52	0.20	0.20	0.20	0.17
675 x 1800	410	13.0°	1.12	0.56	0.56	0.20	0.38	0.20	0.17
675 x 2000	410	11.5°	1.25	0.60	0.60	0.20	0.40	0.20	0.16
675 x 2200	410	10.5°	1.38	0.64	0.64	0.20	0.42	0.20	0.16
675 x 2400	410	9.5°	1.51	0.68	0.68	0.20	0.44	0.20	0.16
675 x 2600	410	9.0°	1.64	0.72	0.72	0.20	0.46	0.20	0.16
675 x 2800	410	8.0°	1.76	0.76	0.76	0.20	0.48	0.20	0.16
750 x 800	353	25.0°	0.54	0.30	0.30	0.18	0.18	0.18	0.16
750 x 1000	439	25.0°	0.68	0.46	0.46	0.24	0.24	0.24	0.22
750 x 1200	460	21.5°	0.83	0.55	0.55	0.26	0.26	0.26	0.23
750 x 1400	460	18.5°	0.97	0.60	0.60	0.26	0.26	0.26	0.23
750 x 1600	460	16.0°	1.11	0.65	0.65	0.26	0.45	0.26	0.22
750 x 1800	460	14.5°	1.25	0.70	0.70	0.26	0.48	0.26	0.22
750 x 2000	460	13.0°	1.40	0.75	0.75	0.26	0.50	0.26	0.22
750 x 2200	460	12.0°	1.54	0.80	0.80	0.26	0.53	0.26	0.22
750 x 2400	460	11.0°	1.68	0.85	0.85	0.26	0.55	0.26	0.22
750 x 2600	460	10.0°	1.83	0.90	0.90	0.26	0.58	0.26	0.22
800 x 800	353	25.0°	0.58	0.31	0.31	0.20	0.20	0.20	0.17
800 x 1000	439	25.0°	0.73	0.48	0.48	0.26	0.26	0.26	0.24
800 x 1200	526	25.0°	0.88	0.69	0.69	0.33	0.33	0.33	0.31
800 x 1400	530	21.5°	1.04	0.76	0.76	0.33	0.54	0.33	0.30
800 x 1600	530	19.0°	1.19	0.82	0.82	0.33	0.58	0.33	0.30
800 x 1800	530	16.5°	1.34	0.89	0.89	0.33	0.61	0.33	0.29
800 x 2000	530	15.0°	1.50	0.95	0.95	0.33	0.64	0.33	0.29
800 x 2200	530	13.5°	1.65	1.01	1.01	0.33	0.67	0.33	0.29
800 x 2400	530	12.5°	1.80	1.08	1.08	0.33	0.70	0.33	0.29

* Note that this particular calculation of the The Free Area Smoke Ventilator in accordance with Approved Document B, Volume 2, Appendix D, Section 5.b, Diagram C7, figure a. is only a secondary alternative to the in the first place cited Aerodynamic Free (Aa) in accordance with BS EN 12101-2 under Section 5.a. Furthermore, the calculation in accordance to 5.d diagram C7, figure a. cannot take into consideration individual lining depths used in specific interior design cases, which may give further limitations to the values presented above.

Product Name	Model	Material	Weight
Product Code	Accessories	Dimensions	Lead Time
Manufacturer	Country of Origin	Warranty	Installation
Technical Drawing	Installation Manual	Product Literature	Customer Support
Product Description	Product Features	Product Benefits	Product Applications
Product Specifications	Product Certifications	Product Compliance	Product Safety
Product Performance	Product Reliability	Product Durability	Product Efficiency
Product Maintenance	Product Repairs	Product Replacement	Product Disposal
Product Installation	Product Removal	Product Refurbishment	Product Recycling
Product Accessories	Product Options	Product Customization	Product Personalization
Product Pricing	Product Discounts	Product Promotions	Product Financing
Product Shipping	Product Delivery	Product Tracking	Product Returns
Product Support	Product Training	Product Documentation	Product Feedback
Product Reviews	Product Ratings	Product Testimonials	Product Case Studies
Product News	Product Updates	Product Announcements	Product Press Releases
Product Events	Product Exhibitions	Product Conferences	Product Seminars
Product Partners	Product Suppliers	Product Distributors	Product Retailers
Product Competitors	Product Alternatives	Product Comparisons	Product Recommendations
Product Trends	Product Forecasts	Product Insights	Product Opportunities
Product Challenges	Product Solutions	Product Innovations	Product Developments
Product Risks	Product Mitigations	Product Opportunities	Product Threats
Product Strengths	Product Weaknesses	Product Opportunities	Product Threats
Product Opportunities	Product Threats	Product Opportunities	Product Threats

Skylight module

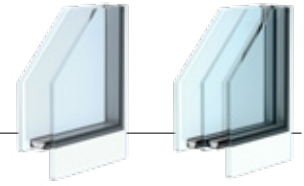





Table for country specific values





Additional ventilation characteristics HVC				Additional national smoke ventilation characteristics HVC-----AB					
Basic geometry data				Germany	Denmark	Belgium	Austria		Great Britain
Size of Skylights	Actuator chain stroke [mm]	Opening angle	Geometric area: Av [m ²] (EN 12101-2)	DIN 18232	DBI 027	NBN S21-208-3:2018	Guideline TRVB S 111 + addendum 3.3.2018 to point 5.4.		
				Geometric free area: A _g [m ²]	Cold smoke exhaust area: A _g [m ²]	Geometric free area (A) in accordance with NBN S21-208-3:2018	The installation inclination of the module is smaller than the opening angle of the sash relative to horizontal, i.e. the sash raises above horizontal in fully opened position.	The installation inclination of the module is larger than the opening angle of the sash relative to horizontal, i.e. the sash remains below or raises maximum up to horizontal in fully opened position	The Free Area Smoke Ventilator in accordance with Approved Document B, Volume 2, Appendix D, Section 5.b, Diagram C7, figure a.
						Geometric area: A _g [m ²]		Area (A) [m ²] *	
900 x 800	353	25.0°	0.65	0.34	0.34	0.22	0.22	0.22	0.20
900 x 1000	439	25.0°	0.83	0.52	0.52	0.30	0.30	0.30	0.27
900 x 1200	526	25.0°	1.00	0.73	0.73	0.37	0.37	0.37	0.35
900 x 1400	610	24.5°	1.17	0.98	0.98	0.44	0.71	0.44	0.42
900 x 1600	610	21.5°	1.35	1.05	1.05	0.44	0.75	0.44	0.41
900 x 1800	610	19.0°	1.52	1.13	1.13	0.44	0.79	0.44	0.41
900 x 2000	610	17.0°	1.69	1.21	1.21	0.44	0.83	0.44	0.40
900 x 2200	610	16.0°	1.86	1.29	1.29	0.44	0.87	0.44	0.40
900 x 2400	610	14.5°	2.04	1.37	1.37	0.44	0.91	0.44	0.40
1000 x 800	353	25.0°	0.73	0.36	0.36	0.25	0.25	0.25	0.22
1000 x 1000	439	25.0°	0.92	0.55	0.55	0.33	0.33	0.33	0.30
1000 x 1200	526	25.0°	1.11	0.77	0.77	0.41	0.59	0.41	0.39
1000 x 1400	610	25.0°	1.31	1.02	1.02	0.49	0.76	0.49	0.47
1000 x 1600	700	24.0°	1.50	1.32	1.32	0.58	0.95	0.58	0.56
1000 x 1800	700	22.0°	1.69	1.42	1.42	0.58	1.00	0.58	0.55
1000 x 2000	700	20.0°	1.89	1.51	1.51	0.58	1.05	0.58	0.55
1000 x 2200	700	18.0°	2.08	1.61	1.61	0.58	1.10	0.58	0.54
1000 x 2400	700	16.5°	2.27	1.71	1.71	0.58	1.14	0.58	0.54



* Note that this particular calculation of the The Free Area Smoke Ventilator in accordance with Approved Document B, Volume 2, Appendix D, Section 5.b, Diagram C7, figure a. is only a secondary alternative to the in the first place cited Aerodynamic Free (Aa) in accordance with BS EN 12101-2 under Section 5.a. Furthermore, the calculation in accordance to 5.d diagram C7, figure a. cannot take into consideration individual lining depths used in specific interior design cases, which may give further limitations to the values presented above.

Glazing unit



Coating options	Colour code	Explanation
LowE		Low-emissivity coating
Sun1		Light sun protection coating
Sun2		Enhanced sun protection coating









Glazing description	Colour code	Explanation	Characteristic bending strength
F		Float	45.0 N/mm ²
H		Toughened	120.0 N/mm ²
HS		Heat Strengthened	70.0 N/mm ²
Int		Fire protection gel	-

Gas description	Colour code
Argon	
Krypton	

Foil	Colour code	Explanation
Polyvinyl butyral (PVB)		Lamination foil between the sheets of the laminated glass



Example of glazing unit construction

Description, from outside - inside	
Glazing variant	IGU 16L
Construction	6H LowE - 14 Argon - 6HS - 14 Argon - 6.76F LowE (33.2)
Description	Visual colour description
6H	6 mm pane with toughened glass 
LowE	Low-emissivity coating 
14 Argon	14 mm Argon filled cavity 
6HS	6 mm pane with heat strengthened glass 
14 Argon	14 mm Argon filled cavity 
6.76F (33.2)	Laminated glass, 3 mm float – 2 x 0.38 PVB foil – 3 mm float 
LowE	Low-emissivity coating 
Description, from outside - inside	Visual colour description, from outside - inside
Construction colour code	6H LowE - 14 Argon - 6HS - 14 Argon - 6.76F LowE (33.2) 

Product Name	IGU 1000x1500	U-Value	0.80 (LowE)
Product Name	IGU 1000x1500	U-Value	0.80 (Sun1)
Product Name	IGU 1000x1500	U-Value	0.80 (Sun2)
Product Name	IGU 1000x1500	U-Value	0.80 (LowE)
Product Name	IGU 1000x1500	U-Value	0.80 (Sun1)
Product Name	IGU 1000x1500	U-Value	0.80 (Sun2)
Product Name	IGU 1000x1500	U-Value	0.80 (LowE)
Product Name	IGU 1000x1500	U-Value	0.80 (Sun1)
Product Name	IGU 1000x1500	U-Value	0.80 (Sun2)
Product Name	IGU 1000x1500	U-Value	0.80 (LowE)
Product Name	IGU 1000x1500	U-Value	0.80 (Sun1)
Product Name	IGU 1000x1500	U-Value	0.80 (Sun2)

Glazing unit

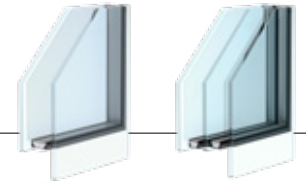

Glazing units						
		Double Glazing = DG		Triple Glazing = TG		
TG/ DG	Coating	Construction		Glass thickness	Visual colour description	
		IGU	Insulating Glass Unit (IGU)			Insulating Glass Unit (IGU)
		code	(outside - inside)			(outside - inside)
DG	LowE	10L	6H - 22 Argon - 6.76F LowE (33.2)	12		
DG	LowE	10T	8H - 16 Argon - 10.76F LowE (55.2)	18		
TG	LowE	16L	6H LowE - 14 Argon - 6HS - 14 Argon - 6.76F LowE (33.2)	18		
TG	LowE	16K	8H LowE - 12 Krypton - 4HS - 12 Krypton - 10.76HS LowE (55.2)	22		
TG	LowE	16T	8H LowE - 12 Argon - 4HS - 12 Argon - 10.76HS LowE (55.2)	22		
DG	Sun1	11L	6H Sun1 - 22 Argon - 6.76F (33.2)	12		
DG	Sun1	11T	8H Sun1 - 16 Argon - 10.76F (55.2)	18		
TG	Sun1	17L	6H Sun1 - 14 Argon - 6HS - 14 Argon - 6.76F LowE (33.2)	18		
TG	Sun1	17K	8H Sun1 - 12 Krypton - 4HS - 12 Krypton - 10.76HS LowE (55.2)	22		
TG	Sun1	17T	8H Sun1 - 12 Argon - 4HS - 12 Argon - 10.76HS LowE (55.2)	22		
DG	Sun2	12T	8H Sun2 - 16 Argon - 10.76F (55.2)	18		
TG	Sun2	18T	8H Sun2 - 12 Argon - 4HS - 12 Argon - 10.76HS LowE (55.2)	22		

Fire resistant glazing units used in fire resistant modules HFS						
TG/ DG	Coating	Construction		Glass thickness	Visual colour description	
		IGU	Insulating Glass Unit (IGU)			Insulating Glass Unit (IGU)
		code	(outside - inside)			(outside - inside)
TG	LowE	10U	6H LowE - 9 Krypton - 5H - Int.6 - 8.76F (44.2)			
TG	Sun1	11U	6H Sun1 - 9 Krypton - 5H - Int.6 - 8.76F (44.2)			
TG	Sun2	12U	6H Sun2 - 9 Krypton - 5H - Int.6 - 8.76F (44.2)			

Glazing unit

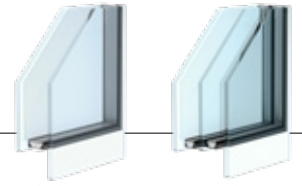

Glazing units																
Double glazing = DG / Triple glazing = TG	Coating	IGU code	Thermal transmittance U_g W/m ² K	Psi value ψ W/mK	Thermal transmittance of the entire window in accordance with EN 14351-1		Light transmittance τ_v %	Solar factor g %	UV transmittance τ_{uv} %	Colour rendering index R_a	Direct airborn sound reduction IGU R_w (C, C _{tr}) dB	Acoustic performance window ^{1), 2)} R_w (C, C _{tr}) dB	Rain noise L_{ia} dB	Total solar energy direct absorption a %	Resistance to pendulum body impact Class Outside/Inside	Resistance to burglary Class Inside
					area > 2.3 m ²	area ≤ 2.3 m ²										
					U_w	U_w										
					W/m ² K	W/m ² K										
DG	LowE	10L	1.1	0.059	1.4	1.4	80	62	0.3	96	35 (-3;-7)	35 (-1;-5)	52	24	1C1/1B1	P2A
DG	LowE	10T	1.0	0.066	1.3	1.4	73	51	0.2	95	41 (-1;-4)	38 (-1;-4)	49	30	1C1/1B1	P2A
TG	LowE	16L	0.6	0.060	0.89	0.98	72	51	0.2	95	37 (-2;-6)	36 (-1;-4)	49	35	1C1/NPD/1B1	P2A
TG	LowE	16K	0.5	0.080	0.86/0.87 ³⁾	0.96/0.99 ³⁾	71	50	0.2	94	42 (-2;-6)	38 (-1;-4)	48	38	1C1/NPD/1B1	P2A
TG	LowE	16T	0.7	0.080	1.0	1.1	71	50	0.2	94	42 (-2;-6)	38 (-1;-4)	48	38	1C1/NPD/1B1	P2A
DG	Sun1	11L	1.1	0.059	1.4	1.4	50	27	0.1	91	35 (-3;-7)	35 (-1;-5)	52	39	1C1/1B1	P2A
DG	Sun1	11T	1.0	0.066	1.3	1.4	49	27	0.1	89	41 (-1;-4)	38 (-1;-4)	49	42	1C1/1B1	P2A
TG	Sun1	17L	0.6	0.060	0.89	0.98	45	25	0.1	89	37 (-2;-6)	36 (-1;-4)	49	42	1C1/NPD/1B1	P2A
TG	Sun1	17K	0.5	0.080	0.86/0.87 ³⁾	0.96/0.99 ³⁾	44	25	0.1	88	42 (-2;-6)	38 (-1;-4)	48	45	1C1/NPD/1B1	P2A
TG	Sun1	17T	0.7	0.080	1.0	1.1	44	25	0.1	88	42 (-2;-6)	38 (-1;-4)	48	45	1C1/NPD/1B1	P2A
DG	Sun2	12T	1.1	0.066	1.4	1.5	18	17	0.1	91	41 (-1;-4)	38 (-1;-4)	49	60	1C1/1B1	P2A
TG	Sun2	18T	0.7	0.080	1.0	1.1	16	14	0.1	90	42 (-2;-6)	38 (-1;-4)	48	62	1C1/NPD/1B1	P2A

Fire resistant glazing units used in fire resistant modules HFS											
Coating	IGU code	U_g W/m ² K	ψ W/mK	U_w Area > 2.3m ² W/m ² K	U_w Area ≤ 2.3m ² W/m ² K	τ_v %	g %	τ_{uv} %	R_a	a %	
											code
TG	LowE	10U	1.0	0.083	1.3	1.4	76	60	-	96	29
TG	Sun1	11U	1.0	0.083	1.3	1.4	65	40	-	92	37
TG	Sun2	12U	1.0	0.083	1.3	1.4	57	33	-	90	40

Notes:

¹⁾ For product sizes A ≤/ = 2.7 m². For product sizes of 2.7m² < A < 3.6 m², the sound insulation values must be deducted by 1 dB

²⁾ The R_w+C-value indicates the number of decibels by which a window will reduce apparent noise.

R_w+C is an adjustment factor to account for high frequency noise sources e.g. living activities (talking, music, radio, TV), railway traffic at medium to high speed, road traffic exceeding 80 km/h or a jet aircraft.

R_w+C_{tr} is an adjustment factor to account for low frequency noise sources e.g. urban road traffic or railway traffic at low speeds.

³⁾ HFC/HVC

General notes:

- It is up to the customer to verify the chosen fire resistant glazing unit against the project specific conditions following the national requirement.
- Production height for calculation of climatic load is from 0 to 300 metre above sea level.
- Modules higher than 2400 mm will be delivered with a T-pane.
- Other insulating glass units are available, contact your VELUX sales office for more details.

Under normal conditions the free vision through the glass in a HFS module will not be adversely affected.

The term normal conditions implies that the gel layer may not be allowed to reach temperatures below -10°C or above + 45°C.

Product name	VELUX Commercial	Accessories	VELUX Commercial
Product code	6000000000	Accessories code	6000000000
Product description	VELUX Commercial	Accessories description	VELUX Commercial
Product group	VELUX Commercial	Accessories group	VELUX Commercial
Product family	VELUX Commercial	Accessories family	VELUX Commercial
Product type	VELUX Commercial	Accessories type	VELUX Commercial
Product variant	VELUX Commercial	Accessories variant	VELUX Commercial
Product version	VELUX Commercial	Accessories version	VELUX Commercial
Product status	VELUX Commercial	Accessories status	VELUX Commercial
Product date	VELUX Commercial	Accessories date	VELUX Commercial
Product author	VELUX Commercial	Accessories author	VELUX Commercial
Product reviewer	VELUX Commercial	Accessories reviewer	VELUX Commercial
Product approver	VELUX Commercial	Accessories approver	VELUX Commercial
Product creator	VELUX Commercial	Accessories creator	VELUX Commercial
Product modifier	VELUX Commercial	Accessories modifier	VELUX Commercial
Product deleter	VELUX Commercial	Accessories deleter	VELUX Commercial
Product publisher	VELUX Commercial	Accessories publisher	VELUX Commercial
Product distributor	VELUX Commercial	Accessories distributor	VELUX Commercial
Product supplier	VELUX Commercial	Accessories supplier	VELUX Commercial
Product customer	VELUX Commercial	Accessories customer	VELUX Commercial
Product partner	VELUX Commercial	Accessories partner	VELUX Commercial
Product contact	VELUX Commercial	Accessories contact	VELUX Commercial
Product email	VELUX Commercial	Accessories email	VELUX Commercial
Product phone	VELUX Commercial	Accessories phone	VELUX Commercial
Product fax	VELUX Commercial	Accessories fax	VELUX Commercial
Product website	VELUX Commercial	Accessories website	VELUX Commercial

Glazing area

Calculation of glazing area

Nominal module size: $W \times (H + 62 \text{ mm}) \text{ m}^2$

Visible glazing area: $(W - (2 \times 44 \text{ mm})) \times (H - (2 \times 44 \text{ mm})) \text{ m}^2$

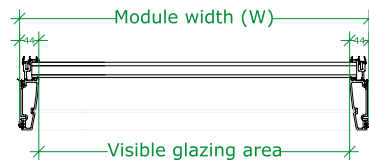
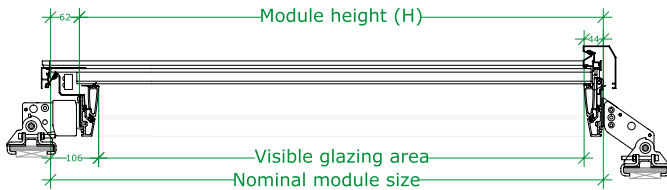

Frame & sash

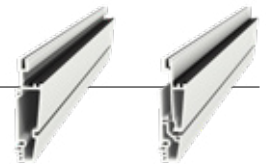

Frame and Sash

Material	Pultruded composite (approx. 80% fibreglass and 20% polyurethane)
Material thickness	3-4 mm
Surface coating	Waterbased white coating
Colour	RAL 9010, gloss 30

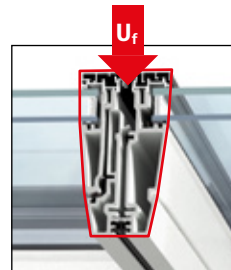

Thermal transmittance of the frame profiles (U_f)

U_f ¹⁾ [W/m²K]

Double-glazed	Triple-glazed
1.40	1.25

¹⁾ Calculated in accordance to EN ISO 10077-2:2012 and refers to the joint profiles when modules are combined.

Cladding & flashing



Cladding

Material	Aluminium
Material thickness	1.5 mm
Surface	Scratch resistant powder lacquer (60-120 my)
Colour	Noir 2100 Sable

Flashing

Flashing material	Aluminium
Material thickness	1 mm
Surface	Front: PVdf lacquer Back: polyamid polyester lacquer
Colour	Front: NCS standard colour: S 7500-N (RAL 7043)
Insulation material	EPS
Material thickness	10 mm
Wind and snow stop	Polyurethane foam

Frame & sash – interior colours

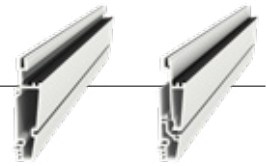

Standard colours



Frame and Sash **White**

Material: Pultruded composite (approx. 80% fibreglass and 20% polyurethane)
Surface: Waterbased white coating
Colour: RAL 9010, gloss 30

Semi-standard colours (Available at additional cost)

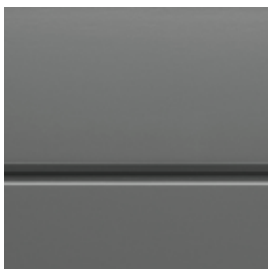

Frame and Sash **Light grey**

Material: Pultruded composite (approx. 80% fibreglass and 20% polyurethane)
Surface: Waterbased light grey coating
Colour: RAL 7037, gloss 30



Frame and Sash **Dark grey**

Material: Pultruded composite (approx. 80% fibreglass and 20% polyurethane)
Surface: Waterbased dark grey coating
Colour: RAL 7021, gloss 30



Frame and Sash **Black**

Material: Pultruded composite (approx. 80% fibreglass and 20% polyurethane)
Surface: Waterbased black coating
Colour: RAL 9005, gloss 30

Special colours



Special colours

All other colours can be ordered at additional cost.
Contact our sales team for more details.

Vapour barrier connection strip

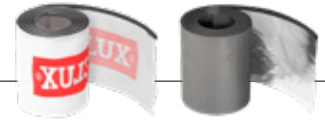

	BCX	BSX
Membrane	Polyethylene (PE-LD) 150 µm	Multilayer foil containing polyethylene and aluminium, 0.15 mm thick
Gasket	Welded EPDM rubber seal gasket	Welded EPDM rubber seal gasket
Height	200 mm	200 mm
Length	10,000 mm (10 m)	10,000 mm (10 m)
Classification	BCX is CE-marked in accordance with EN 13984	BSX is CE-marked in accordance with EN 13984
Resistance	Water vapour resistance Sd = 80 m	Water vapour resistance Sd = >1500 m
Reaction to fire	Class E	Class E

Chain actuator



Venting modular skylights and roller blinds can be powered and controlled from either a VELUX INTEGRA® or an Open system control system.

With VELUX INTEGRA® the actuator is powered and controlled with control unit KLC 410 and operated with a VELUX control pad. With Open system the actuator can be powered and controlled with either a ±24 V DC or a MotorLink™ control system.

VELUX INTEGRA® / Open system

Material	Anodised aluminium housing with zinc chromate passivated steel chain
Weight	Max 5.5 kg
Control system	VELUX INTEGRA®, MotorLink™ or ±24 V DC*
Supply cable	1.2 m grey silicone cable, 3 cord, 0.75 mm ² (white brown green**)
Chain stroke	HVC ----CB (comfort) 260 mm HVC ----AB (smoke and comfort) up to 700 mm (depending on module size)
Opening speed	HVC ----CB (comfort) 7 mm/s HVC ----AB (smoke and comfort) up to 13 mm/s
Sound level	32 dB (min speed)***
Holding force (tractive)	5000 N (burglary strength) min
Pressure force	1000 Newton* (smoke ventilation: 1300 Newton)
Tractive force	300-1000 Newton
IP rating	IPX4
Operation conditions	-15°C - +76°C, max. 90% relative humidity (not condensing)
Nominal voltage	24 V DC (max 10% ripple) ****
Voltage	19-32 V DC
Max voltage	32 V DC
Switch-on-duration	ED max 20% (2 minutes per 10 minutes)
Current consumption	HVC ----CB (comfort) max. 2A HVC ----AB (smoke and comfort) 2.5 - 5.5A depending on module size, glazing variant and required snow load
Service	It is recommended to carry out a function test of the actuator at least once a year and to make sure that the skylight opens correctly.
CE marking	The product is tested with the original WindowMaster control units and complies with the EMC directive's requirements for use in residential, commercial and light commercial buildings.
Reservation	The VELUX Group reserves the right to make technical changes.

Model	1000	1200	1400	1600	1800	2000	2200	2400	2600	2800
Weight [kg]	1.2	1.5	1.8	2.1	2.4	2.7	3.0	3.3	3.6	3.9
Max. cable length [m]	50	50	50	50	50	50	50	50	50	50
Max. current [A]	1.5	1.5	1.5	1.5	1.5	1.5	1.5	1.5	1.5	1.5
Max. voltage [V]	24	24	24	24	24	24	24	24	24	24
Max. stroke [mm]	260	260	260	260	260	260	260	260	260	260
Max. height [mm]	800	1000	1200	1400	1600	1800	2000	2200	2400	2600
Max. width [mm]	1000	1200	1400	1600	1800	2000	2200	2400	2600	2800
Max. depth [mm]	100	100	100	100	100	100	100	100	100	100
Max. weight [kg]	1.2	1.5	1.8	2.1	2.4	2.7	3.0	3.3	3.6	3.9
Max. height [mm]	800	1000	1200	1400	1600	1800	2000	2200	2400	2600
Max. width [mm]	1000	1200	1400	1600	1800	2000	2200	2400	2600	2800
Max. depth [mm]	100	100	100	100	100	100	100	100	100	100
Max. weight [kg]	1.2	1.5	1.8	2.1	2.4	2.7	3.0	3.3	3.6	3.9

Chain actuator



*At standard ± 24 V DC connection maximum distances from venting skylight to power supply in accordance to calculation:

$$\text{Max cable length} = \frac{(\text{admissible voltage drop (UL)} \times \text{conductivity of copper (56)} \times \text{cable cross-section (a)})}{(\text{total max. actuator current (I)} \text{ in amps} \times 2)}$$

At MotorLink™ (3 cord) connection maximum distances from roller blind to motor controller (power supply) is 50 m.

**Green = communication wire

*** The sound level can vary depending on the opening speed and building conditions

****The provided characteristics for Opening under load and related current consumptions on pages 82-85 are tested and valid for 24 V DC nominal voltage.

Preconditions for drive time for comfort ventilation with a smoke venting module	Maximum drive time for comfort ventilation (HVC ---AB)		
	Module height	Chain stroke [mm]	Drive time [sec]
<p>When using a smoke ventilation skylight module HVC AB for comfort ventilation, it must be ensured that the comfort opening is in accordance with the tables on pages 96-97 of the Technical Handbook.</p> <p>The chain stroke for comfort opening function must be limited accordingly by the control system time to maintain lifetime expectancy and guarantee of the modules, and for example can be done by limiting the drive time in most simple control setup.</p> <p>The provided drive times to the right are examples valid for the default strongest motor variant N1300.</p> <p>When a lower power consumption motor variant is configured and used, the chain will travel at a lower speed depending in the size of the module. Therefore, in these situations the appropriate drive time to reach the comfort opening must be established by the installer of the control system and set accordingly.</p> <p>The actuator is lifetime tested for comfort ventilation with a chain stroke up to 530 mm.</p>	800	260	20
	1000	260	20
	1200	260	20
	1400	260	20
	1600	260	20
	1800	260	20
	2000	260	20
	2200	260	20
	2400	260	20
	2600	260	20
	2800	260	20

Control system



Power supply and control unit KLC 410

Material and colour	Black fire resistant polycarbonate
Size and weight	Product including packaging: 587 mm x 80 mm x 166 mm (W x H x D) 2.0 kg Control unit: 380 mm x 36 mm x 87 mm (W x H x D) 1.5 kg
Installation	24 V DC SELV class III construction output. The control unit is for use in small/medium installations with VELUX Modular Skylights. The control unit can be installed under the flashing of VELUX Modular Skylights or inside the building, at a maximum cable distance of 20 m from the chain actuator. The control unit functions at temperatures between -15°C and +50°C. ta=40°C The control unit is equipped with a 2.2 m 2-core cable (2 x 1.5 mm ² H05VV-F) and plug for connection to the mains supply. Radio frequency range: 300 m range open field. Depending on the building construction, the indoor range is approximately 30 m.
IP rating	IPX4
Power supply characteristics	Primary side: 230/240 V AC - 50 Hz / 250W Secondary side: 24 V DC - 10 A class III construction output.
Connection	The control unit is only to be used with VELUX Modular Skylights and VELUX roller blinds RMM. The control unit can supply power to one venting skylight module and/or up to four roller blinds RMM. The connection wires are pre-fitted with wire-to-wire connectors. The connection wires to the chain actuator and the roller blinds RMM can be extended up to 20 m with a 2 x 1.5 mm ² cable.
Compatibility	KLC 410 is based on radio frequency (RF) technology and signals are transmitted in the 868 MHz range. It can be used with VELUX Modular Skylights chain actuator and roller blinds RMM. VELUX electrical products connected to KLC 410 can be operated by io-homecontrol® compatible activation controls.
CE marking	CE-marked to indicate that it is in accordance with the following EU directives: CPR, LVD, MD, RoHS, WEEE, R&TTE, Packaging waste directive and EMC for household, trade and light industry. Combinations of VELUX electrical products meet the requirements of above-mentioned directives.
Note	The VELUX Group reserves the right to make technical changes.



Control pad KLR 200

Material and colour	ABS, white (NCS S 1000-N), black (RAL 9005) and metallic grey
Size and weight	Product including packaging: 235 x 153 x 48 mm (W x H x D), 250 g Control pad: 95 x 95 x 23 mm (W x H x D), 180 g
Use	For indoor use, maximum ambient temperature 50°C Radio frequency range: 200 m range open field. Depending on the building construction, the indoor range is approximately 20 m Maximum number of products is 200*
Battery requirement	3 x Alkaline AA (1.5 V) batteries Expected battery lifetime: Approximately 1 year
Compatibility	Based on radio frequency (RF) technology, transmitted in 868 MHz range. Compatible with products with the io-homecontrol® logo. Can be used with all VELUX INTEGRA® and VELUX INTEGRA® Solar products.
CE marking	CE-marked to indicate that it is in accordance with the following EU directives: CPR, LVD, MD, RoHS, WEEE, R&TTE, Packaging waste directive and EMC for household, trade and light industry. Combinations of VELUX electrical products meet the requirements of above-mentioned directives.
Note	This product has been designed for use with genuine VELUX products. The connection to other products may cause damage or malfunction. The VELUX Group reserves the right to make technical changes.

* Maximum recommended number of products is 100 and for daily use it is 50.

Product	Part No.	Material	Weight
VELUX INTEGRA®	1000000000	Aluminum	0.5 kg
VELUX INTEGRA®	1000000001	Aluminum	0.5 kg
VELUX INTEGRA®	1000000002	Aluminum	0.5 kg
VELUX INTEGRA®	1000000003	Aluminum	0.5 kg
VELUX INTEGRA®	1000000004	Aluminum	0.5 kg
VELUX INTEGRA®	1000000005	Aluminum	0.5 kg
VELUX INTEGRA®	1000000006	Aluminum	0.5 kg
VELUX INTEGRA®	1000000007	Aluminum	0.5 kg
VELUX INTEGRA®	1000000008	Aluminum	0.5 kg
VELUX INTEGRA®	1000000009	Aluminum	0.5 kg
VELUX INTEGRA®	1000000010	Aluminum	0.5 kg

Roller blind



VELUX INTEGRA® and Open System

Materials (visible parts)	Fabric	Polyester
	Wire	Stainless steel
	Bottom rail	Anodized aluminium
	Top pulley wheels	Stainless steel
Colours (cloth)	Grey, white and black (silver on the backside of the black)	
Weight	Max 3.4 kg	
Installation	Please see installation instructions	
Combability	All VELUX Modular Skylights with VELUX INTEGRA® control system and ±24 V DC control systems	
Control system	VELUX INTEGRA® or ±24 V DC	
Supply cable	0.2 m cable, 2-core, 0.75 mm ² (white)	
RMM cable on skylight module*, ***	0.35 - 1.35 m cable, 3-core, 0.75 mm ² (white, brown, green**)	
Running speed	70 mm/sec.	
IP rating	IPX0	
Sound level	< 70 dB	
Operating conditions	-5°C - +75°C, max. 90% relative humidity (not condensing)	
Nominal voltage	24 V DC (max 10% ripple)	
Voltage	19-24 V DC	
Switch-on-duration	ED max 20% (2 minutes per 10 minutes)	
Electric current requirement	Max 1A	
Service	It is recommended to carry out a function test of the roller blind at least once a year and to make sure that the roller blind runs correctly.	
CE marking	The product is tested with genuine VELUX control units and a ±24 V DC control system and complies with the EMC directive's requirements for use in residential, commercial and light commercial buildings.	
UL approval	VELUX roller blind RMM is approved in accordance to UL 325, Door, Drapery, Gate, Louver, and Window Operators and Systems.	
Reservation	The VELUX Group reserves the right to make to technical changes.	

* For Open system ± 24 V DC connection, the maximum distance from roller blind to power supply is in accordance to the following calculation:

$$\text{Max. cable length} = \frac{\text{admissible voltage drop (UL)} \times \text{conductivity of copper (56)} \times \text{cable cross-section (a)}}{\text{total max. actuator current (I) in amps} \times 2}$$

** Green cable has no function

*** Only valid for pre-wired modules

Roller blind



Roller blind cloth properties

Colour	White (8806)	Grey (8805)	Black (8807)
--------	--------------	-------------	--------------

Radiation properties without glazing unit (%)

Light transmittance in visible light spectrum (τ_v)	36%	10%	1%
Light transmittance in full light spectrum (τ)	35%	22%	3%
Light reflectance in full light spectrum (ρ)	59%	45%	53%
Light absorption in full light spectrum (α)	6%	33%	44%

Reaction to Fire

Norm	Class
EN 13501-1 + A1	B, s1-d0
DIN 4202-1	B1
NF P 92 503 -507	M1

Roller blind effects on double-glazing unit (%)

Glazing variant	10L			11L			
	g-value	τ_v -value	Fc-value	g-value	τ_v -value	Fc-value	
Without RMM	62%	80%	100%	27%	50%	100%	
With RMM	White (8806)	34%	30%	58%	17%	20%	61%
	Grey (8805)	41%	8%	69%	21%	5%	75%
	Black (8807)	35%	1%	59%	18%	1%	64%

Roller blind effects on double-glazing unit (%)

Glazing variant	10T			11T			12T			
	g-value	τ_v -value	Fc-value	g-value	τ_v -value	Fc-value	g-value	τ_v -value	Fc-value	
Without RMM	51%	73%	100%	27%	49%	100%	17%	18%	100%	
With RMM	White (8806)	31%	27%	63%	17%	20%	61%	12%	8%	75%
	Grey (8805)	37%	7%	76%	21%	5%	75%	14%	2%	88%
	Black (8807)	32%	1%	65%	18%	1%	64%	12%	1%	75%

Product name	VELUX Commercial	Product code	109
Product description	Roller blind	Product category	Blinds
Product type	Roller blind	Product material	Aluminum
Product color	White	Product width	1000 mm
Product height	1500 mm	Product weight	1.5 kg
Product installation	Inside mount	Product warranty	5 years
Product compliance	EN 13363-2	Product certification	CE



Roller blind

Roller blind effects on triple-glazing unit (%)							
Glazing variant	16L			17L			
	g-value	τ_v -value	F _c -value	g-value	τ_v -value	F _c -value	
Without RMM	51%	72%	100%	25%	45%	100%	
With RMM	White (8806)	31%	27%	62%	16%	18%	64%
	Grey (8805)	37%	7%	74%	20%	5%	80%
	Black (8807)	33%	1%	66%	17%	1%	68%

Roller blind effects on triple-glazing unit (%)										
Glazing variant	16T / 16K			17T / 17K			18T			
	g-value	τ_v -value	F _c -value	g-value	τ_v -value	F _c -value	g-value	τ_v -value	F _c -value	
Without RMM	50%	71%	100%	25%	44%	100%	14%	16%	100%	
With RMM	White (8806)	32%	28%	64%	16%	19%	64%	11%	7%	79%
	Grey (8805)	38%	7%	76%	20%	5%	80%	12%	2%	86%
	Black (8807)	33%	1%	66%	17%	1%	68%	11%	1%	79%

g-value:

"The total transmitted fraction of the incident solar radiation consisting of direct transmitted solar radiation and the part of the absorbed solar radiation transferred by convection and thermal radiation to the internal environment."

(EN 13363-2)

"The fraction of the incident solar radiation that is totally transmitted by the glass." (EN 410)

The g-value (total solar energy transmittance) is a measure of how much solar energy is transmitted through the construction in the cooling period.

The g-value is defined as the ratio between the solar energy transmitted through the glazing and the incident solar factor on the glazing.

τ_v -value:

"The transmitted fraction of the incident solar radiation in the visible part of the solar spectrum, see EN 410."

(EN 13363-2)

"The fraction of incident light that is transmitted by the glass." (EN 410)

F_c-value:

"The shading factor, F_c-value, is the ratio of the solar factor of the combined glazing and solar protection device, g_{tot}, to that of the glazing alone, g. F_c=g_{tot}/g.

Note: in some countries, F_c is known as z." (EN 14501)

Beam for Ridgelight at 5°



Beam for Ridgelight at 5°		
	Horizontal beam with rectangular profile	Parallel beam with curved profile
Material	Steel	Steel
Material thickness	3 mm	4 mm
Construction	Hollow beam	Hollow beam
Surface	Powder coating, white RAL 9010, gloss 30	Powder coating, white RAL 9010, gloss 30
Foam gasket on beam	Grey 15 mm	Black 6 mm

Horizontal beam with rectangular profile

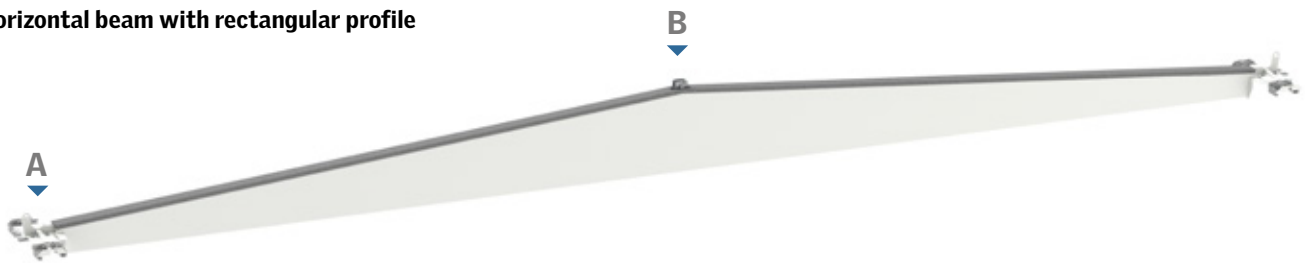

Parallel beam with curved profile

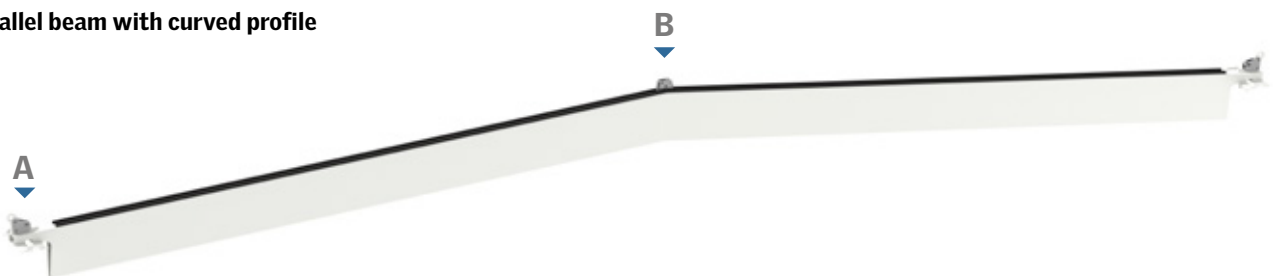

Product Name	Product Code	Product Description	Product Weight	Product Dimensions
VELUX Longlight	1000000000	1000 x 1000 x 100	1000	1000 x 1000 x 100
VELUX Northlight	1000000000	1000 x 1000 x 100	1000	1000 x 1000 x 100
VELUX Wall-mounted Longlight	1000000000	1000 x 1000 x 100	1000	1000 x 1000 x 100
VELUX Step Wall-mounted Longlight	1000000000	1000 x 1000 x 100	1000	1000 x 1000 x 100

Water pressure & drainage



Additional information on water pressure and drainage on a Step Wall-mounted Longlight

Please note that the same installation pitch is required on all rows and the maximum distance from the top of the vertical wall to the top of the lowest row of modules is 15 metres.

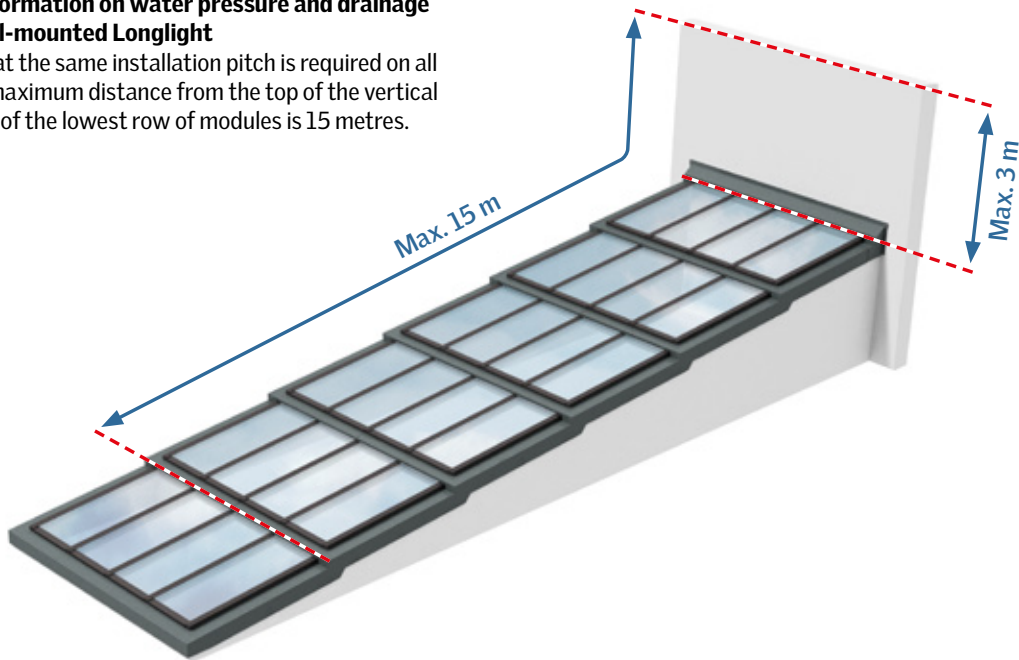

Additional information on water pressure and drainage on a Northlight

Please ensure max. 10 m distance above the skylight module, when installed in a sloping roof.

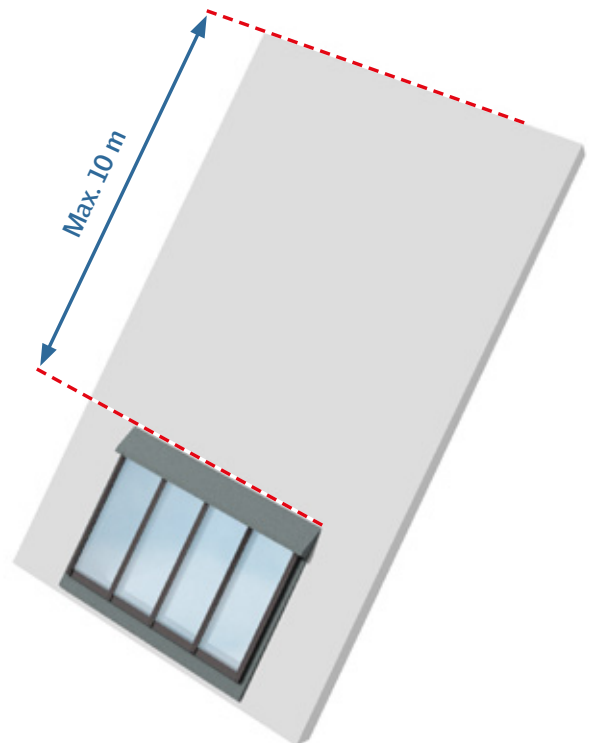

Additional information on water pressure and drainage on a Wall-mounted Longlight

Please ensure a max. 3 m wall height above skylight module.

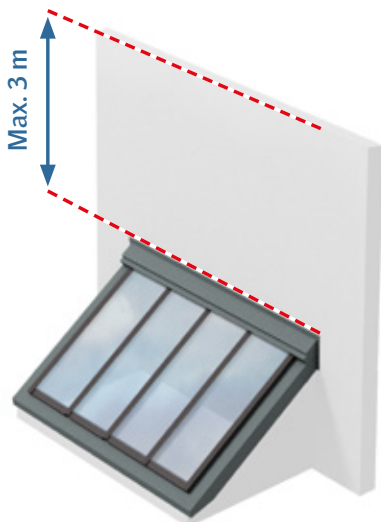

Resistance to wind load

Test method: EN 12211

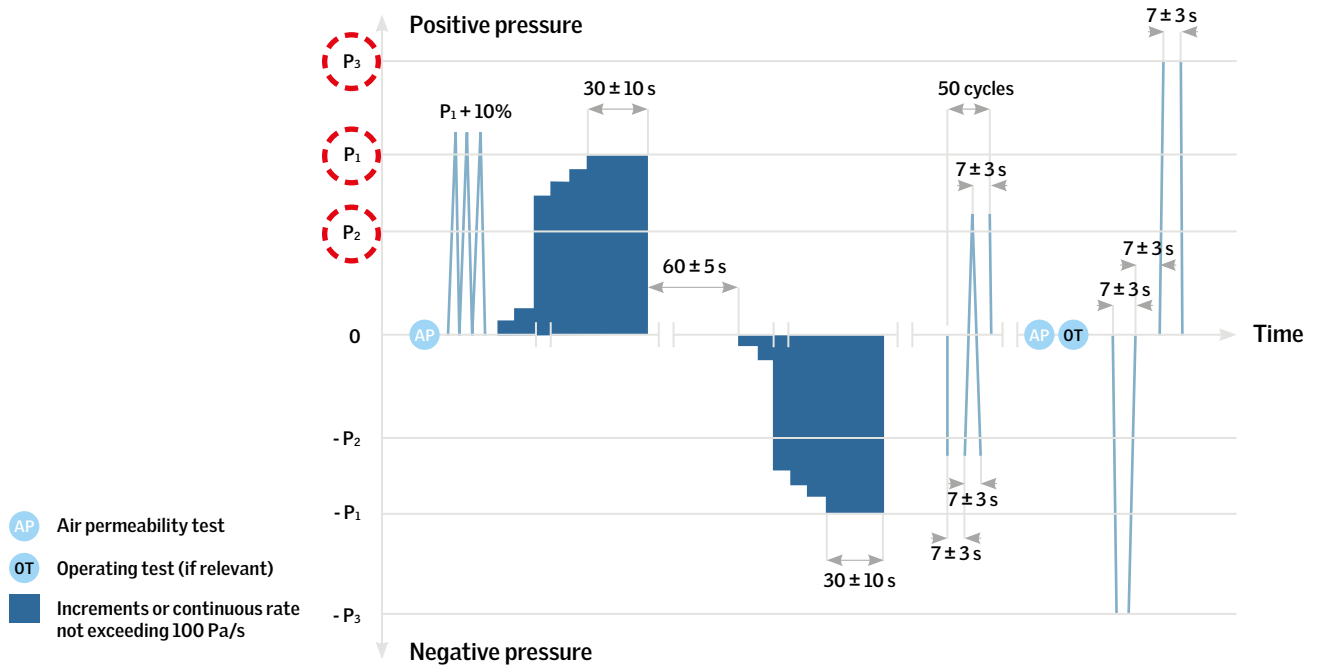

- VELUX Modular Skylights: Class C5 ***
- P₁ : 2000 Pa
- P₂ : 1000 Pa
- P₃ : 3000 Pa

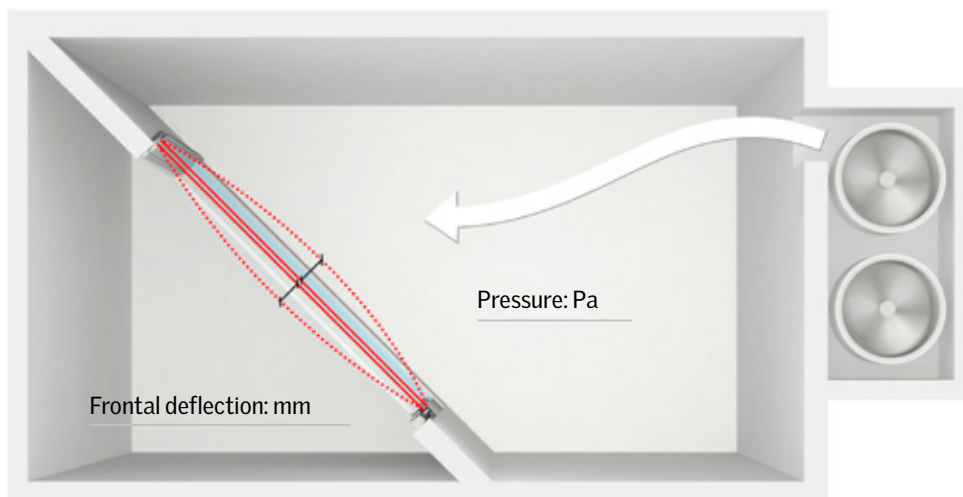

* Valid for sizes up to 1000 mm width and up to 2400 mm height, except HVC 100240 0010L/11L variants which has a classification of B4. Above these sizes the applicable performance is NPD.

Product Name	VELUX Modular Skylight	Accessories	VELUX Modular Skylight
Product Code	0010L/11L	Accessories Code	0010L/11L
Product Description	VELUX Modular Skylight	Accessories Description	VELUX Modular Skylight
Product Dimensions	1000x1000	Accessories Dimensions	1000x1000
Product Weight	1000	Accessories Weight	1000
Product Material	Aluminum	Accessories Material	Aluminum
Product Color	Black	Accessories Color	Black
Product Finish	Matte	Accessories Finish	Matte
Product Certification	EN 12210	Accessories Certification	EN 12210
Product Warranty	5 Years	Accessories Warranty	5 Years
Product Availability	In Stock	Accessories Availability	In Stock
Product Lead Time	2 Weeks	Accessories Lead Time	2 Weeks
Product Price	1000	Accessories Price	1000
Product Image		Accessories Image	



Resistance to wind load

Classification: EN 12210

Classification of wind load			
Class	P1	P2 ¹⁾	P3
0	-	not tested	-
1	400	200	600
2	800	400	1200
3	1200	600	1800
4	1600	800	2400
5	2000	1000	3000
Exxxx ²⁾	xxxx	-	-

¹⁾ Pressure repeated 50 times.

²⁾ Specimen tested with wind load above class 5, classified Exxxx – where xxxx is the actual test pressure P1 (e.g. 2350 etc.)

Classification of relative frontal deflection	
Class	Relative frontal deflection
A	< l/150
B	< l/200
C	< l/300

¹⁾ Pressure repeated 50 times.

²⁾ Specimen tested with wind load above class 5, classified Exxxx – where xxxx is the actual test pressure P1 (e.g. 2350 etc.)

Classification of resistance to wind load			
Wind load class	A	B	C
1	A1	B1	C1
2	A2	B2	C2
3	A3	B3	C3
4	A4	B4	C4
5	A5	B5	C5
Exxxx	Axxxx	Bxxxx	Cxxxx

Note: In resistance to wind load classification, the number refers to the wind load class, see table 1 and the letter to the relative frontal deflection, see table 2



VELUX Modular Skylights: Class C5 *

- Frontal deflection measured at P1: 2000 Pa is less than L/300.
 - 50 cycle pressure test P2: 1000 Pa
 - After that repeated air permeability test passed
- Safety test done at P3: 3000 Pa passed with no released part

* Valid for sizes up to 1000 mm width and up to 2400 mm height, except HVC 100240 0010L/11L variants which have Class B4. Above these sizes the applicable performance is NPD.

Reaction to fire



Test method: EN ISO 11925-2, EN 13823

Reaction to fire classes for building products (excl. floorings)							
Main class	Smoke class	Burning droplets class	Requirements according to			FIGRA	
			Non comb	SBI	Small flame	W/s	
A1	-	-	x	-	-	-	Non combustible
A2	s1 - s3	d0 - d2	x	x	-	≤ 120	
B	s1 - s3	d0 - d2	-	x	x	≤ 120	
C	s1 - s3	d0 - d2	-	x	x	≤ 250	
D	s1 - s3	d0 - d2	-	x	x	≤ 750	
E	-	- or d2	-	-	x	-	
F	-	-	-	-	-	-	No performance determined

¹⁾ The test is a corner basket test, which shows how much the product contributes to the development of fire.

Internal fire spread and smoke contribution.

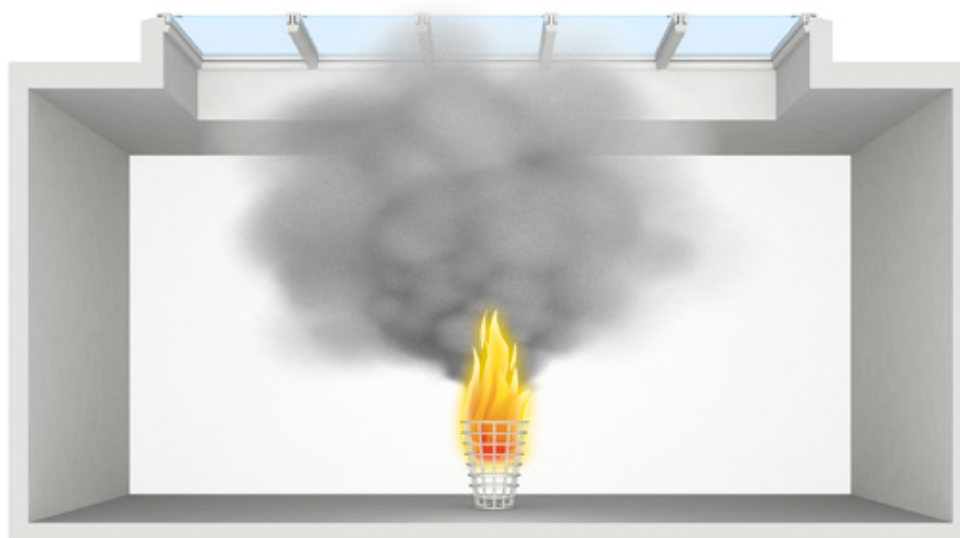

Resistance to fire



Test method: EN 1365-2

Fixed modules: EN 1365-2 Fire resistance tests for loadbearing elements - Part 2: Floors and roofs*

* In accordance with EN 1365-2, 1, which is the relevant standard for fixed modular skylights, roofs can be roof constructions incorporating glazed elements.

Under fire conditions, certain elements and windows can be required to remain satisfactory fire barriers depending on national and local requirements.

The tests assess how satisfactory fire barriers the modules are in the defined test conditions.

More simply, the tests assess the length of time the modules can effectively keep the fire inside the burning compartment.

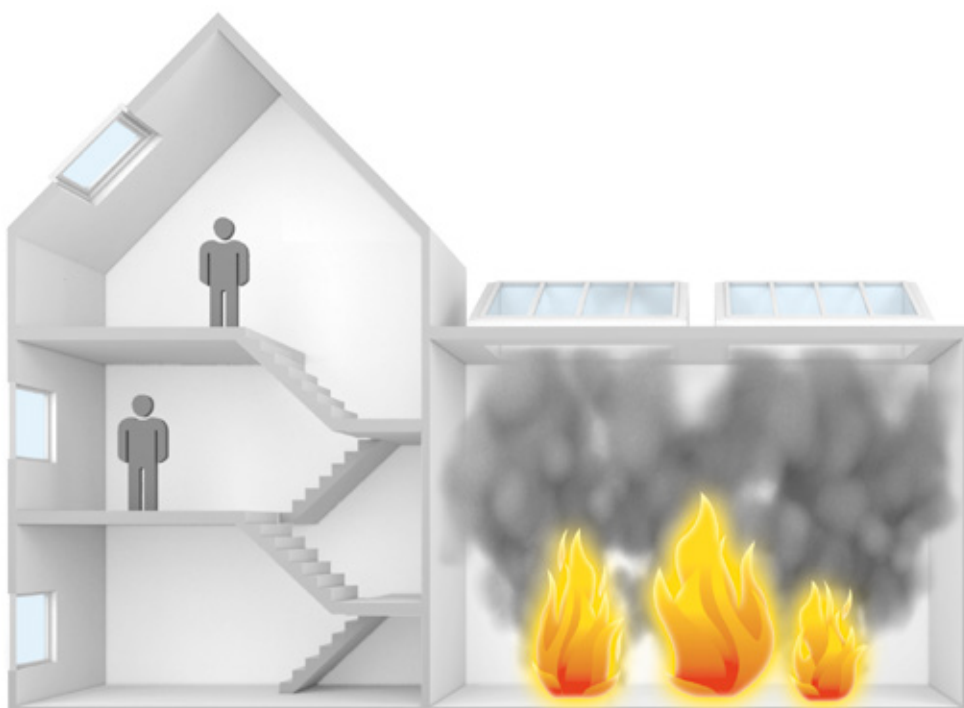

Temperature in the furnace

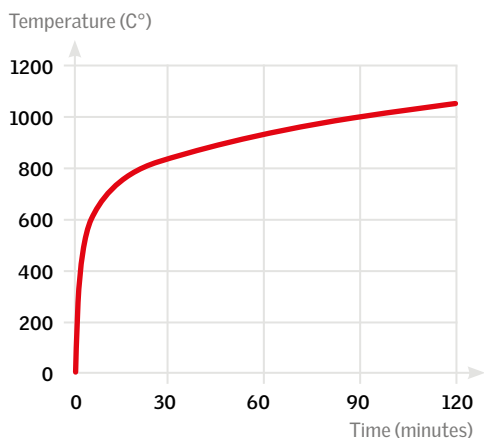

Modules on the furnace

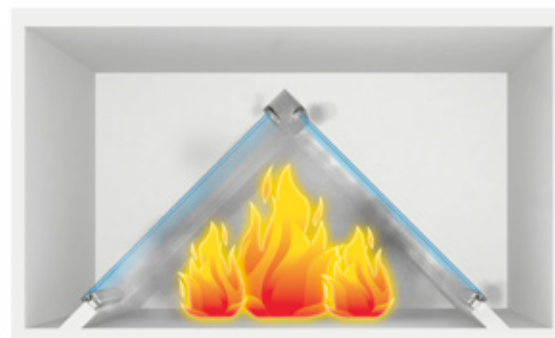

External fire performance



Test method: TS 1187 - External fire exposure to roofs*

* In accordance with EN 14351-1, TS1187 test methods T1 and T4 must be used to determine the external fire performance of roof windows.

The tests assess the fire spread across the external surface of the roof*, the fire spread within the roof*, the fire penetration and the production of falling droplets or debris falling from the underside of the roof*.

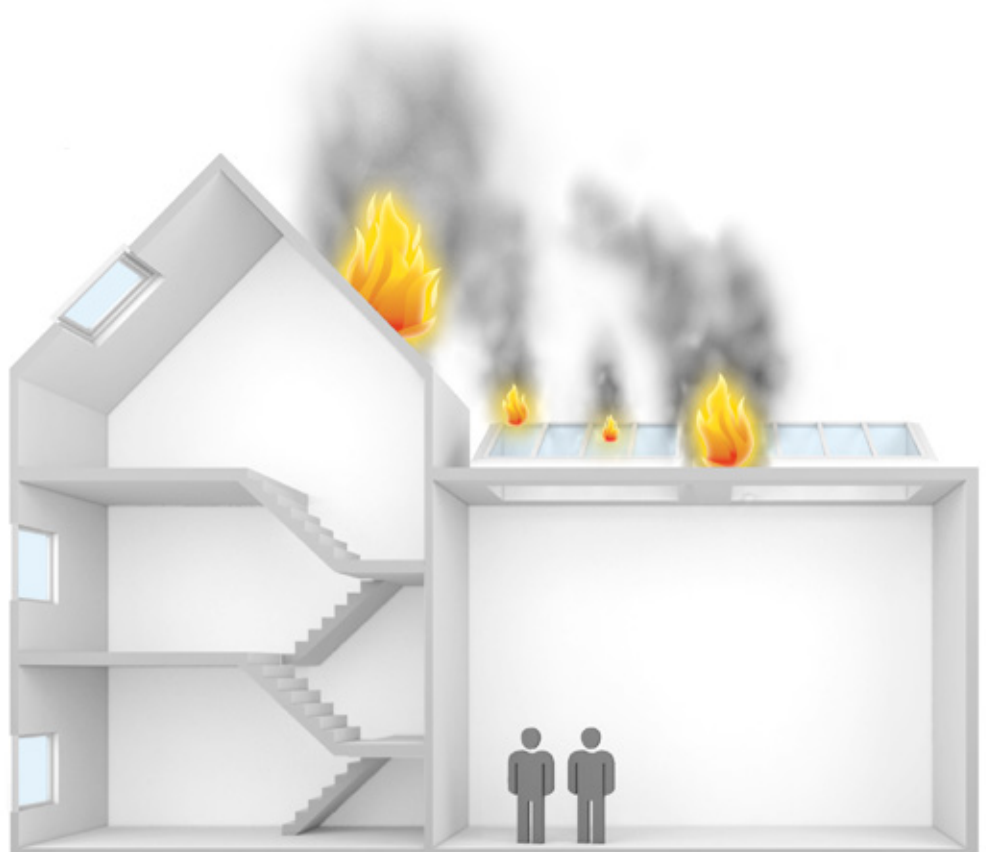

Test 1 – with burning brands



Test 4 - two stages incorporating burning brands, wind and supplementary radiant heat

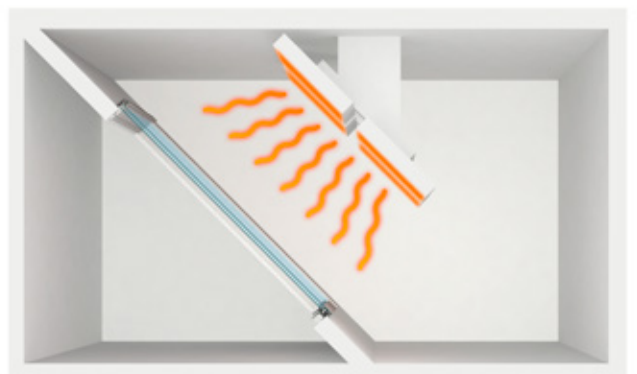

Product name	VELUX Modular Skylights	Product code	00000000000000000000
Product description	VELUX Modular Skylights	Product code	00000000000000000000
Product description	VELUX Modular Skylights	Product code	00000000000000000000
Product description	VELUX Modular Skylights	Product code	00000000000000000000
Product description	VELUX Modular Skylights	Product code	00000000000000000000
Product description	VELUX Modular Skylights	Product code	00000000000000000000
Product description	VELUX Modular Skylights	Product code	00000000000000000000
Product description	VELUX Modular Skylights	Product code	00000000000000000000
Product description	VELUX Modular Skylights	Product code	00000000000000000000
Product description	VELUX Modular Skylights	Product code	00000000000000000000



External fire performance

Classification: EN 13501-5 + A1

Test 1

Class	Classification criteria
B_{ROOF} (t1)	<p>All of the following conditions must be satisfied for all tests:</p> <ul style="list-style-type: none"> external and internal fire spread upwards < 0.700 m external and internal fire spread downwards < 0.600 m maximum burned length external and internal < 0.800 m no burning material (droplets or debris) falling from exposed side no burning/glowing particles penetrate the roof construction no single through opening > 25 mm² sum of all spread opening < 4500 mm² lateral fire spread does not reach the edges of the measuring zone no internal glowing combustion maximum radius of fire spread on flat roofs, external and internal < 0.200 m
F _{ROOF} (t1)	No performance determined.

Test 4

Class	Classification criteria
B_{ROOF} (t4)	<ul style="list-style-type: none"> No penetration of roof system within 1 h. In preliminary test, after withdrawal of the test flame, specimens burn for < 5 min. In preliminary test, flame spread < 0.38 m across region of burning.
C _{ROOF} (t4)	<ul style="list-style-type: none"> No penetration of roof system within 30 min. In preliminary test, after withdrawal of the test flame, specimens burn for < 5 min. In preliminary test, flame spread < 0.38 m across region of burning.
D _{ROOF} (t4)	<ul style="list-style-type: none"> Roof system is penetrated within 30 min but is not penetrated in the preliminary test. In preliminary test, after withdrawal of the test flame, specimens burn for < 5 min. In preliminary test, flame spread < 0.38 m across region of burning.
E _{ROOF} (t4)	<ul style="list-style-type: none"> Roof system is penetrated within 30 min but is not penetrated in the preliminary test. Flame spread is not controlled.
F _{ROOF} (t1)	No performance determined.



VELUX Modular Skylights

B_{ROOF} (t1)

B_{ROOF} (t4)

Watertightness

Test method: EN 1027

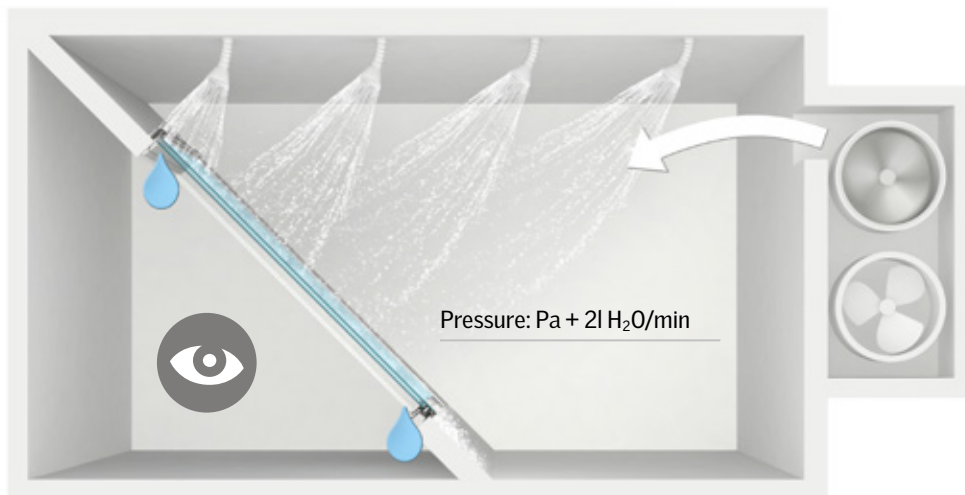
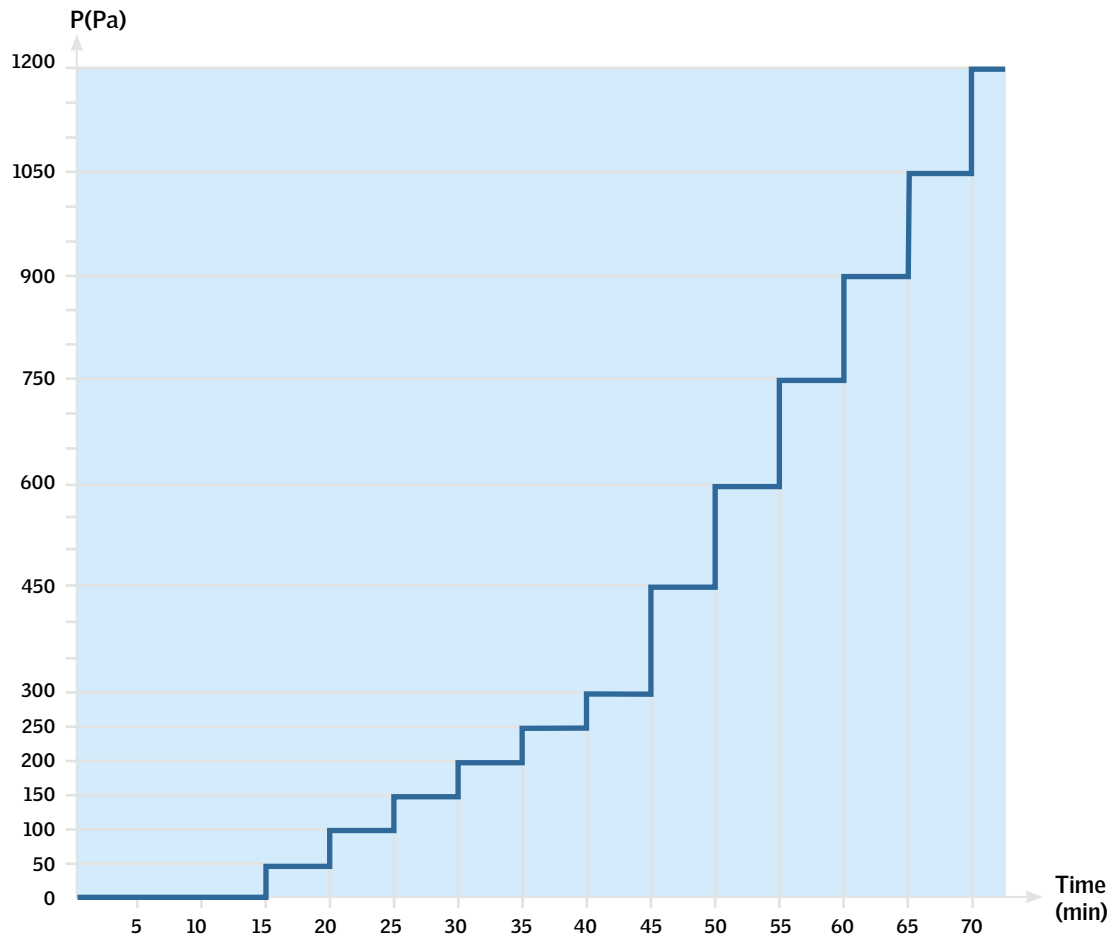

Product Name	VELUX Commercial Skylights	Product Code	00000000000000000000
Manufacturer	VELUX	Country of Origin	Denmark
Material	Aluminum	Weight	15 kg
Dimensions	1200 x 1200 mm	Installation Type	Flush Mount
Color	Black	Warranty	10 Years
Energy Rating	A	Energy Consumption	0 kWh/m²
Sound Rating	1	Sound Power Level	22 dB(A)
Light Transmittance	0.8	Light Loss Coefficient	0.05
U-Value	0.18 W/m²K	U-Value (with frame)	0.22 W/m²K
Water Resistance	E1200	Wind Resistance	155 km/h
Fire Rating	None	Fire Resistance	None
Acoustic Rating	1	Acoustic Coefficient	0.15
Installation	Flush Mount	Installation Manual	Available
Accessories	None	Accessories	None
Notes	Please refer to the technical drawing for detailed dimensions and installation instructions.		



Watertightness

Classification: EN 12208

Watertightness		
Classification	Pressure (Pa)	Wind (Km/h)
1 A	0	0
2 A	50	32
3 A	100	45
4 A	150	55*
5 A	200	63
6 A	250	71
7 A	300	78
8 A	450	95
9 A	600	110
E750	750	123**
E900	900	134
E1050	1050	145
E1200	1200	155

* Equal to depression

** Equal to tropical storm



VELUX Modular Skylights: E1200

No water penetration up to 1200 Pa.
1200 Pa equals 155 Km/h.

Air permeability

Test method: EN 1026

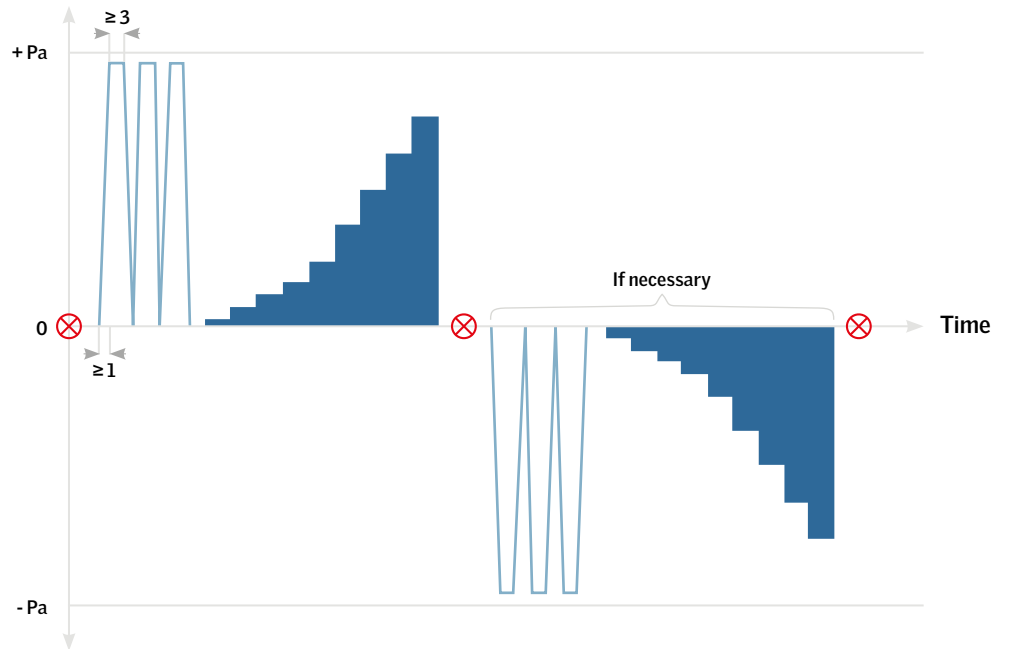

⊗ Opening and closing

Test pressure

- 150 Pa - Class 1
- 300 Pa - Class 2
- 600 Pa - Class 3, 4

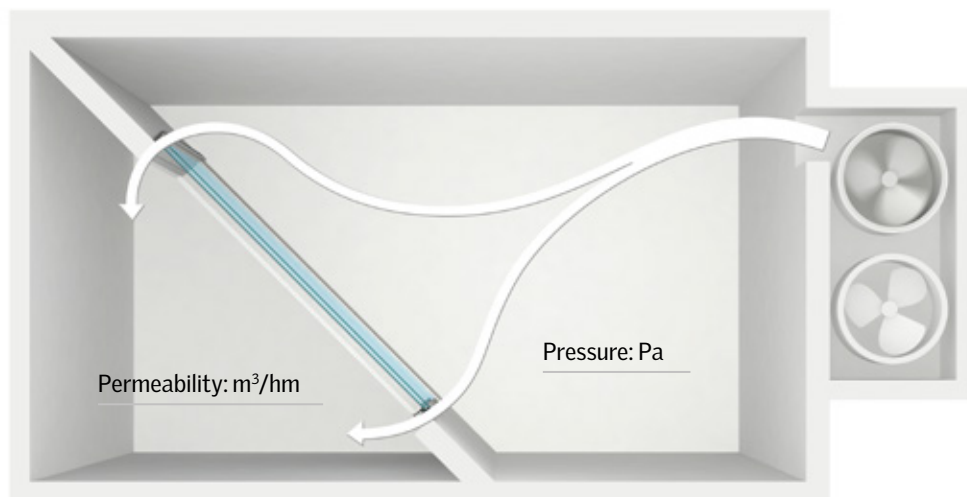

Product	Weight	Wind Load	Max. Glazing Area
VELUX Modular Skylights	100 kg/m²	± 0.5 kN/m²	100 m²
VELUX Modular Skylights	100 kg/m²	± 0.5 kN/m²	100 m²
VELUX Modular Skylights	100 kg/m²	± 0.5 kN/m²	100 m²
VELUX Modular Skylights	100 kg/m²	± 0.5 kN/m²	100 m²
VELUX Modular Skylights	100 kg/m²	± 0.5 kN/m²	100 m²
VELUX Modular Skylights	100 kg/m²	± 0.5 kN/m²	100 m²
VELUX Modular Skylights	100 kg/m²	± 0.5 kN/m²	100 m²
VELUX Modular Skylights	100 kg/m²	± 0.5 kN/m²	100 m²
VELUX Modular Skylights	100 kg/m²	± 0.5 kN/m²	100 m²
VELUX Modular Skylights	100 kg/m²	± 0.5 kN/m²	100 m²



Air permeability

Classification: EN 12207

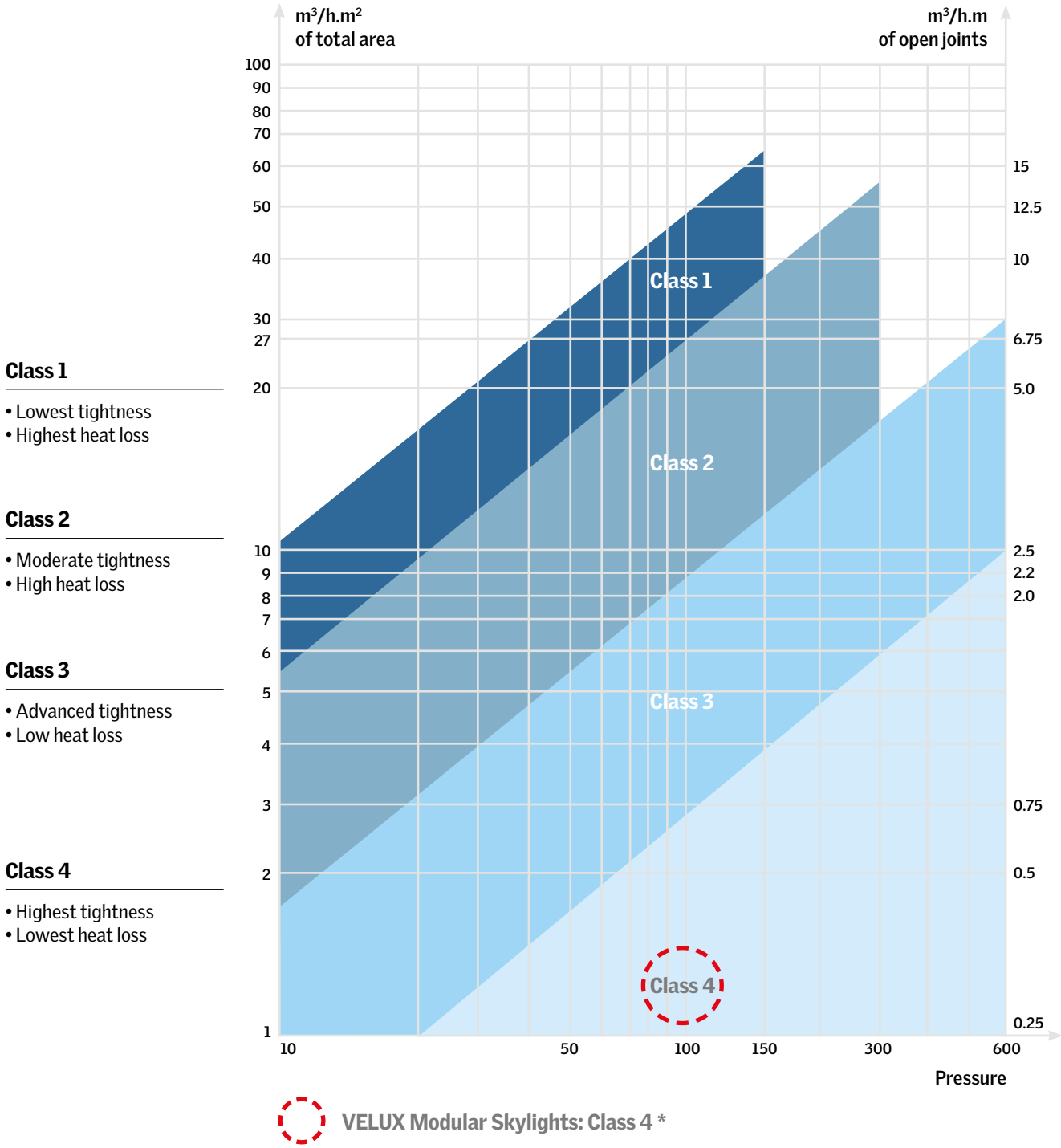

- Class 1**
- Lowest tightness
 - Highest heat loss
- Class 2**
- Moderate tightness
 - High heat loss
- Class 3**
- Advanced tightness
 - Low heat loss
- Class 4**
- Highest tightness
 - Lowest heat loss

 **VELUX Modular Skylights: Class 4 ***

* Except HVC 090220, HVC 090240, HVC 100220 and HVC 100240 with glazing variants 10L and 11L. For these classification is Class 3.

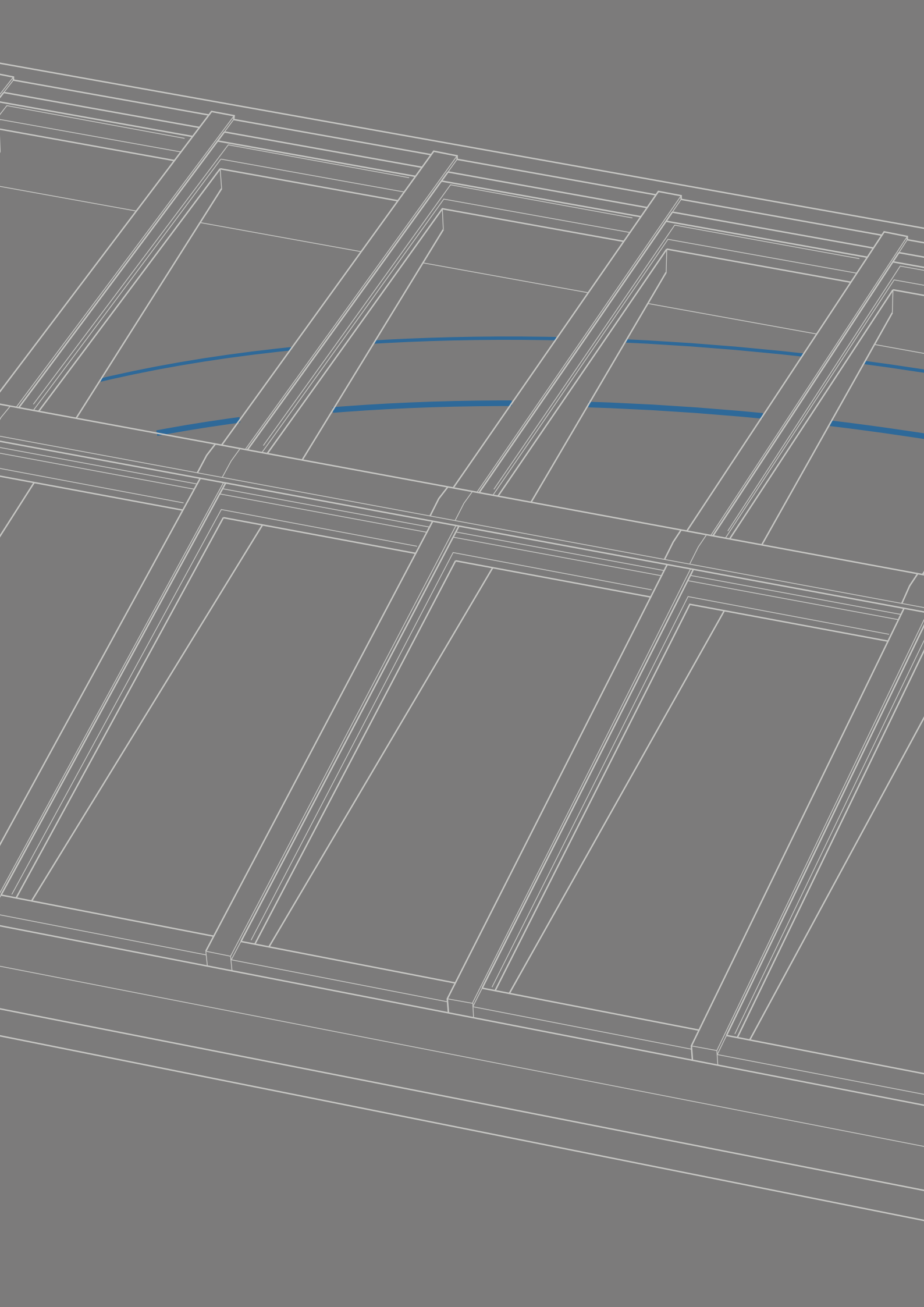



Additional Solutions

The following shown solutions for other types of skylight projects is project specific

Shaped solution with adaption of lining

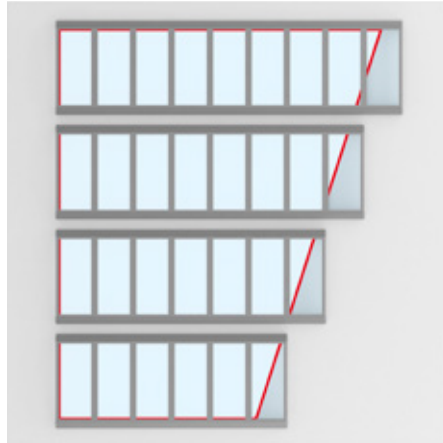

Atrium Longlight
 Internal lining
 Roof

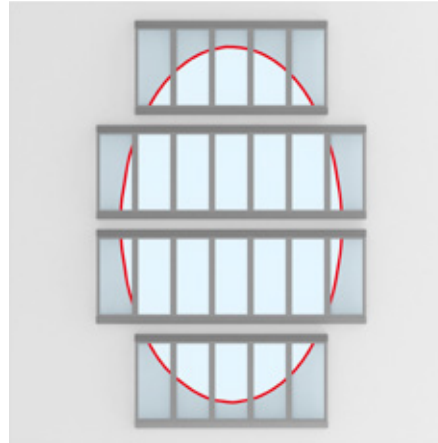

Atrium Longlight
 Internal lining
 Roof

Feature	Advantage	Benefit
By adapting the internal lining, it is possible to build a shaped skylight with standard skylight modules. *	By using standard skylight modules on non-square roof designs, the architects will not have to compromise the wishes for the interior design. The solution can be combined with venting modules and internal roller blinds.	Using standard products with standard installation principles gives high security in the design and building process. Installing venting modules and roller blinds gives a better indoor climate.

* If the modules are fitted with RMM, access from outside is mandatory.

Shaped solution with oval lining

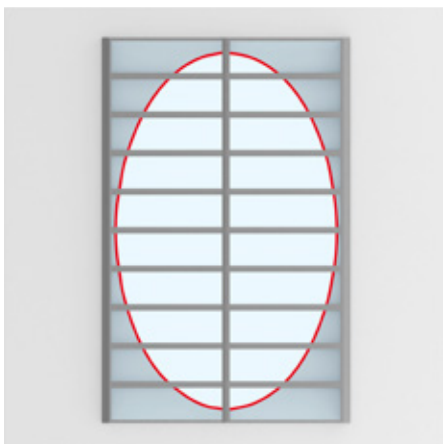

Ridgelight
 Internal lining
 Roof

Feature	Advantage	Benefit
By adapting the internal lining, it is possible to build a shaped skylight with standard skylight modules. *	By using standard skylight modules on non-square roof designs, the architects will not have to compromise the wishes for the interior design.	Using standard products with standard installation principles gives high security in the design and building process. The solution can be combined with internal roller blinds.

* If the modules are fitted with RMM, access from outside is mandatory.

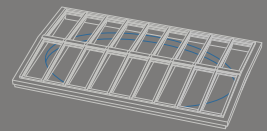

Asymmetric Ridgelight

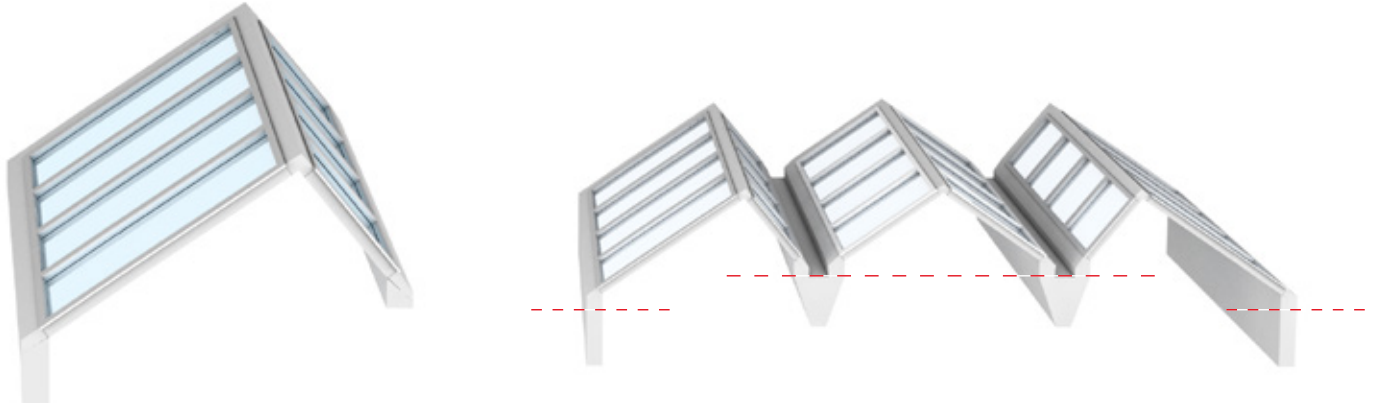

Feature	Advantage	Benefit
By constructing an asymmetric Ridgelight, it is possible to combine modules of different lengths in an installation.	The solution allows for installation between two roofs of different heights or of modules in different slopes. By combining panes with different characteristics on each side of the Ridgelight, it is possible to maximize daylight and minimize heat gain.	The asymmetric Ridgelight offers more flexibility in installations between buildings or sections of buildings.

Ridgelight on Girder



Feature	Advantage	Benefit
A Ridgelight solution that consists of two rows of VELUX Modular Skylights installed on one supporting horizontal girder at the ridge. The solution is delivered with a factory finished flashing designed for installation in pitches between 5-40°, either on a flat roof construction or at the top of a sloped roof. Girder and inner girder cover is not part of VELUX delivery.	<ul style="list-style-type: none"> The girder supports the installation and thus allows for increased installation pitch possibilities of the modules. Possibilities of vented modules on both sides. Possibilities of different glazing types on each side. 	<ul style="list-style-type: none"> Additional design options. Low pitch allows maximum daylight in the room. The large opening gives an illusion of a small glass roof.

Infill panel

Ventilation penetration

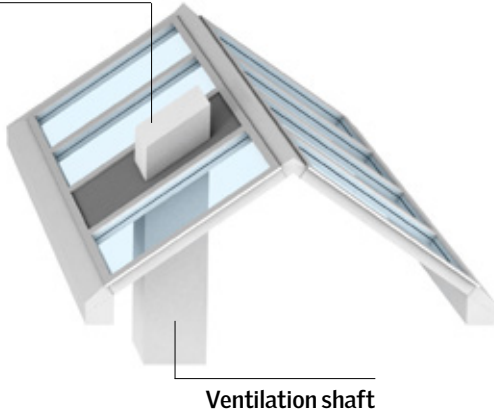

Infill panel

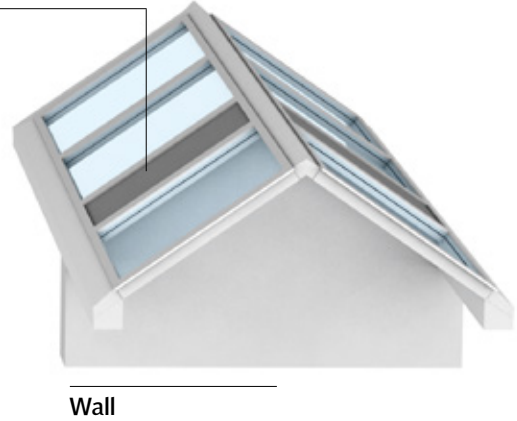

Feature	Advantage	Benefit
<p>Ventilation shaft: Use an infill panel when penetrating the skylight with e.g. ventilation.</p> <p>Wall: Use infill panels when covering a wall in the building.</p>	<p>Continuous modular skylight installations instead of disrupted installations.</p>	<p>Cheaper product solution and better design.</p>

Note:
 Products with a fixed, opaque insulating infill panel are out of the scope of the harmonised product standard EN 14351-1 used for CE marking of windows. No harmonised product standard is available/applicable for these products; they are not and cannot be CE-marked. The VELUX Group can deliver the above-mentioned products and provide product specifications on the relevant general performance characteristics for thermal transmittance, air permeability, watertightness, resistance to wind load and reaction to fire on request. The VELUX Group is not responsible for the specific application of the product with fixed, opaque insulating infill panel. It is the responsibility of the customer to verify the fitness of the product for specific use with the relevant authorities.

Skylight modules with photovoltaic glazing units

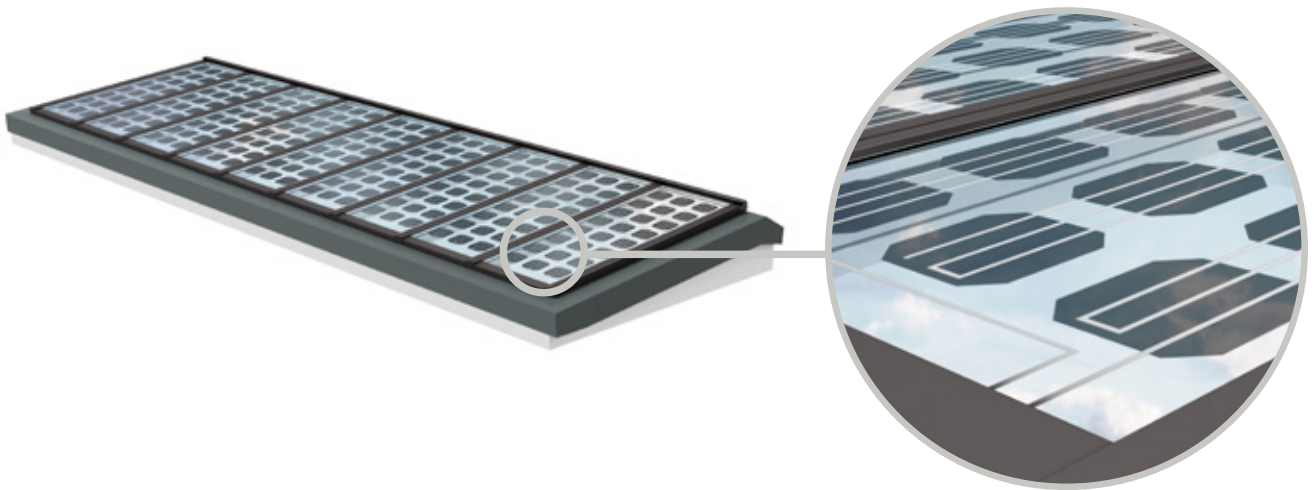

Feature	Advantage	Benefit
<p>VELUX Modular Skylights can be delivered with photovoltaic glazing units in both a fully covered or partly covered variant (illustration shows partly covered variant).</p>	<p>The solution offers a built-in solution where photovoltaic panels are combined with skylight installations.</p>	<p>The solution will optimize the utilization of space on the roof. Furthermore, the photovoltaic panels create a shadow effect in the building that reduces heat gain and glare.</p>

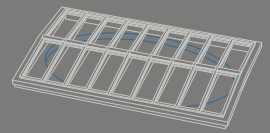

Sun screening – electrochrome glass



Glazing with electrochrome glass in clear state. Visible light transmission 57%



Glazing with electrochrome glass in intermediate state. Visible light transmission 15%

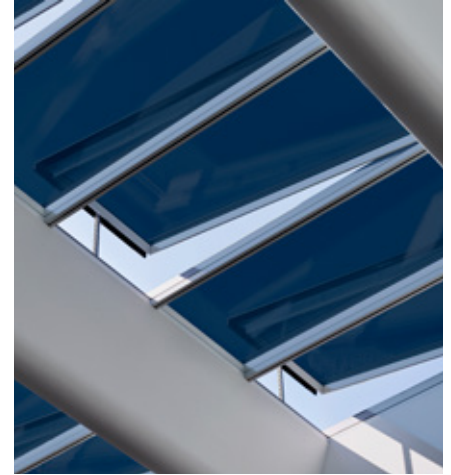

Glazing with electrochrome glass in fully tinted state. Visible light transmission 1%

VELUX Modular Skylights are available with electrochromic panes. The electrochromic pane is an insulated glazing unit with electronic, tintable coating. The coating can be darkened on demand by applying a low voltage of electricity. The dynamic changing in tint provides exceptional control of daylight, glare and energy use

without blinds or shades. An easy-to-use control system allows anyone to operate the electrochromic panes with wall switches, a mobile app or with a building management system. A combination of the three is also possible.

Sun screening – external awning blinds

Maintain a pleasant thermal indoor environment

The Topfix® VMS external awning blind by Renson protects the interior from excessive solar heating. The product is optimized for VELUX Modular Skylights and is applicable to both fixed and vent-

ing modules. Topfix® VMS operates on mounting feet that fits perfectly onto the external surface of the modular profiles. The blinds features a VELUX compatible operation system and can endure wind loads up to 120 km/h.



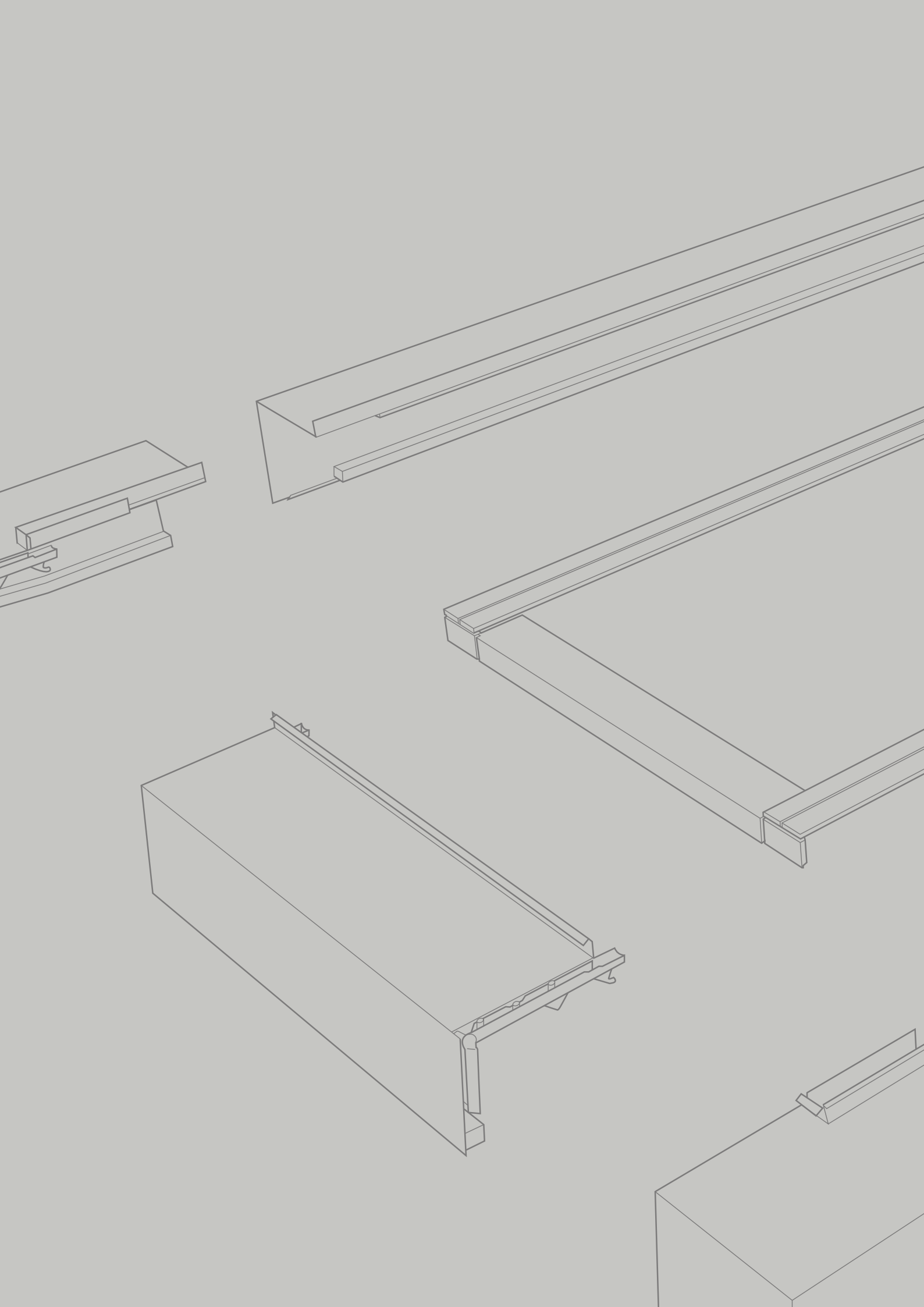

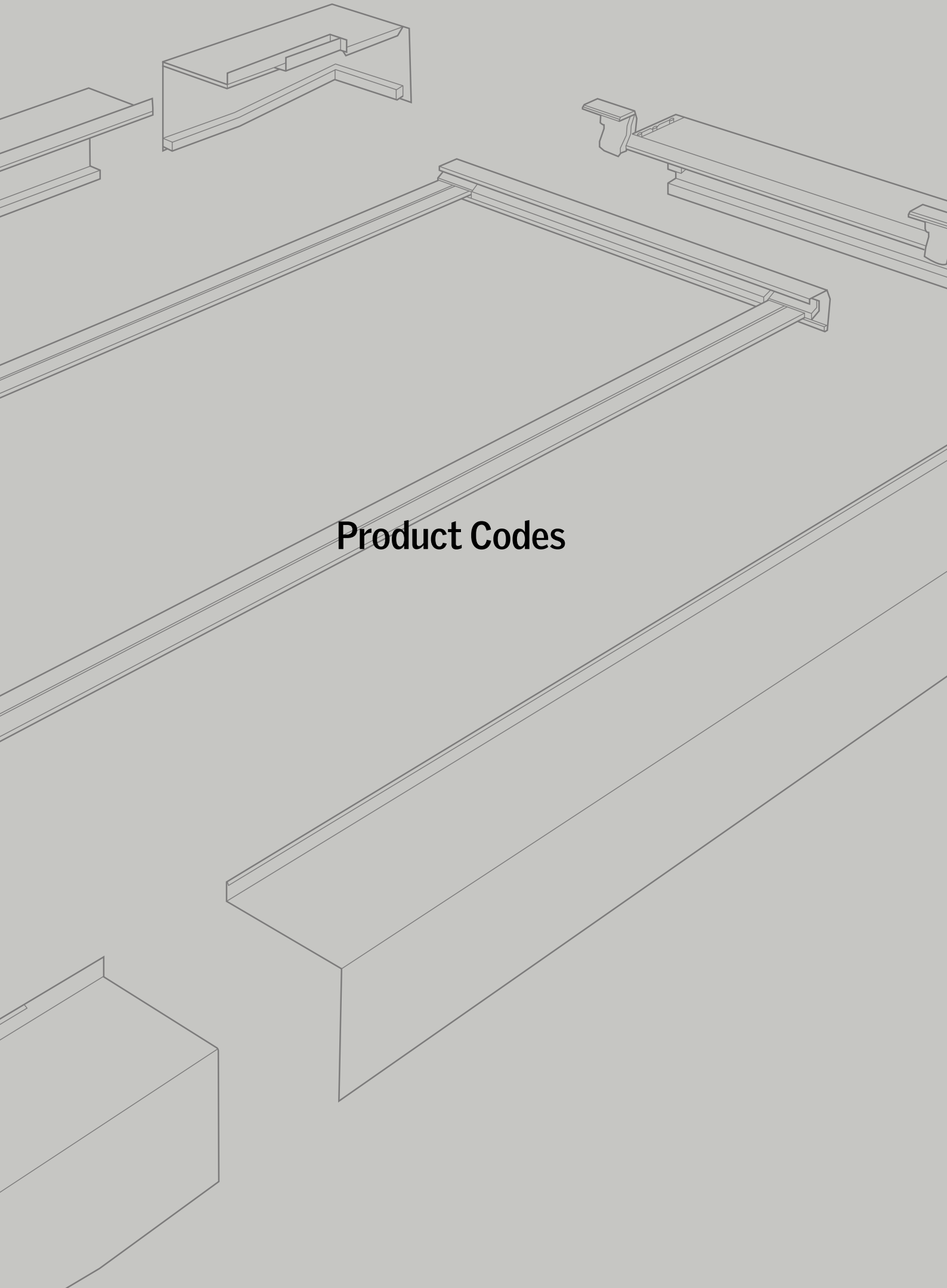

Product Codes

Modular Skylights – code structure



Example

HVC		067		160		0		0		10		T		C		B	
Type	Module width	Module height	Interior colour	Exterior colour	Glazing type	Glazing variant	Electric variant	Generation									
H = VMS	067 = 675 mm	120 = 1200 mm	0 = std.	0 = std.	10 = DGU/LowE	L = 3+3 mm inner glass	A = Open-system/Smoke										
	075 = 750 mm	140 = 1400 mm	RAL colour 9010, gloss 30	Noir 2100 Sable	11 = DGU/Sun1												
F = Fixed	080 = 800 mm	160 = 1600 mm			12 = DGU/Sun2	T = 5+5 mm inner glass	C = Open-system/Comfort										
V = Venting	090 = 900 mm	180 = 1800 mm			16 = TGU/LowE	K = Krypton gas instead of the standard Argon gas, 5 + 5 mm inner glass.											
	100 = 1000 mm	200 = 2000 mm	8 = Special	8 = Special													
C = Commercial market		220 = 2200 mm			17 = TGU/Sun1												
		240 = 2400 mm															
S = Fire-resistant variant. With fire resistant glazing unit and intumescent strip		260 = 2600 mm			18 = TGU/Sun2	U = Fire resistant											
		280 = 2800 mm															
		300 = 3000 mm															

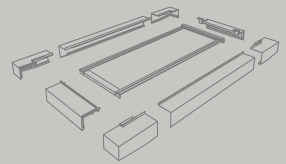

Roller blinds – code structure



Example

RMM	067	160	8805
Type	Module width	Module height	Fabric variant
R = Roller blind	067 = 675 mm	120 = 1200 mm	8805 = Grey, fire retardant
	075 = 750 mm	140 = 1400 mm	8806 = White, fire retardant
M = Electrical	080 = 800 mm	160 = 1600 mm	8807 = Black, fire retardant
	090 = 900 mm	180 = 1800 mm	
M = For VELUX Modular Skylights	100 = 1000 mm	200 = 2000 mm	
		220 = 2200 mm	
		240 = 2400 mm	
		260 = 2600 mm	
		280 = 2800 mm	
		300 = 3000 mm	

Product label – code structure



Product illustration

Module type Module size Colour variant

Pane type
Pane variant
Electrical variant
Generation
Order number

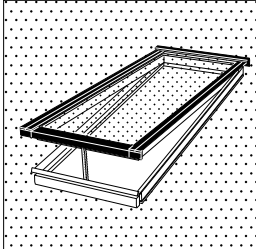

HVC 090180 0010 TCB

Vented Module

Width (W) x Height (H)
90 cm x 180 cm
Volume 0.27 m³
Weight 108 kg

(97)006008818863

(240)HVC 090180 0010

(95)5007156313(96)0020

HUSCOMPAGNIET - 29136802/Kim
Ring ved lev
ALDRSHVILEVEJ 153
DK-2450 KBH S

Made in Denmark by the VELUX Group

Product dimensions and weight EAN code Delivery address

Flashings – code structure

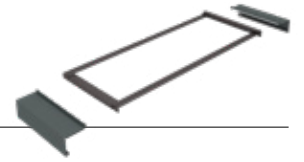

Longlight 5-30°

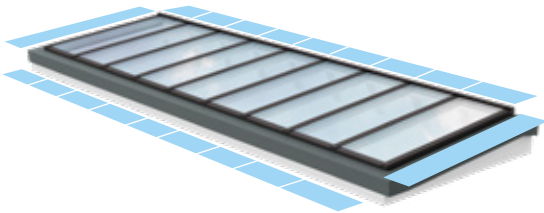

Ridgelight 25-40°

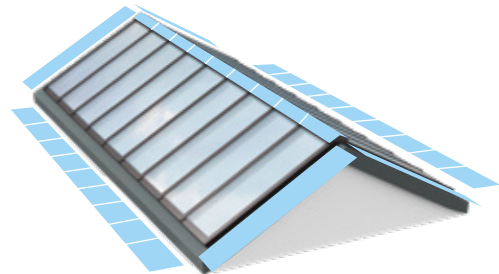

Wall-mounted Longlight 5-45°

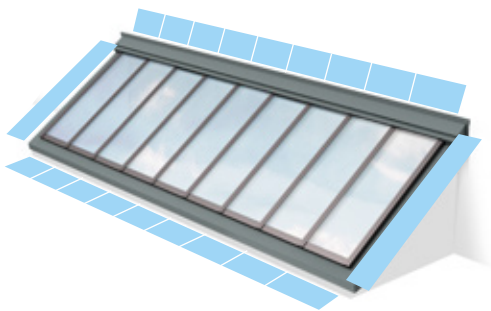

Ridgelight at 5° with Beams

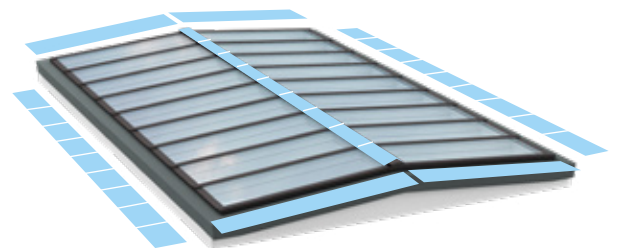

Northlight 25-90°

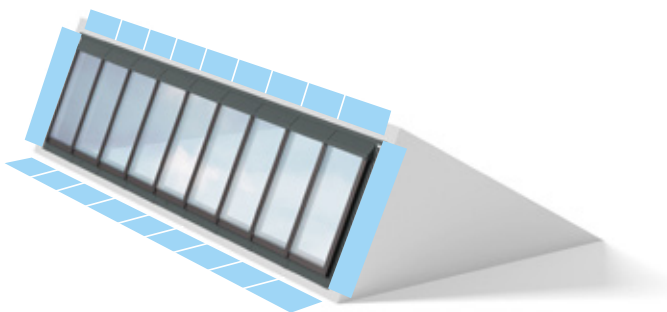

Step Longlight 5-25°

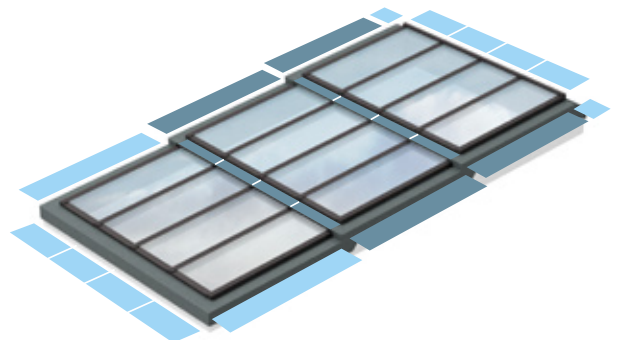

Code structure

 Flashing configuration

 Step solution extension flashing

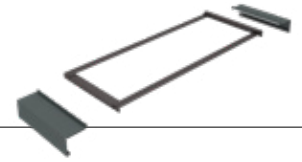
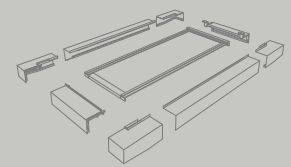

Flashing configuration – code structure

Example

ERC	080		160		0	0	0	25				D	B
Type	Module width		Module height		Interior	Exterior flashing	Exterior cladding	Installation pitch				VMS Cover	Gene-ration
E = Flashing	067 = 675 mm		120 = 1200 mm		0 = std.	0 = std.	0 = std.	05 = 5°, 10 = 10° etc.				D = Extra cover	
	075 = 750 mm		140 = 1400 mm		Only relevant on ERC: Beams and Inner ridge covering	NCS standard colour: S 7500-N (RAL 7043)	Noir 2100 Sable	Standard pitches:					
L = Longlight	080 = 800 mm		160 = 1600 mm					ELC	ERC	EWC	ENC	Extra Cover When HVC ≥ HFC	
R = Ridgelight	090 = 900 mm		180 = 1800 mm					05	05	05			
N = Northlight	100 = 1000 mm		200 = 2000 mm		10		10		1 pcs for ELC/ EWC/ ENC				
W = Wall-mounted Longlight			220 = 2200 mm		15		15						
			240 = 2400 mm		20		20		2 pcs for ERC				
C = Commercial Market			260 = 2600 mm		25	25	25						
			280 = 2800 mm		RAL colour 9010, gloss 30	8 = special	8 = special	30	30	25			
			300 = 3000 mm					35	35				
					8 = special			40	40	55			

VELUX Group
VELUX Commercial
Ådalsvej 99
2970 Hørsholm
Denmark

Email: vms@velux.com
Web: veluxcommercial.com
Blog: commercial.velux.com/blog

Bringing light to life

VELUX®

Commercial