

VELUX®

Commercial

VELUX Modular Skylights

Electrical Handbook

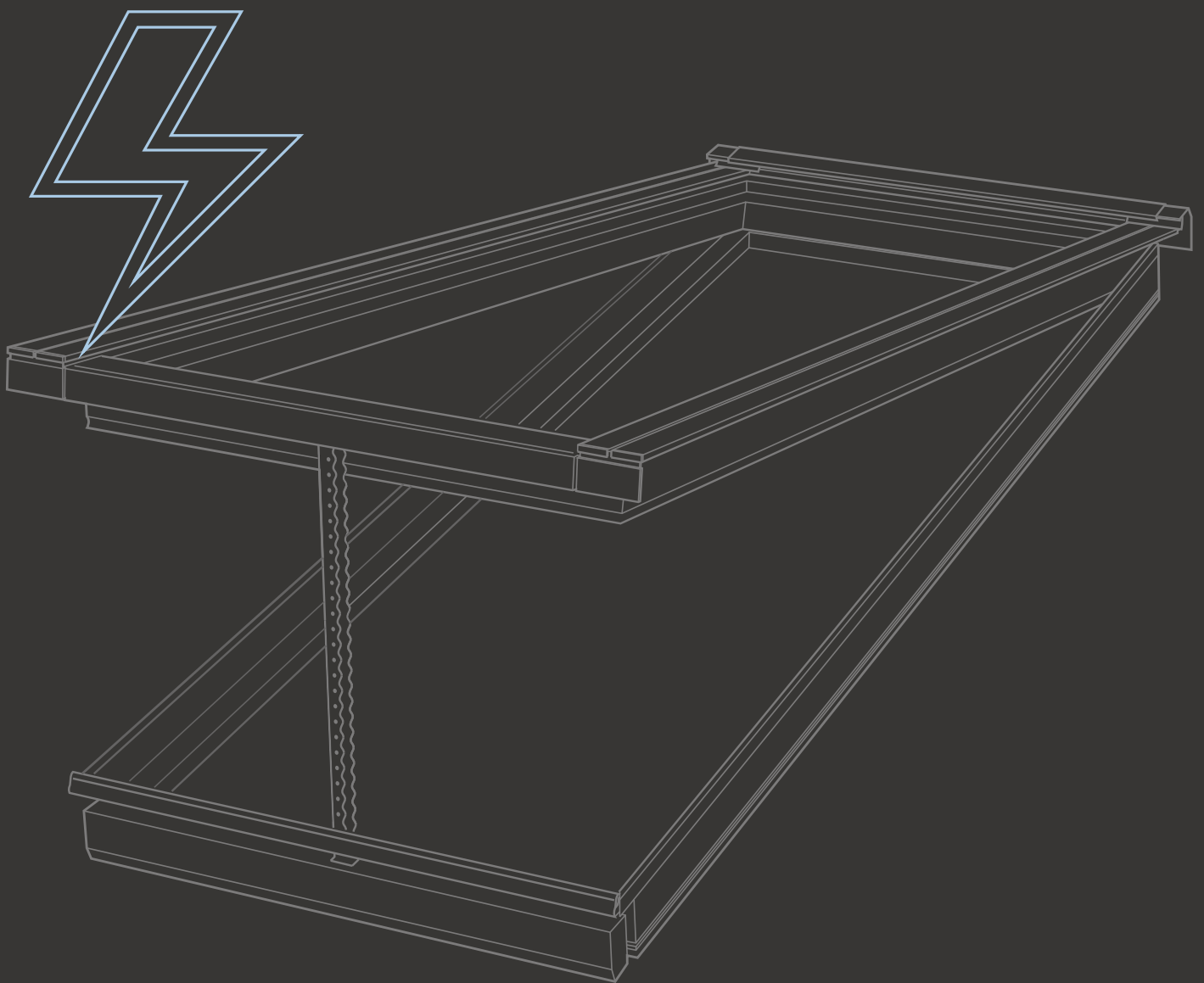



Ridgelight: Siemens Head Office, Ballerup, Denmark
Photographer: Laura Stamer





Controlling VELUX Modular Skylights

VELUX Modular Skylights and roller blinds offer two options of control, VELUX io-homecontrol® and an Open System solution. VELUX io-homecontrol® uses VELUX supplied operation devices to operate venting modules and roller blinds to any desired position.

Alternatively, the Modular Skylight system can be controlled with an Open System solution, connected to ± 24 V DC. Options include io-homecontrol® compatible systems and common building automation fieldbus systems.

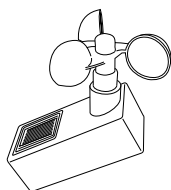
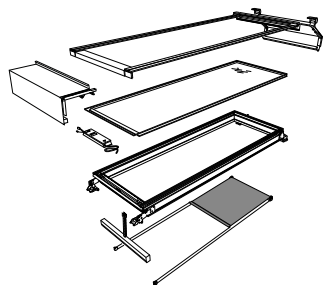

Planning & Specifying

7

Planning the electrical system	8
Ventilation	8
Wiring	9
Operators	9
Size of installation	9
Module – electrical components	10
Electrical components	11

VELUX io-homecontrol®

13

Chain actuator – VELUX io-homecontrol®	14
Power supply and control unit - KLC 410	15
Control pad – KLR 200	16
Control pad – KLR 300	17
Wall switches – KLI 311/312	18
Switch interface – KLF 050 (external wall switch)	19
Interface – KLF 200 (external control devices)	20
Rain sensor – KLA 200	21
Rain and wind sensor set – KLA S105	22
Roller blind – RMM	23
VELUX io-homecontrol® electrical diagrams	
Fixed modular skylights with sun screening	24
Fixed and venting modular skylights without sun screening	25
Fixed and venting modular skylights with sun screening	26

Open System

29

Comfort ventilation	
Chain actuator – comfort ventilation	30
Comfort ventilation electrical diagrams	
Comfort ventilation and sun screening with ±24V DC	34
Comfort ventilation and sun screening with advanced MotorLink™ control	35
Smoke ventilation	
Chain actuator – smoke ventilation	36
Smoke ventilation electrical diagrams	
Smoke ventilation with ±24V DC	38
Comfort and smoke ventilation with advanced MotorLink™ control	39
Roller blind RMM	40

Tips & Tricks

45

Combining VELUX io-homecontrol® and Open System	46
Recommended placement of rain and wind sensor	46
Wind deviation by building (side view)	47
Recommended placement of interface KLF 200 as repeater in VELUX io-homecontrol®	47
Placement of interface KLF 200 in complicated building layout	48
Reduction of IO signal	49

An exploded view diagram of a ceiling panel assembly. The diagram shows three main components: a top metal frame, a middle metal frame with a mounting bracket, and a bottom white rectangular panel. The components are arranged in a perspective view, showing their relative positions and how they fit together. The text "Planning & Specifying" is overlaid in the center of the diagram.

Planning & Specifying

Planning the electrical system

When planning the electrical system of your VELUX Modular Skylight installation, there are several things to consider.

You need to specify the functionality of the system, whether you have both venting modules and roller blinds or only one or the other, if there is a building management system already present, if you need smoke ventilation, how many users will operate and manage the system, how many sections it needs to be divided into, positioning and number of operation controls etc.

The electrical system for controlling the venting modules and the roller blinds can be supplied in two different systems, VELUX io-homecontrol® or the Open System $\pm 24V$ DC ($OS \pm 24V$ DC).

VELUX io-homecontrol® is a simple wireless system for control of comfort venting modules and/or roller blinds. All components for VELUX io-homecontrol® (actuators, control panels, sensors, etc.) are supplied by the VELUX Group. In the $OS \pm 24V$ DC, the actuators (opening motors and roller blinds) are controlled by $\pm 24V$ DC. In addition, the module actuator can be integrated in common building automation fieldbus systems, e.g. KNX, BACnet, LON and Modbus, through the integrated MotorLink™ technology. Connection to a fieldbus system requires a separate control box between fieldbus system and motor. For the $OS \pm 24V$ DC, only the actuators are supplied by the VELUX Group.

As both systems use the same actuator, the decision on which system to choose, can be postponed or changed at a later time.

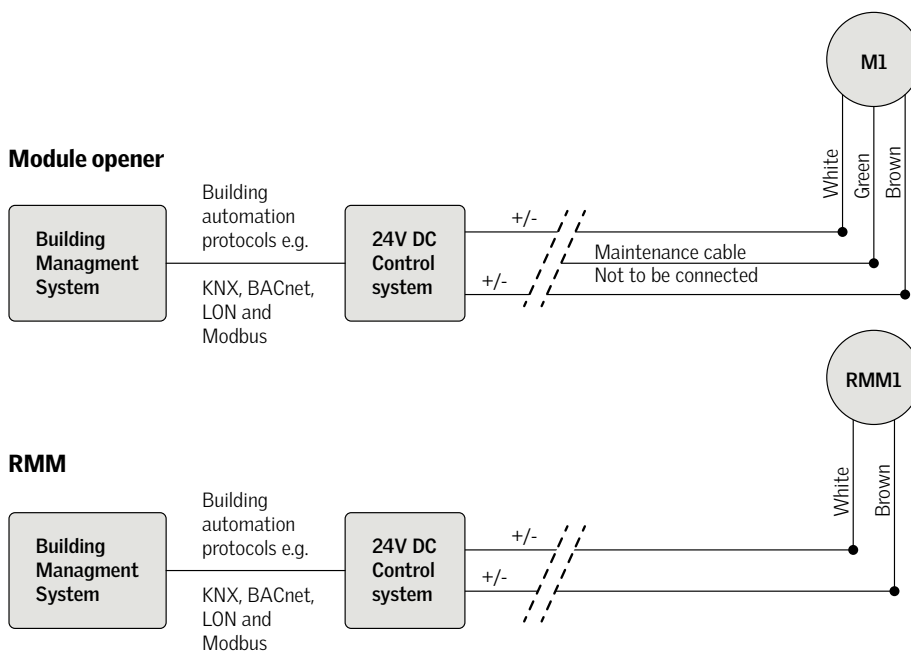

Ventilation

It is possible to use the venting modules for either smoke ventilation or comfort ventilation or both in combination. If only comfort ventilation is required, VELUX io-homecontrol® or $OS \pm 24V$ DC can be used. If smoke ventilation is required, only $OS \pm 24V$ DC can be used. The two systems can be combined if the customer wants to control

the venting modules centrally by a building management system and the roller blinds locally. A solution can then be to use $OS \pm 24V$ DC for operating venting modules and VELUX io-homecontrol® for roller blinds.

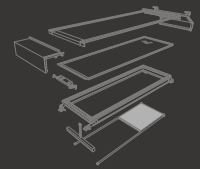

Wiring

In new build projects, wiring can and should be planned early on in the design phase of the project. When installing VELUX io-homecontrol® products, you only need to install standard 230V cabling to supply control unit KLC 410. If OS ±24V DC is selected, you need to design the ±24V cabling capacity to supply the actua-

tors according to the maximum power consumption needed. In renovation projects, wiring can be a challenge in existing constructions. In such cases VELUX io-homecontrol® could be preferable, as only 230V power cables need to be installed for each of the module actuators' power supply/control unit (KLC 410).

Operators

The choice between VELUX io-homecontrol® or Open System ±24V can be influenced by the use of the building:

Buildings with only few users, who are in the building on a regular basis (e.g. small offices and residential buildings), often have the need for multiple operators. In this case the VELUX io-homecontrol® system could be the optimal choice.

In buildings with many different people, who are not in the building on a regular basis (e.g. airports, shopping malls and other public buildings), the control should be centralised and with few instructed persons. In this case the OS ±24V DC is often the optimal choice.

Size of installation

Small installations (e.g. few skylights in the same area) will often require a simple standalone system like VELUX io-homecontrol®. Large installations (e.g. many different skylights on different roofs)

are likely to be integrated in a HVAC system (heat, ventilation and air condition) or a building management system, and the OS ±24V DC solution should be considered.

	VELUX io-homecontrol®	Open System
Advantages:	<ul style="list-style-type: none"> • Easy installation • High security (same encryption as ATMs) • Feedback on remote control • Wireless solution (only power is needed) • Supported by the VELUX Group • All components from same supplier • Runs with other/existing VELUX io-homecontrol® products in the building • Standalone control 	<ul style="list-style-type: none"> • Unlimited options depending on control system • Smoke ventilation option • Flexible choice of control systems • Centrally located power supply and control • Connection to existing control system • Configuration of system can easily be changed after installation
Limitations:	<ul style="list-style-type: none"> • Only comfort ventilation • Limited range of wireless connection • Maximum 200 products in one remote control * • Some building materials will cause a reduction of the IO signal 	<ul style="list-style-type: none"> • Installation and configuration require thorough planning • Not supported by the VELUX Group • Configuration only by certified technician

* KLR 200: For daily use, the recommended maximum number of products in one remote control is 50.
KLR 300: Maximum 99 of the same product type can be connected at once.

For more information about VELUX io-homecontrol® go to page 13 and about Open System go to page 29.

Module – electrical components

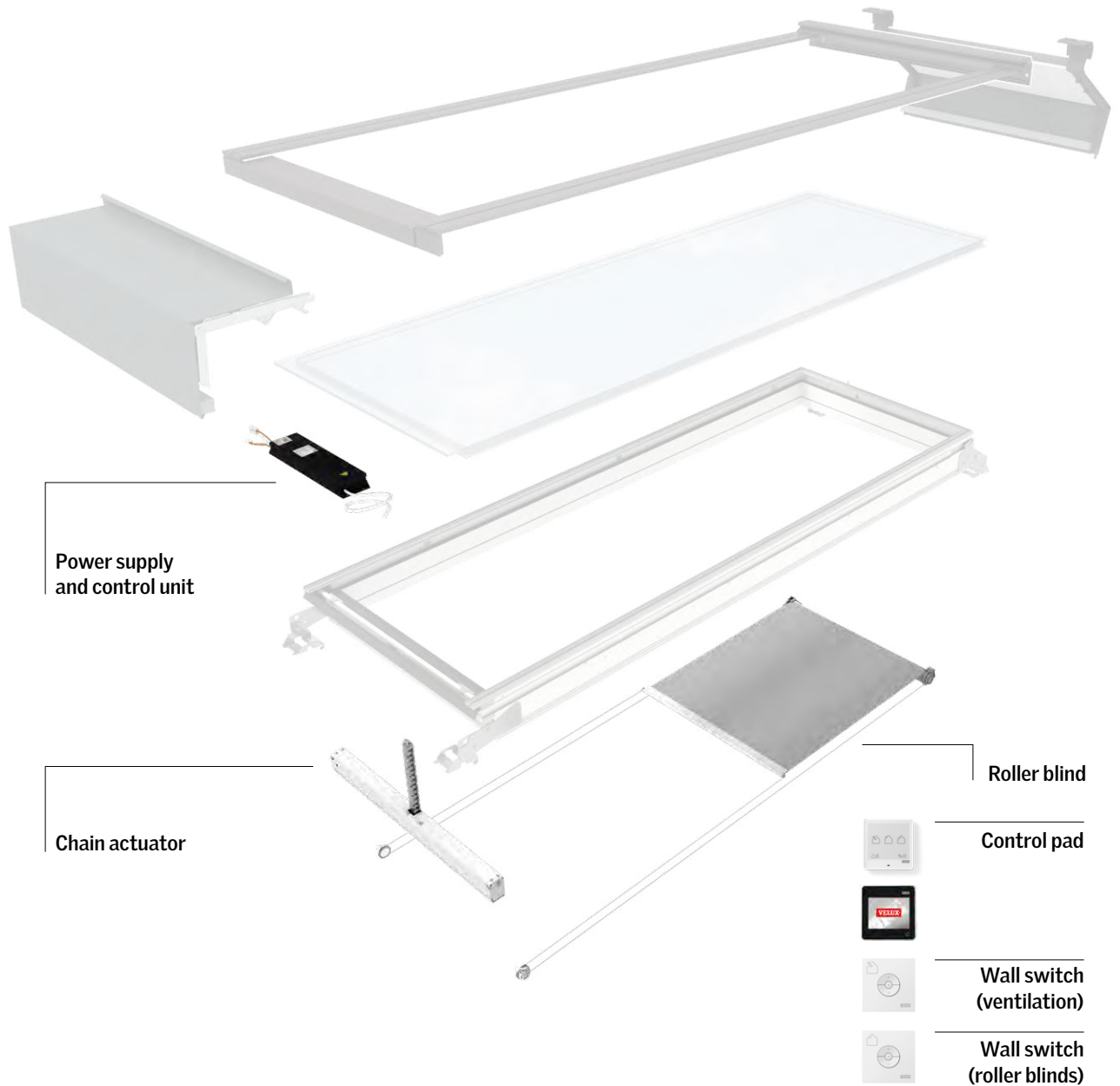

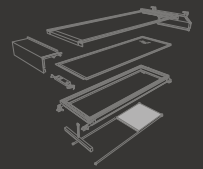

Electrical components

Control pad	Power supply and control unit	Rain sensor	Rain and wind sensor set
<p>KLR 200/KLR 300</p>	<p>KLC 410</p>	<p>KLA 200</p>	<p>KLA 105 KUX 110 KLF 200</p> <p>KLA S105</p>

Wall switch	Switch interface (external wall switch)	Interface (external control devices)
<p>KLI 311 (ventilation) KLI 312 (roller blinds)</p> <p>KLI 311/KLI 312</p>	<p>KLF 050</p>	<p>KLF 200</p>

Chain actuator	Roller blind
<p>(No code – delivered with HVC module)</p>	<p>RMM + colour code (see Technical Handbook)</p>

fid

homeec



VELUX io-homecontrol®

control®

Chain actuator VELUX io-homcontrol®



VELUX venting modular skylights are top-hung and use a hidden chain actuator integrated at the bottom profile. The VELUX chain actuator combined with control unit KLC 410 can

be operated with VELUX io-homcontrol® control pad KLR 200/KLR 300 or wall switch KLI 311 for user-friendly control.

VELUX io-homcontrol® – comfort ventilation	
Material	Anodised aluminium housing with zinc chromate passivated steel chain
Weight	Max 5.5 kg
Control system	VELUX io-homecontrol®
Supply cable*	1.2 m grey silicone cable, 3-core, 0.75 mm ² (white, brown, green**)
Chain stroke	260 mm
Opening speed	7 mm/s (full load)
Sound level	32 dB (min speed)***
Holding force (tractive)	5000 N (burglary strength) min
Pressure force	1000 Newton
Tractive force	300-1000 Newton
IP rating	IPX4
Operating conditions	-15°C - +76°C, max. 90% relative humidity (not condensing)
Nominal voltage	24 V DC (max 10% ripple)
Voltage	19-32 V DC
Max Voltage	32 V DC
Switch-on-duration	ED max 20% (2 minutes per 10 minutes)
Current consumption	Max. 2A
Service	It is recommended to carry out a function test of the actuator at least once a year and to make sure that the skylight opens correctly
CE marking	The product is tested with VELUX control unit KLC 410 and complies with the EMC directive's requirements for use in residential, commercial and light commercial buildings.
Reservation	The VELUX Group reserves the right to make technical changes.

* The supply cable can be extended up to 20 m with a 3-core cable with a minimum cross-section of 1.5 mm².

** Green = Green cable has no function.

*** The sound level can vary depending on the building conditions.



Comfort venting VELUX Modular Skylights meet the requirements of the harmonised standard EN 60335-2-103(2015) as to a max opening clearance of 200 mm (by means of physical limitation of the actuator) and as to the max closing speed of 15 mm/sec. Therefore, comfort venting skylights can be installed within reach, i.e. at installation heights below 2.5 m above floor level (inside) and ground level (outside). According to EN 60335-2-103 access levels are defined as e.g. stairs and terraces. Surfaces not normally used for standing on, such as windowsills, and movable equipment such as ladders, are not considered to be access level.

Please note that the venting skylights operate with high closing force, which can cause serious injury in case of entrapment. If VELUX roller blinds are installed in the skylight, please observe recommendations in the safety instructions provided with each VELUX roller blind RMM.

We recommend that you observe national regulations and consider if the planned specific use of the building requires additional safety measures that must be applied by the installer/user to prevent serious injury.

Smoke venting VELUX Modular Skylights and comfort venting VELUX Modular Skylights with a longer chain stroke than standard have a recommended minimum installation height of 2.5 m above floor level (inside) and ground level (outside). If they are installed below this level, safety measures must be applied by the installer/user to prevent serious injury. No instruction or measure can eliminate the inherent hazards resulting from installation heights below 2.5 m.

The VELUX Group will not accept responsibility for damages, injury or death resulting from such an installation. The installer/user is ultimately responsible for own omissions and actions. Measures could for instance be to install a motion sensor that is able to disconnect power from the control unit in case of any movement in the immediate vicinity of the VELUX Modular Skylights.

Power supply and control unit – KLC 410



Venting modular skylights and roller blinds controlled with VELUX io-homecontrol® products will be powered and controlled by control unit KLC 410.

Each KLC 410 can operate one venting skylight module and up to four roller blinds individually, in groups or simultaneously.

Power supply and control unit – KLC 410	
Material and colour	Black fire resistant polycarbonate
Size and weight	Product including packaging: 587 mm x 80 mm x 166 mm (W x H x D) 2.0 kg Control unit: 380 mm x 36 mm x 87 mm (W x H x D) 1.5 kg
Installation	24 V DC SELV class III construction output. The control unit is for use in small/medium installations with VELUX Modular Skylights. The control unit is installed under the front flashing of VELUX Modular Skylights and functions at temperatures between -15°C and +50°C. ta = 40°C The control unit is equipped with a 2.2 m 2-core cable (2 x 1.5 mm ² H05VV-F) and plug for connection to the mains supply. Radio frequency range: 300 m range open field. Depending on the building construction, the indoor range is approximately 30 m.
IP rating	IPX4
Power supply characteristics	Primary side: 230/240 V AC – 50 Hz / 250 W Secondary side: 24 V DC – 10 A class III construction output.
Connection	The control unit can supply power to one venting skylight module and/or up to four roller blinds RMM. The connection wires are pre-fitted with wire-to-wire connectors. The connection wire to the chain actuator and roller blinds can be extended up to 20 m. See product guide for more information.
Compatibility	KLC 410 is based on radio frequency (RF) technology and signals are transmitted in the 868 MHz range. Can be used with VELUX Modular Skylights chain actuator and roller blinds RMM. VELUX electrical products connected to KLC 410 can be operated by io-homecontrol® compatible activation controls and potential free input.
CE marking	CE-marked to indicate that it is in accordance with the following EU directives: CPR, LVD, MD, RoHS, WEEE, R&TTE, Packaging waste directive and EMC for household, trade and light industry. Combinations of VELUX electrical products meet the requirements of above-mentioned directives.
Note	The VELUX Group reserves the right to make technical changes.

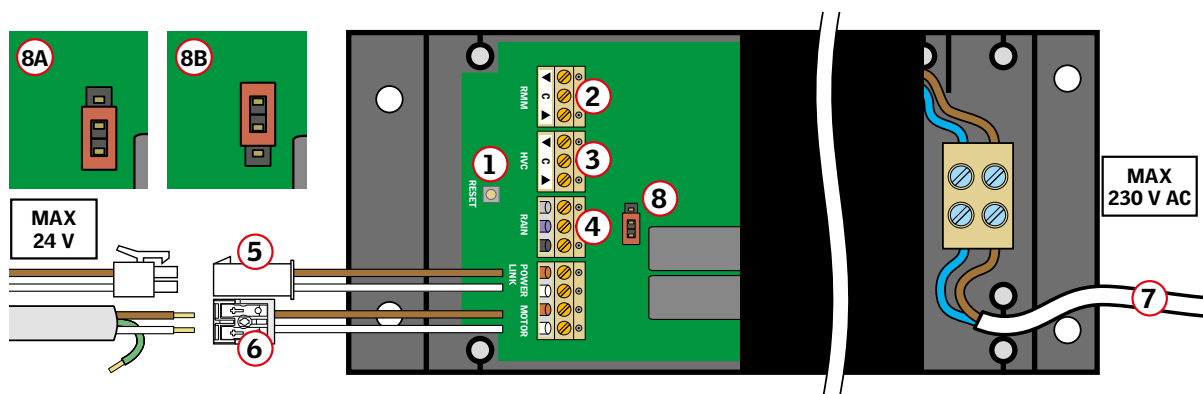

- ① RESET-button for registration of control or potential-free switch. After a long press (6-10 sec) registration in remote control must take place within 10 min.
- ② Potential-free entry for roller blinds
- ③ Potential-free entry for chain actuator
- ④ Entry for rain sensor KLA 200
- ⑤ Plug connector for roller blinds
- ⑥ Plug connector for chain actuator
- ⑦ 230 V AC, consumption max 250 W
- ⑧ Jumper for compulsory chain actuator detection

Control pad – KLR 200



Application

Control pad KLR 200 can be used for operation of io-homecontrol® compatible electrical products such as VELUX actuators and electrically operated roller blinds. The control pad allows the skylight modules and roller blinds to be set in any position. The control pad can be used for operation of several different VELUX products.

The control pad package consists of:

- Control pad with magnetic holder
- 3 x alkaline AA batteries

Function

With the control pad all products can be operated by tapping icons/ buttons or by dragging the slider and tapping the bar in the display. The control pad is based on wireless RF technology, which offers easy application with both new and existing installations with io-homecontrol® compatible products. An integrated security code ensures that operation can take place via authorised activation controls only.

Installation

The control pad can be wall-mounted with or without the supplied magnetic holder. As the control pad is battery driven, wiring is not necessary, which makes the installation very easy. The instructions enclosed with the product provide further information on installation and use.

KLR 200	
Material and colour	ABS, white (NCS S 1000-N), black (RAL 9005) and metallic grey
Size and weight	Product including packaging: 235 x 153 x 48 mm (W x H x D), 250 g Control pad: 95 x 95 x 23 mm (W x H x D), 180 g
Use	For indoor use, maximum ambient temperature 50°C Radio frequency range: 200 m range open field. Depending on the building construction, the indoor range is approximately 20 m. Maximum number of products is 200*
Battery requirement	3 x alkaline AA (1.5 V) batteries Expected battery lifetime: Approximately 1 year
Compatibility	Based on radio frequency (RF) technology, transmitted in 868 MHz range. Compatible with products with the io-homecontrol® logo.
CE marking	CE-marked to indicate that it is in accordance with the following EU directives: CPR, LVD, MD, RoHS, WEEE, R&TTE, Packaging waste directive and EMC for household, trade and light industry. Combinations of VELUX electrical products meet the requirements of above-mentioned directives.
Note	This product has been designed for use with genuine VELUX products. Connection to other products may cause damage or malfunction. The VELUX Group reserves the right to make technical changes.

* Maximum recommended number of products is 100 and for daily use it is 50.

Control pad - KLR 300



Application

Control pad KLR 300 can be used for operation of io-homecontrol® compatible electrical products such as VELUX actuators and electrically operated roller blinds. The control pad allows the skylight modules and roller blinds to be set in predefined positions. The control pad can be used for operation of several different VELUX products.

The control pad package consists of:

- Control pad with magnetic holder
- 2 x alkaline AAA batteries

Function

With the control pad all products can be operated by tapping icons/ buttons or by dragging the slider and tapping the bar in the display. The control pad is based on wireless RF technology, which offers easy application with both new and existing installations with io-homecontrol® compatible products. An integrated security code ensures that operation can take place via authorised activation controls only.

Installation

The control pad can be wall-mounted with or without the supplied magnetic holder. As the control pad is battery driven, wiring is not necessary, which makes the installation very easy. The instructions enclosed with the product provide further information on installation and use.

KLR 300	
Material and colour	ABS, white (NCS S 1000-N)
Size and weight	Product including packaging: 92 x 99 x 74 mm (W x H x D), 331 g Control pad: 81 x 81 x 17 mm (W x H x D), 112g
Use	For indoor use, maximum ambient temperature 50°C Radio frequency range: 100 m range open field. Depending on the building construction, the indoor range is approximately 10 m Maximum number of products is 200*
Battery requirement	2 x alkaline AAA (1.5 V) batteries Expected battery lifetime: Approximately 1 year
Compatibility	Based on radio frequency (RF) technology, transmitted in 868 MHz range. Compatible with products with the io-homecontrol® logo.
CE marking	CE-marked to indicate that it is in accordance with the following EU directives: CPR, LVD, MD, RoHS, WEEE, R&TTE, Packaging waste directive and EMC for household, trade and light industry. Combinations of VELUX electrical products meet the requirements of above-mentioned directives.
Note	This product has been designed for use with genuine VELUX products. Connection to other products may cause damage or malfunction. The VELUX Group reserves the right to make technical changes.

* Maximum 99 of the same product type can be connected at once.

Wall switches – KLI 311/312



Application

Wall switches KLI 311 and KLI 312 can be used for simple operation of io-homecontrol® compatible electrical products such as VELUX Modular Skylights actuators and electrically operated roller blinds. KLI 311 can be used for opening/closing modules and KLI 312 can be used to operate roller blinds.

The wall switch consists of:

- Wall switch
- 2 x alkaline AAA batteries

The wall switch can be used for simultaneous operation of several products.

Function

The wall switch can make the electrical product travel to the maximum top or bottom position with one key pressure at the corre-

sponding button (up or down). Furthermore, the electrical product can be stopped at any desired position by pressing the button longer. The wall switch is based on wireless RF technology, which offers easy application with both new and existing installations with io-homecontrol® compatible products. An integrated security code ensures that operation can take place via authorised activation controls only. KLI 311/312 will operate all configured products simultaneously e.g. no time-lapse when running RMM.

Installation

The wall switch is wall-mounted and can easily be fitted by the end user. As the wall switch is battery driven, wiring is not necessary, which makes the installation very easy. The instructions enclosed with the product provide further information on installation and use.

KLI 311/312	
Material and colour	Wall switch: ABS (plastic), white (NCS S 1000-N)
Size and weight	Product including packaging: 235 mm x 153 mm x 48 mm (W x H x D) Weight: 0.224 kg. Wall switch: 80 mm x 80 mm x 17 mm (W x H x D) Weight: 0.1 kg.
Use and installation	The wall switch is for indoor use, maximum ambient temperature 50°C. Radio frequency range: 200 m range open field. Depending on the building construction, the indoor range is approximately 20 m. The wall switch must not be covered and it must not be installed in rooms with high levels of humidity, e.g. bathrooms. Can operate an unlimited number of products.
Battery requirement	2 x alkaline AAA (1.5 V) batteries. Expected battery lifetime: More than 2 years.
Compatibility	KLI 311/312 are based on radio frequency (RF) technology and signals are transmitted in the 868 MHz range. They are compatible with products with the io-homecontrol® logo and can be used with VELUX Modular Skylights and roller blinds.
CE marking	CE-marked to indicate that they are in accordance with the following EU directives: LVD, MD, RoHS, WEEE, R&TTE, Packaging waste directive and EMC for household, trade and light industry. Combinations of VELUX electrical products meet the requirements of above-mentioned directives.
Note	The VELUX Group reserves the right to make technical changes.

Switch interface – KLF 050 (external wall switch)

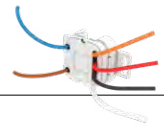

Application

Switch interface KLF 050 can be used for basic operation of io-homecontrol® compatible electrical products, such as VELUX Modular Skylights and roller blinds by means of a wide range of standard wall switches. This will enable the user to choose a wall switch design for operating the products that matches the other wall switches in the building.

Function

The switch interface can be used for individual operation of one product or simultaneous operation of several products. The products are activated via the switch interface in the following ways:

- Activating one entry briefly will make the product run either completely up or down
- Activating entries will stop the product
- Activating one entry for more than one second will make the product run up or down until the switch is released.

Different types of wall switches can be used for operating products:

- Single momentary switch: Used for opening, closing or stopping a product
- Double momentary switch: one part of the wall switch is used for opening or stopping a product, while the other part is used for closing or stopping a product. KLF 050 will operate all configured products which run simultaneously e.g. no time-lapse when running RMM.

Installation

The switch interface is designed to be installed behind various wall switches in a built-in wall socket. The dimensions of the switch interface (43 x 43 x 25 mm) should be taken into account when choosing the wall switch, as well as, the built-in wall socket. The interface comes complete with cables for connection of mains supply and cables for direct connection to the wall switch, making it easy and fast to install. Installation must be carried out by a certified electrician or a similarly qualified person in accordance with national regulations. The switch interface will not function a built-in wall socket made of metal.

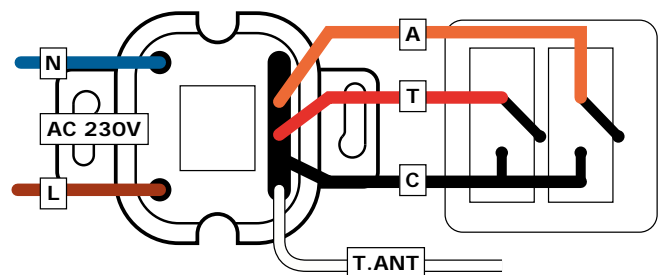
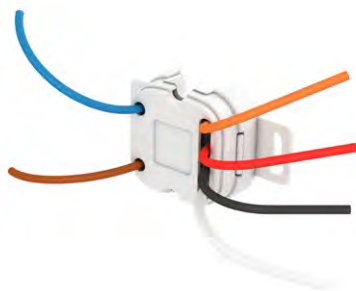

KLF 050	
Material and colour (visible parts)	PA6, white
Size and weight (including packaging)	Product in packaging: 213 x 116 x 96 mm, 0.117 kg. Switch interface: 43 x 43 x 25 mm (W x H x D), 0.025 kg.
Installation and use	Indoor installation at max 40°C. The switch interface is intended for concealed installation into permanent wall sockets. Radio frequency range: 300 m free field. Depending on building construction, the indoor range is approx. 30 m. However, constructions with reinforced concrete, metal ceilings and plaster walls with steel members may reduce the range.
Power consumption	1.2 W
Connection	230V AC mains supply. A current of 5-10 mA runs between the switch interface and the switches. The switches are not galvanically separated from the primary circuit. Function of switch interface entries: OPEN/UP/ON is controlled by connecting C and ▲ CLOSE/DOWN/OFF is controlled by connecting C and ▼ STOP is controlled by connecting C with both ▲ and ▼
Compatibility	Compatible with products with the io-homecontrol® logo. KLF 050 is based on one-way radio frequency (RF) technology and signals are transmitted in the 868 MHz range.
CE marking	This product has been CE-marked to indicate that it is in accordance with relevant EU directives LVD, MD, R&TTE and EMC for household, trade and light industry.
Note	This product has been designed for use with genuine VELUX products, and other io-homecontrol® compatible products. The VELUX Group reserves the right to make technical changes.

Interface – KLF 200 (external control devices)



Application

Interface KLF 200 is used when io-homecontrol® labelled products are to be controlled by external control devices that are not io-homecontrol® compatible. Through the interface these devices can operate VELUX Modular Skylights and roller blinds. The interface consists of:

- Interface unit with potential free input and io-homecontrol® output
- 1.2 m cable with mains plug.

Function

Interface KLF 200 is designed for control of 1-5 groups. Each group can handle several products of similar type. However, the individual groups may consist of any product type. Each group has a terminal for connection of the switch for opening and another terminal for connection of the switch for closing. As a default the interface will control the products in the group to fully open and fully closed positions.

The interface can operate up to 200 electrical products. The maximum number of products to be controlled in a single group is 200. The same product can be part of several groups if needed for local and whole-house control. 5 output terminals are available to provide a signal, for successful operation of an event triggered by the respective input terminal. A successful activation will make the potential free switch in the output terminal close for 2 seconds.

Using the optional web-based setup tool, more flexibility towards customisation is made available. A powerful, yet easy to use setup guide allows customisation of positions, priorities, output functionality a.o. details. Using the web-tool, full flexibility is given to the installer to define scenarios that can be triggered by each input terminal. A scenario is a snapshot of the products' position in the house at a given point in time. It could be e.g. the product's positions required when the alarm system in your house is activated. Normally this would close the windows fully and roll down roller shutters and awnings blinds. This scenario could be triggered simply by a relay output from the alarm system that indicates "alarm system ON". Both terminals in each of the 5 inputs can be set up to trigger a scenario, giving a total of up to 10 scenarios in the interface.

Installation

The external control devices, which must have potential free switches, are connected to the potential free input in the interface. The interface is designed for wall-mounted use. The soft LED indicator on the front surface indicates power ON and function status, and should be taken into account when placing the interface. The instruction leaflet enclosed with the product provides further information on setup and use.

KLF 200	
Material and colour	ABS, white (NCS S 1000-N)
Size and weight	Interface dimensions: 136 x 129 x 34 mm (W x H x D), 164 g
Use	For indoor use, maximum ambient temperature 50 °C Radio frequency range: 300 m range open field. Depending on the building construction, the indoor range is approximately 30 m Language: 32 individual languages included in the web-based setup tool supported by detailed context related help-functions. Can be used as repeater to extend the range of (2-way) RF signals in larger installations, where signals fail to reach certain electrical products. Prepared for future software updates.
Input for control	Potential free switch, with a rating of min 10 mA and 5 V DC. Control of 5 groups of products Please refer to the instruction leaflet for further information. The Ethernet terminal is for diagnostics/service by specialists in service organisations.
Output for feedback	Potential free switch, with a rating of max. 50mA and 30 V DC. The interface has 5 outputs to provide a signal for success for each of the 5 inputs. The output is normally open, and will close a circuit for the duration of 2 seconds after a successful operation of the products in that group. Please refer to the instruction leaflet for further information.
Power supply	Mains plug PSU with USB type micro B output with 1.2 m cable. Power consumption: 2W
Compatibility	Based on radio frequency (RF) technology, transmitted in 868 MHz range Compatible with products with the io-homecontrol® logo.
CE marking	CE-marked to indicate that it is in accordance with the following EU directives: LVD, MD, RoHS, WEEE, R&TTE and EMC for household, trade and light industry.
Note	The VELUX Group reserves the right to make technical changes.

Rain sensor – KLA 200



Function

The rain sensor automatically closes the module in case of rain and prevents unintentional opening when it rains. It is however possible to open the modules to a small degree (approximately 100 mm) with control pad KLR 200.

Installation

- One rain sensor is needed for every control unit KLC 410 and is connected to it with a 3-core cable.
- The cable can be extended up to 30 m with a 3-core cable with a minimum cross-section of 0.5 mm².
- The rain sensor does not require any additional setup once it is connected to KLC 410.
- The rain sensor is fitted with double adhesive tape for easy mounting on the flashings next to the module.

Rain sensor – KLA 200	
Material and colour	Plastic (Polycarbonate) NCS S 7500-N Gold plated trigger plate
Size and weight	Product including packaging: 235 x 153 x 48 mm (W x H x D), 0.127 kg Rain sensor: 50 x 31 x 8 mm (W x H x D), 0.033 kg
Use	For outdoor use, triggered by rain Ohmic resistance measurement
Connection	750 mm 3-core cable Can be extended up to 30 m with a 3-core cable with a minimum cross-section of 0.5 mm ²
Compatibility	Compatible with KLC 410, KFX 210-214, KFC 210/220, VELUX smoke ventilation windows GGL/GGU or VELUX flat-roof smoke ventilation windows CSP.
Note	This product has been designed for use with genuine VELUX products. Connection to other products may cause damage or malfunction. The VELUX Group reserves the right to make technical changes.

Rain and wind sensor set – KLA S105

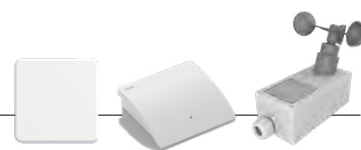

Contents of rain and wind sensor set KLA S105

- Rain and wind sensor KLA 105
- Power supply unit KUX 110
- Interface KLF 200

The rain and wind sensor consists of a rain sensor surface and a wind wheel. It is used for automatic control of comfort ventilation.

Function

The interface will send a wireless signal to close multiple modules, if the sensor is triggered by rain or strong wind.

Note: Depending on your settings, the rain sensor will be reset 10 or 20 minutes after the last sensor actuation.

Installation

The sensor is preferably installed 2 m above the roof surface, to avoid it being triggered by e.g. turbulence. The interface KLF 200 must be setup and have all modules registered by e.g. coping them from control pad KLR 200. In large buildings with several installations, up to three additional interfaces KLF 200 can be set up as repeaters to extend the operation range of the rain and wind sensor signal. See more recommendations on page 46-49.

Rain and wind sensor – KLA 105	
Material and colour	Housing in grey plastic, mounting bracket in aluminium
Voltage	19.6 V DC (from power supply unit KUX 110)
Circuit output	1 potential-free charge over contact
Contact rating	20 V / 1.8 A
Dimensions	80 x 160 x 55 mm (WxHxD, without wind wheel)
Weight	Approx 0.7 kg
IP rating	IP65
Setting of wind trigger threshold	Approx 3 to 14 m/s (±20%). Recommended: 8 m/s
Setting of wind or rain drop out delay	10 min/20 min. Recommended: 10 min
Setting of wind actuation delay	2 sec/5 sec. Recommended: 5 sec
Note	To be connected to power supply unit KUX 110 and interface KLF 200. 2-core connection cable not supplied.

Power supply unit – KUX 110	
Compatibility	The product is designed for use with genuine VELUX products and complies with the EMC directive's requirements for use in residential, commercial and light commercial buildings
Material and colour	Shockproof plastic, white (NCS S 1000-N)
Installation	Indoors in dry environment. The power supply must not be covered.
Input current	230 V AC
Output current	19.6 V DC 1.6A
Operating temperature	ta = 50°C
Connection	1.2 m 2-core cable with wall plug

Interface – KLF 200	
Material and colour	Shockproof plastic, white (NCS S 1000-N).
Size and weight	Interface dimensions: 136 x 129 x 34 mm (W x H x D), 164 g
Installation and use	For indoor use, maximum ambient temperature 50°C Radio frequency range: 300 m range open field. Depending on the building construction, the indoor range is approximately 30 m. The interface must not be covered.
Power consumption	230 V AC, 2W
Connection	Mains plug PSU with USB type micro B output with 1.2 m cable.
Compatibility	KLF 200 is based on radio frequency (RF) technology, 868 MHz range, and is compatible with other products with the io-homecontrol® logo.
CE marking	KLF 200 is CE-marked to indicate that it is in accordance with the EU directives LVD, MD, R&TTE and EMC for household, trade and light industry.
Note	The VELUX Group reserves the right to make technical changes.



Roller blind – RMM

VELUX io-homecontrol® and Open System		
Materials (visible parts)	Fabric	Polyester
	Wire	Stainless steel
	Control bar	Anodized aluminium
	Top pulley wheels	Stainless steel
Colours (cloth)	Grey, white and black (silver on the backside of the black)	
Weight	Max 3.4 kg	
Installation	Please see installation instructions	
Compatibility	All VELUX Modular Skylights with VELUX io-homecontrol® and ±24 V DC control systems	
Control system	VELUX io-homecontrol® or ±24 V DC	
Supply cable	0.2 m cable, 2-core, 0.75 mm ² (white, brown)	
RMM cable on skylight module**	0.35 - 1.35 m cable, 3-core, 0.75 mm ² (white, brown, green*)	
Running speed	70 mm/sec.	
IP rating	IPX0	
Sound level	< 70 dB	
Operating conditions	-5°C - +75°C, max. 90% relative humidity (not condensing)	
Nominal voltage	24 V DC (max 10% ripple)	
Voltage	19-24 V DC	
Switch-on-duration	ED max 20% (2 minutes per 10 minutes)	
Electric current requirement	Max 1A	
Service	It is recommended to carry out a function test of the roller blind at least once a year and to make sure that the roller blind runs correctly.	
CE marking	The product is tested with genuine VELUX control units and a ±24 V DC control system and complies with the EMC directive's requirements for use in residential, commercial and light commercial buildings.	
UL approval	VELUX roller blind RMM is approved in accordance with UL 325, Door, Drapery, Gate, Louver, and Window Operators and Systems.	
Reservation	The VELUX Group reserves the right to make technical changes.	

* Green cable has no function

** Only valid for pre-wired modules

Initialization

1. Connect the roller blind to control unit KLC 410
2. The RMM must be registered in a VELUX operation device within 10 min. of being connected to the power supply
3. The RMM is now ready for operation.

Calibration

The roller blind must be calibrated to the module, before it can be operated. The calibration will take place automatically the first time the roller blind is operated and again after 10 operations.

An automatic calibration also occurs with every 250 operations. Before the roller blind runs to the desired position, it runs all the way up and down. Do not interrupt the adjustment!

In rare occasions, the roller blind will have to be calibrated manually, if it e.g. does not stop at the right position at the top or bottom. To manually calibrate the roller blind:

- switch off the power for min. 10 sec.
- within 30 seconds after reconnection, press the STOP key and subsequently the UP/DOWN key on the operation device.



The blind cloth of VELUX roller blinds is pulled on two tension steel wires on pulley wheels, which are accessible, when the roller blinds are installed on skylights within reach and therefore can cause serious injury, if a person gets in contact with this during the electrical operation of the blind. VELUX roller blinds have a recommended minimum installation height of 2.5 m above floor level (inside) and ground level (outside). In case of installation below that level, safety measures must be applied by the installer/user to prevent serious injury. No instruction or measure can eliminate the inherent hazards resulting from installation heights below 2.5 m.

We recommend you to observe national regulations and consider if the planned specific use of the building requires that additional safety measures must be applied by the installer/user to prevent serious injury.

The VELUX Group will not accept responsibility for damages, injury or death resulting from such installation. The installer/user is ultimately responsible for own omissions and actions. Measures could for instance be to install a motion sensor that is able to disconnect power from the control unit in case of any movement in the immediate vicinity of the VELUX Modular Skylights.

VELUX io-homecontrol® electrical diagrams

Fixed modular skylights with sun screening

Description

This combination consists of four fixed modular skylights HFC with roller blinds RMM.

Possibilities and limitations





One control unit KLC 410 per four fixed modular skylights HFC with roller blinds RMM is required. Control unit KLC 410 can be positioned under the bottom flashing on a modular skylight or up to 20 m from it and is supplied with cables for connecting up to four roller blinds RMM in series.

Operation

Roller blinds RMM can be operated from either one of the following or a combination of:

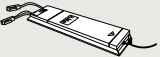
- control pad KLR 200/KLR 300 – individual or simultaneous operation
- wall switch KLI 312 – simultaneous operation
- switch interface KLF 050 – simultaneous operation.

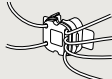
The operational range between a roller blind and the control unit is approximately 30 metres indoors. However, depending on the building construction and materials, the range can be longer. If needed, the range can be extended by using VELUX interface KLF 200 as a signal repeater station.

	Control unit	KLC 410	Requires 230 V AC supply	Power consumption max 250 W
	Control pad	KLR 200/KLR 300	Handheld or wall-mounted	Requires batteries
	Wall switch	KLI 312	Wall-mounted	Requires batteries
	Switch interface	KLF 050	Fitted into wall switch box supplied by others	Requires 230 V AC supply
	Interface	KLF 200	Requires 230 V AC supply	

Installations	Number of HFC with RMM per installation	Number of KLC 410
1	1-4	1
1	5-8	2
2	1-4	2

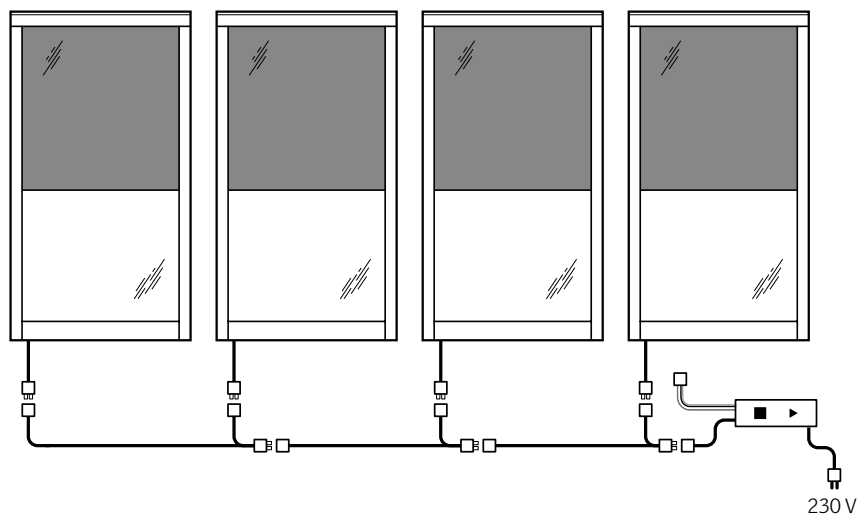

Fixed and venting modular skylights without sun screening

Description

Combination with fixed modular skylights HFC and venting modular skylights HVC but without VELUX sun screening products.

Possibilities and limitations

One control unit KLC 410 per one venting modular skylight HVC is required. Control unit KLC 410 can be positioned under the bottom flashing on a modular skylight or up to 20 m from it and is supplied with cables for connecting up to four roller blinds RMM in series.

Operation

Venting modular skylights HVC can be operated from either one of the following or a combination of:

- control pad KLR 200/KLR 300 – individual or simultaneous operation
- wall switch KLI 311 – simultaneous operation
- switch interface KLF 050 – simultaneous operation.

The operational range between the modular skylight and the control unit is approximately 30 metres indoors. However, depending on the building construction and materials, the range can be longer. If needed, the range can be extended by using VELUX interface KLF 200 as a signal repeater station.

Recommendation

It is recommended to install a rain sensor that will close the modular skylights in case of rain. This could be either KLA 200 or KLA S105. KLA 200 is a small rain sensor mounted on every venting module, see page 21. KLA S105 is a rain and wind sensor unit that will close multiple modular skylights in case of rain and strong wind. For more information, see page 22.

Note: Only one repeater is possible between interface and control unit.

	Control unit	KLC 410	Requires 230 V AC supply	Power consumption max 250 W
	Control pad	KLR 200/KLR 300	Hand held or wall-mounted	Requires batteries
	Wall switch	KLI 311	Wall-mounted	Requires batteries
	Switch interface	KLF 050	Fitted into wall switch box supplied by others	Requires 230 V AC supply
	Interface	KLF 200	Requires 230 V AC supply	
	Rain and wind sensor set	KLA S105	Requires 2 x 230 V AC supply	Contact rating max. 1.8 A
	Rain sensor	KLA 200	Requires KLC 410	

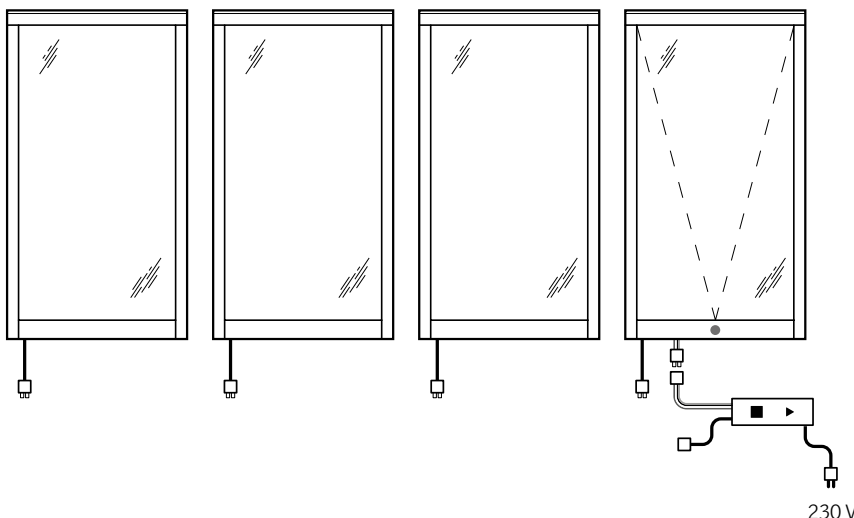
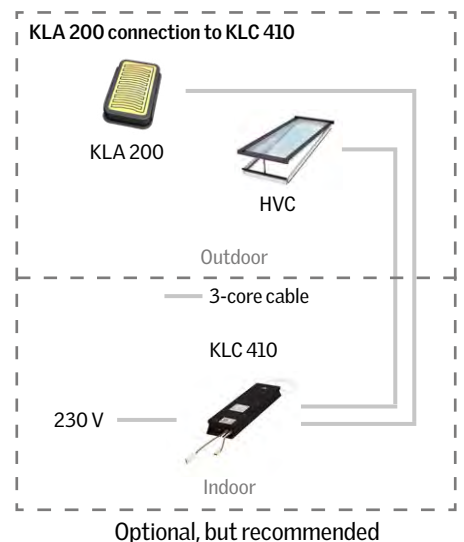
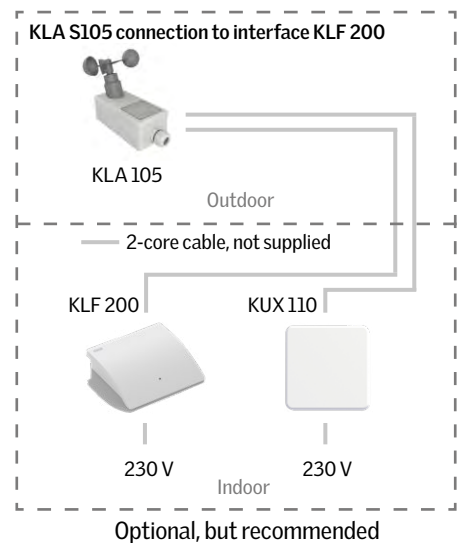

Fixed and venting modular skylights with sun screening

Description

Combination with fixed modular skylights HFC and venting modular skylights HVC with roller blinds RMM.

Possibilities and limitations

One control unit KLC 410 per one venting modular skylight HVC and three fixed modular skylights HFC with roller blinds RMM is required. Subsequently, one control unit KLC 410 per four fixed modular skylights HFC with roller blinds RMM is required.

Control unit KLC 410 can be positioned under the bottom flashing on a modular skylight or up to 20 m from it and is supplied with cables for connecting up to four roller blinds RMM in series and one venting modular skylight HVC within the same installation.

Operation

Venting modular skylights HVC-C and roller blinds RMM can be operated from either one of the following or a combination of:

- control pad KLR 200/KLR 300 – individual or simultaneous operation

- wall switch KLI 311 - simultaneous operation of modules
- wall switch KLI 312 - simultaneous operation of roller blinds
- switch interface KLF 050 – simultaneous operation.







The operational range between the modular skylight and the control unit is approximately 30 metres indoors. However, depending on the building construction and materials, the range can be longer.

If needed, the range can be extended by using VELUX interface KLF 200 as a signal repeater station.

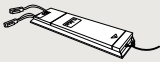
Recommendation

It is recommended to install a rain sensor that will close the modular skylights in case of rain. This could be either KLA 200 or KLA S105. KLA 200 is a small rain sensor mounted on every venting module, see page 21. KLA S105 is a rain and wind sensor unit that will close multiple modular skylights in case of rain and strong wind. For more information, see page 22.

Note: Only one repeater is possible between interface and control unit.

	Control unit	KLC 410	Requires 230 V AC supply	Power consumption max 250 W
	Control pad	KLR 200/KLR 300	Hand held or wall-mounted	Requires batteries
	Wall switch	KLI 311/KLI 312	Wall-mounted	Requires batteries
	Switch interface	KLF 050	Fitted into wall switch box supplied by others	Requires 230 V AC supply
	Interface	KLF 200	Requires 230 V AC supply	
	Rain and wind sensor set	KLA S105	Requires 2 x 230 V AC supply	Contact rating max. 1.8 A
	Rain sensor	KLA 200	Requires KLC 410	

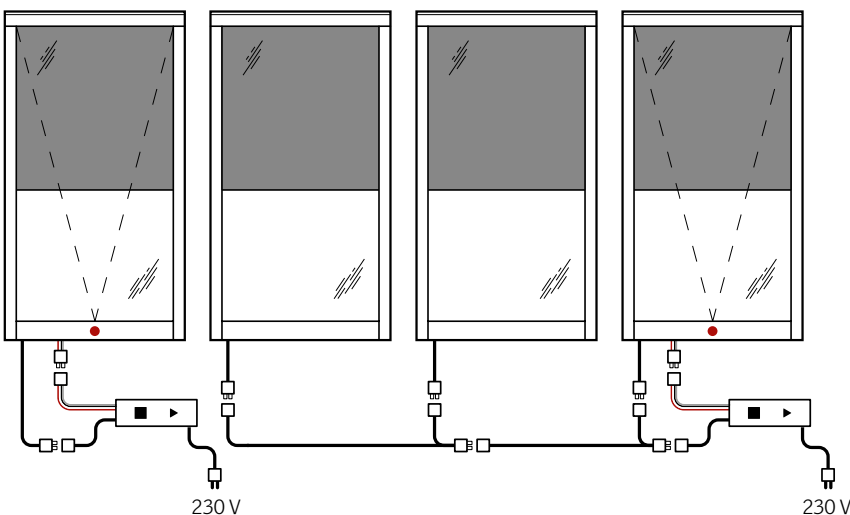
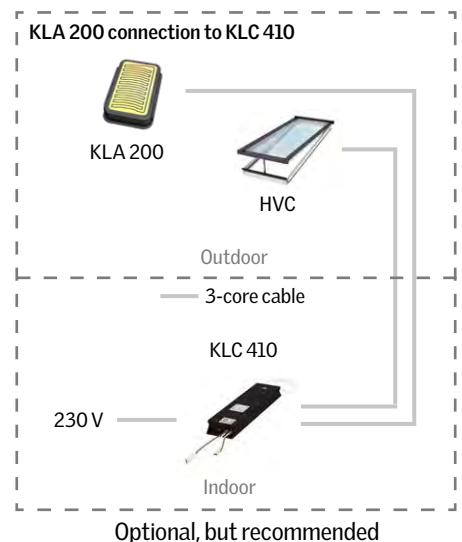
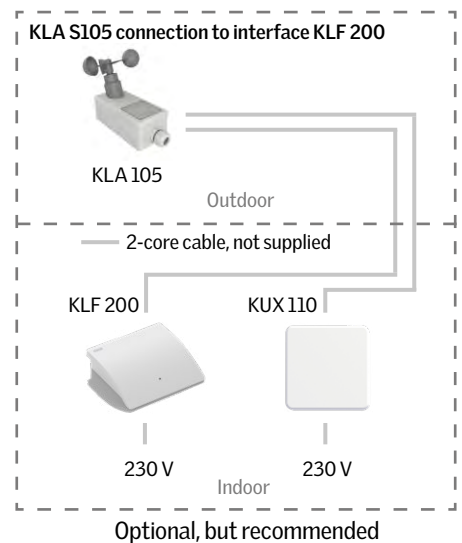



Open System

system

Comfort ventilation



Chain actuator

VELUX venting modular skylights are top-hung and use a hidden chain actuator integrated at the bottom profile. The chain actuator enables you to connect the installation to your preferred building management system.

Open system – comfort ventilation	
Material	Anodised aluminium housing with zinc chromate passivated steel chain
Weight	Max 5.5 kg
Control system	MotorLink™ or ±24 V DC
Supply cable*	1.2 m grey silicone cable, 3-core, 0.75 mm ² (white, brown, green**)
Chain stroke	260 mm
Opening speed	7 mm/s (full load)
Sound level	32 dB (min speed)***
Holding force (tractive)	5000 N (burglary strength) min
Pressure force	1000 Newton
Tractive force	300-1000 Newton
IP rating	IPX4
Operating conditions	-15°C - +76°C, max. 90% relative humidity (not condensing)
Nominal voltage	24 V DC (max 10% ripple)
Voltage	19-32 V DC
Max Voltage	32 V DC
Switch-on-duration	ED max 20% (2 minutes per 10 minutes)
Current consumption	Max. 2A
Service	It is recommended to carry out a function test of the actuator at least once a year and to make sure that the skylight opens correctly
CE marking	The product is tested with the original WindowMaster control units and complies with the EMC directive's requirements for use in residential, commercial and light commercial buildings
Reservation	The VELUX Group reserves the right to make technical changes.

*At standard ± 24 V DC connection maximum distances from venting skylight to power supply in accordance with calculation on next page

**Green = Communication wire for MotorLink™

*** The sound level can vary depending on the building conditions

Comfort ventilation

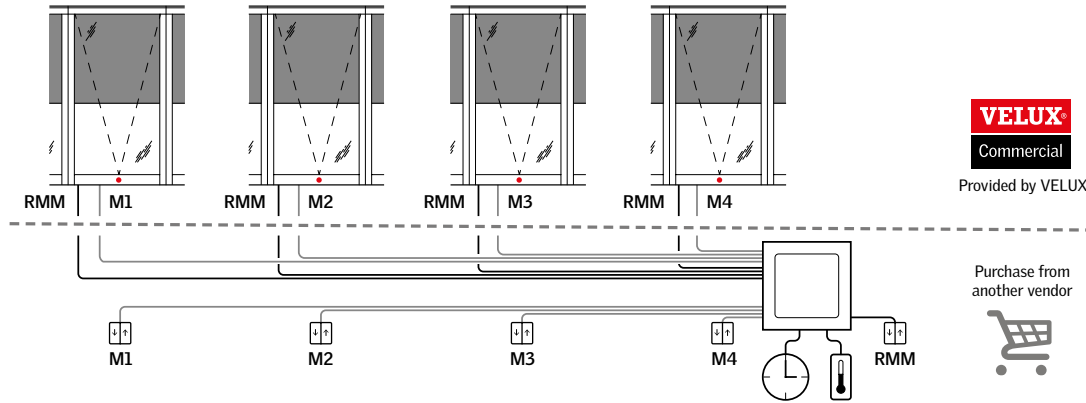

VELUX
Commercial

Provided by VELUX

Purchase from another vendor



Wiring length/dimension

$$\text{Max cable length} = \frac{(\text{admissible voltage drop (UL)} \times \text{conductivity of copper (56)} \times \text{cable cross-section (a)})}{(\text{total max. actuator current (I)} \text{ in amps} \times 2)}$$

Admissible voltage drop (UL) = 2 V

At MotorLink™ (3-core) connection maximum distances from roller blind to motor controller (power supply) is 50 m.

Max cable length when actuator is connected to power supply								
Cable cross-section (a)	3 x 0.75 mm ²	3 x 1.50 mm ²	3 x 2.50 mm ²	3 x 4.00 mm ²	3 x 6.00 mm ²	5 x 1.50 mm ² 2 cords in parallel	5 x 2.50 mm ² 2 cords in parallel	
Total actuator current (I)								
2A	21	42	70	112	168	84	140	metres
4A	11	21	35	56	84	42	70	metres
MotorLink™ power supply								
2A	21	42	50	50	50	50	50	metres
4A	11	21	35			42		metres

Connection of actuator

For correct connection to control system, see control system instructions.

		White	Green	Brown
±24V DC	Open	+	Maintenance cable – Do not connect	-
	Close	-		+
WindowMaster MotorLink™	Depending on system type	+	Motorlink™ communication	-

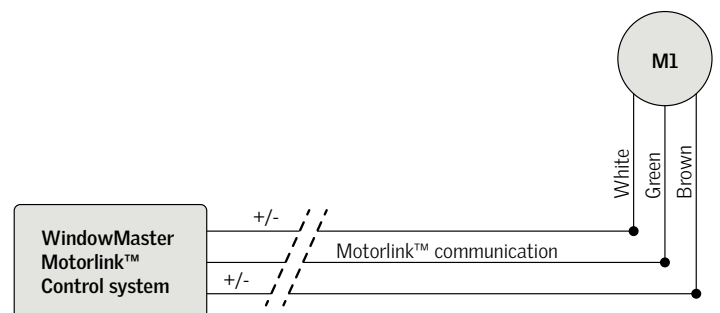
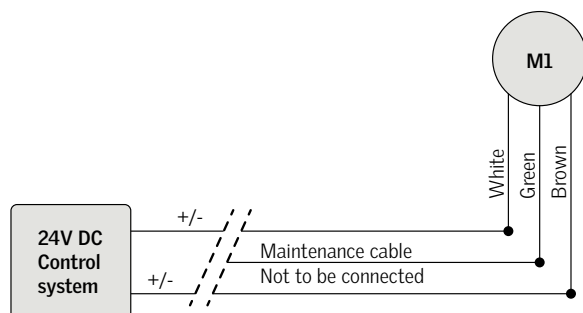

Comfort ventilation



Initialization

±24V DC

1. Connect the actuator's white and brown cords to a power supply.
2. Activate the chain actuator on the module one at a time by switching the white and brown cords between + and - (OPEN/CLOSE) until the actuator operates.
3. The actuator is now ready for operation.

MotorLink™

1. Connect all three cords on the actuator's cable to a MotorLink™ power supply with the power turned off.
2. Turn on the power supply.
3. Within 20 sec., the actuator will run in MotorLink™ mode.

Calibration

In rare occasions, the chain actuator will have to be calibrated. This is necessary when:

1. The window does not close completely:
If the actuator stops before the window is completely closed, open the window a couple of centimetres and close again. Repeat the procedure until the window is completely closed.
2. The window reverses approximately 5 cm:
Due to the built-in function that reduces the risk of entrapment, the actuator can sometimes open up to 5 cm while closing. If this happens, open the window a few centimetres (NEVER OPEN COMPLETELY) and then close it. It might be necessary to repeat the procedure 3-5 times until the window is closed (the right 0% point has been set).

Open the window completely and see that it opens 100%. The chain position 0% and 100% is now calibrated.

Important information

- All information in the HVC-C Declaration of Conformity applies!



Comfort venting VELUX Modular Skylights meet the requirements of the harmonised standard EN 60335-2-103(2015) as to a max opening clearance of 200 mm (by means of physical limitation of the actuator) and as to the max closing speed of 15 mm/sec. Therefore, comfort venting skylights can be installed within reach, i.e. at installation heights below 2.5 m above floor level (inside) and ground level (outside). According to EN 60335-2-103 access levels are defined as e.g. stairs and terraces. Surfaces not normally used for standing on, such as windowsills, and movable equipment such as ladders, are not considered to be access level.

Please note that the venting skylights operate with high closing force, which can cause serious injury in case of entrapment. If VELUX roller blinds are installed in the skylight, please observe recommendations in the safety instructions provided with each VELUX roller blind RMM.

We recommend that you observe national regulations and consider if the planned specific use of the building requires additional safety measures that must be applied by the installer/user to prevent serious injury.

Smoke venting VELUX Modular Skylights and comfort venting VELUX Modular Skylights with a longer chain stroke than standard have a recommended minimum installation height of 2.5 m above floor level (inside) and ground level (outside). If they are installed below this level, safety measures must be applied by the installer/user to prevent serious injury. No instruction or measure can eliminate the inherent hazards resulting from installation heights below 2.5 m.

The VELUX Group will not accept responsibility for damages, injury or death resulting from such an installation. The installer/user is ultimately responsible for own omissions and actions. Measures could for instance be to install a motion sensor that is able to disconnect power from the control unit in case of any movement in the immediate vicinity of the VELUX Modular Skylights.

Comfort ventilation electrical diagrams

Comfort ventilation and sun screening with $\pm 24V$ DC

Description

This example consists of venting modular skylights HVC-C with roller blinds RMM.

Possibilities

- Choice of control system protocol can be postponed till after purchase of VELUX Modular Skylights
- The modular skylights can be operated by a building management system through a control system
- Centrally located power supply and control
- The maximum operational range between the modular skylight and the control unit is approximately 100 metres depending on voltage drop
- Regrouping and definition of systems can be changed after installation.

Limitations

- Configuration can only be done by a certified technician (not VELUX).

Recommendations

It is recommended to use a rain and wind sensor that will close the modular skylights in case of rain and strong wind (recommended setting: 8 m/s).

Component description

Chain actuator

- The supply cable is a 1.2 metres 3-core silicone cable approved for hidden installation (white, brown, green)
- Chain stroke is 260 mm (programmable)
- Nominal voltage is 24 V DC (max. 10 % ripple)
- Current consumption max. 2A for comfort ventilation.

Roller blind

- The supply cable is a 0.2 metre 3-core cable (white, brown, green)
- Nominal voltage is 24 V DC (max. 10 % ripple)
- Current consumption max. 1A
- VELUX Modular Skylights can be ordered with pre-installed cables for roller blinds RMM.

Further information about the products can be found on veluxcommercial.com.

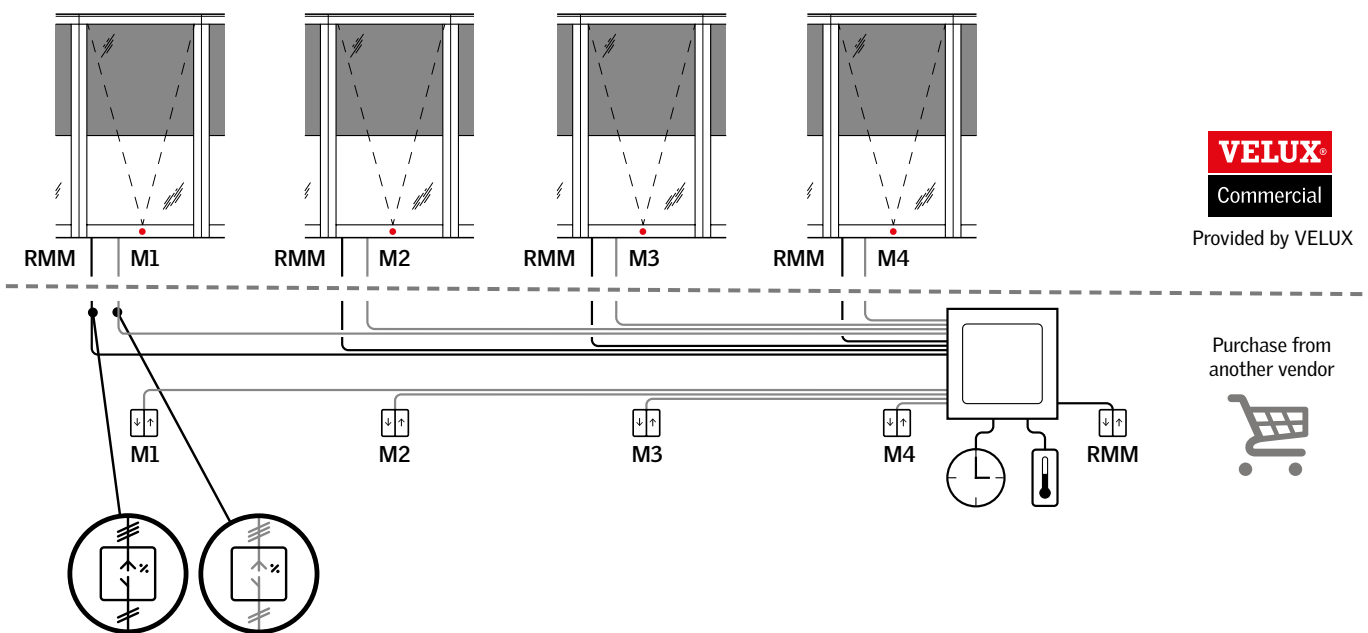

Provided by VELUX

Purchase from another vendor



M1-M4 = Actuator groups

Comfort ventilation and sun screening with advanced MotorLink™ control

Description

This example consists of venting modular skylights HVC-C for comfort ventilation with VELUX sun screening products, controlled by WindowMaster MotorLink™ control system.

Possibilities

- The modular skylights can be operated by a building management system through a WindowMaster MotorLink™ control system via KNX/LON/BacNet/Modbus
- Centrally located power supply and control
- The maximum operational range between the modular skylight and the control unit is 50 metres
- Regrouping and definition of systems can be changed after installation
- Stroke lengths can be changed after installation.

Limitations

- Configuration can only be done by a certified technician (not VELUX).

Recommendations

It is recommended to use a rain and wind sensor that will close the modular skylights in case of rain and strong wind (recommended setting: 8 m/s).

Component description

Chain actuator

- The supply cable is a 1.2 metres 3-core silicone cable approved for hidden installation (white, brown, green)
- Chain stroke is 260 mm (programmable)
- Nominal voltage is 24 V DC (max. 10 % ripple)
- Current consumption, nominal max. 2A for comfort ventilation.

Roller blind

- The supply cable is a 0.2 metres 3-core cable (white, brown, green)
- Nominal voltage is 24 V DC (max. 10 % ripple)
- Current consumption max. 1A
- Note! RMM does not support WindowMaster MotorLink™ functionality
- VELUX Modular Skylights can be ordered with pre-installed cables for roller blinds RMM.

Further information about the products can be found on veluxcommercial.com.

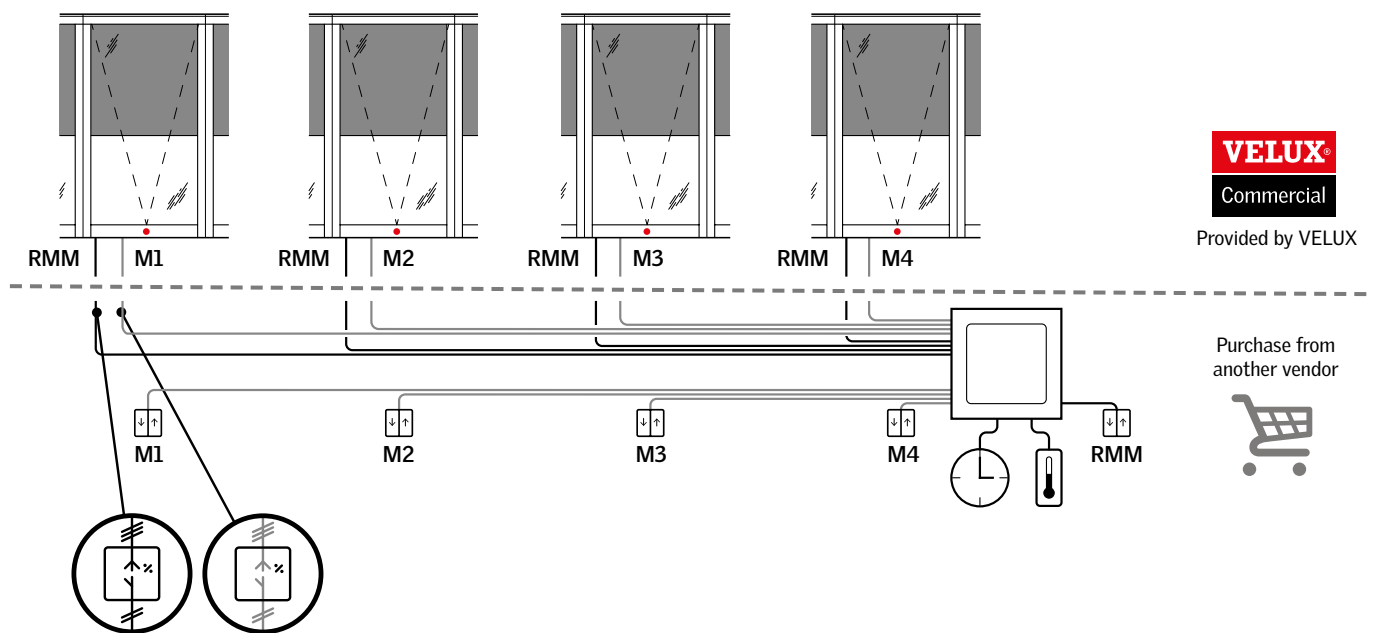

Provided by VELUX

Purchase from another vendor



M1-M4 = Actuator groups

Smoke ventilation



Chain actuator

VELUX venting modular skylights are top-hung and use a hidden chain actuator integrated at the bottom profile. Motorised smoke venting skylight module HVC-A allows smoke ventilation. The open system chain actuator enables you to connect the installation to your preferred building management system.

Open System – smoke ventilation	
Material	Anodised aluminium housing with zinc chromate passivated steel chain
Weight	Max 5.5 kg
Control system	MotorLink™ or ±24 V DC
Supply cable*	1.2 m grey silicone cable, 3-core, 0.75 mm ² (white, brown, green**)
Chain stroke	Up to 700 mm (depending on module size)
Opening speed	13 mm/s (full load)
Sound level	32 dB (min speed)***
Holding force (tractive)	5000 N (burglary strength) min
Pressure force	1300 Newton
Tractive force	300-1000 Newton
IP rating	IPX4
Operation conditions	-15°C - +76°C, max. 90% relative humidity (not condensing)
Nominal voltage	24 V DC (max 10% ripple)
Voltage	19-32 V DC
Max Voltage	32 V DC
Switch-on-duration	ED max 20% (2 minutes per 10 minutes)
Current consumption	2.5 - 5.5A depending on module size, glazing variant and required snow load****
Service	It is recommended to carry out a function test of the actuator at least once a year and to make sure that the skylight opens correctly.
CE marking	The product is tested with the original WindowMaster control units and complies with the EMC directive's requirements for use in residential, commercial and light commercial buildings.
Reservation	The VELUX Group reserves the right to make technical changes.

*At standard ± 24 V DC connection maximum distances from venting skylight to power supply in accordance to calculation:

$$\text{Max cable length} = \frac{(\text{admissible voltage drop (UL)} \times \text{conductivity of copper (56)} \times \text{cable cross-section (a)})}{(\text{total max. actuator current (I)} \text{ in amps} \times 2)}$$

Admissible voltage drop (UL) = 2 V

At MotorLink™ (3-core) connection maximum distances from roller blind to motor controller (power supply) is 50 m.

**Green = Communication wire for MotorLink™

*** The sound level can vary depending on the building conditions

**** For specific values, please see pages 82-85 of the Technical Handbook.

Max cable length when actuator is connected to power supply								
Cable cross-section (a)	3 x 0.75 mm ²	3 x 1.50 mm ²	3 x 2.50 mm ²	3 x 4.00 mm ²	3 x 6.00 mm ²	5 x 1.50 mm ² 2 cords in parallel	5 x 2.50 mm ² 2 cords in parallel	
Total actuator current (I)								
5.5A	7	15	25	40	61	30	50	metres
MotorLink™ power supply								
5.5A	7	15	25	40	50	30	50	metres

For connection of actuator, see page 31.

Preconditions for drive time for comfort ventilation with a smoke venting module
<p>When using a smoke ventilation skylight module HVC AB for comfort ventilation, it must be ensured that the comfort opening is in accordance with the tables on pages 96-97 of the Technical Handbook.</p> <p>The chain stroke for comfort opening function must be limited accordingly by the control system time to maintain lifetime expectancy and guarantee of the modules, and for example can be done by limiting the drive time in most simple control setup.</p> <p>The provided drive times to the right are examples valid for the default strongest motor variant N1300.</p> <p>When a lower power consumption motor variant is configured and used, the chain will travel at a lower speed depending on the size of the module. Therefore, in these situations the appropriate drivetime to reach the comfort opening must be established by the installer of the control system and set accordingly.</p> <p>The actuator is lifetime tested for comfort ventilation with a chain stroke up to 530 mm.</p>

Maximum drive time for comfort ventilation (HVC ---AB)		
Module height	Chain length [mm]	Drive time [sec]
800	260	20
1000	260	20
1200	260	20
1400	260	20
1600	260	20
1800	260	20
2000	260	20
2200	260	20
2400	260	20
2600	260	20
2800	260	20
3000	260	20



Read more in the Technical Handbook at: veluxcommercial.com



Comfort venting VELUX Modular Skylights meet the requirements of the harmonised standard EN 60335-2-103(2015) as to a max opening clearance of 200 mm (by means of physical limitation of the actuator) and as to the max closing speed of 15 mm/sec. Therefore, comfort venting skylights can be installed within reach, i.e. at installation heights below 2.5 m above floor level (inside) and ground level (outside). According to EN 60335-2-103 access levels are defined as e.g. stairs and terraces. Surfaces not normally used for standing on, such as windowsills, and movable equipment such as ladders, are not considered to be access level.

Please note that the venting skylights operate with high closing force, which can cause serious injury in case of entrapment. If VELUX roller blinds are installed in the skylight, please observe recommendations in the safety instructions provided with each VELUX roller blind RMM.

We recommend that you observe national regulations and consider if the planned specific use of the building requires additional safety measures that must be applied by the installer/user to prevent serious injury.

Smoke venting VELUX Modular Skylights and comfort venting VELUX Modular Skylights with a longer chain stroke than standard have a recommended minimum installation height of 2.5 m above floor level (inside) and ground level (outside). If they are installed below this level, safety measures must be applied by the installer/user to prevent serious injury. No instruction or measure can eliminate the inherent hazards resulting from installation heights below 2.5 m.

The VELUX Group will not accept responsibility for damages, injury or death resulting from such an installation. The installer/user is ultimately responsible for own omissions and actions. Measures could for instance be to install a motion sensor that is able to disconnect power from the control unit in case of any movement in the immediate vicinity of the VELUX Modular Skylights.

Smoke ventilation electrical diagrams

Smoke ventilation with ±24V DC

Description

This example consists of venting modular skylights HVC AB for smoke ventilation, without VELUX sun screening products.

Possibilities

- Choice of control system protocol can be postponed till after the purchase of VELUX Modular Skylights
- Centrally located power supply and control with backup power supply
- The maximum operational range between the modular skylight and the control unit is approximately 100 metres depending on voltage drop
- Regrouping and definition of systems can be changed after installation.

Limitations

- Configuration can only be done by a certified technician (not VELUX)
- Smoke venting modules with roller blinds RMM are not covered by VELUX approvals, therefore the local authorities should be consulted if roller blinds are required in connection with smoke ventilation.

Recommendations

It is recommended to use a rain and wind sensor that will close the modular skylights in case of rain and strong wind (recommended setting: 8 m/s).

Component description

Chain actuator

The supply cable is a 1.2 metres 3-core silicone cable approved for hidden installation (white, brown, green)

- Chain stroke is 353-700 mm depending on module size and application
- Nominal voltage is 24 V DC (max. 10 % ripple)
- Current consumption max. 5.5A.

Roller blind

- The smoke ventilators are tested and CE-marked in accordance with EN 12101-2. The tests were carried out without roller blinds by default.
- If a customer wishes to install roller blinds on the smoke ventilators subsequently, the VELUX Group recommends that the customer obtains written approval from the local fire authorities.
- VELUX Modular Skylights can be ordered with pre-installed cables for roller blinds RMM.

Further information about the products can be found on veluxcommercial.com.

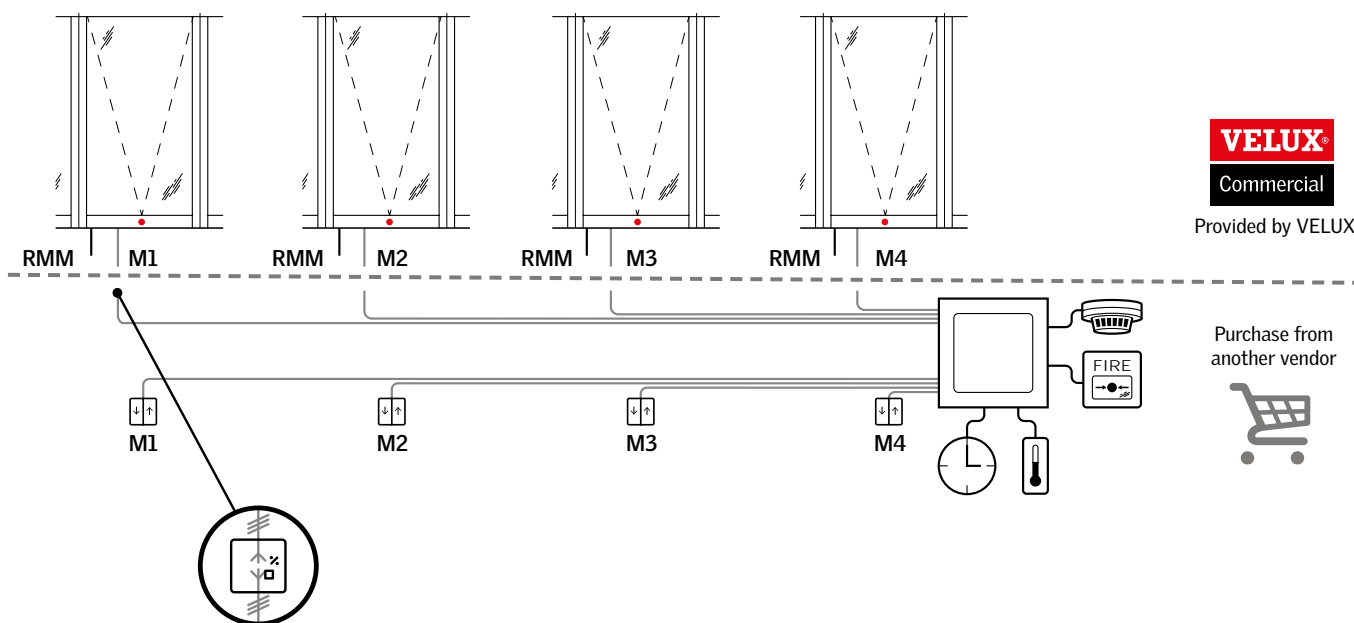

Provided by VELUX

Purchase from another vendor



M1-M4 = Actuator groups

Comfort and smoke ventilation with advanced MotorLink™ control

Description

This example consists of venting modular skylights HVC for smoke and comfort ventilation, without VELUX sun screening products, controlled by a WindowMaster MotorLink™ control system.

Possibilities

- Centrally located power supply and control with 72 hours backup power supply
- The modular skylights can be operated by a building management system through WindowMaster MotorLink™ control system via KNX/LON/BacNet/Modbus
- The maximum operational range between the modular skylight and the control unit is 50 metres
- Position control and speed parameters can be changed after installation
- Regrouping and definition of systems can be changed after installation
- There are different stroke lengths for comfort and smoke ventilation. The comfort stroke length must be set according to drive time table.

Limitations

- Configuration can only be done by a certified technician (not VELUX)
- Smoke venting modules with roller blinds are not covered by VELUX approvals, therefore the local authorities should be consulted if roller blinds are required in connection with smoke ventilation.

Recommendations

It is recommended to use a rain and wind sensor that will close the modular skylights in case of rain and strong wind (recommended setting: 8 m/s).

Component description

Chain actuator

- The supply cable is a 1.2 metres 3-core silicone cable approved for hidden installation (white, brown, green)
- Chain stroke is 353-700 mm depending on module size and application (programmable)
- Nominal voltage is 24 V C (max. 10 % ripple)
- Current consumption max. 5.5A.

Roller blind

- The smoke ventilators are tested and CE-marked in accordance with EN 12101-2:2003. The tests were carried out without roller blinds by default.
- If a customer wishes to install roller blinds on the smoke ventilators subsequently, the VELUX Group recommends that the customer obtains written approval from the local fire authorities.
- Note! RMM does not support WindowMaster MotorLink™ functionality.
- VELUX Modular Skylights can be ordered with pre-installed cables for roller blinds RMM.

Further information about the products can be found on veluxcommercial.com.

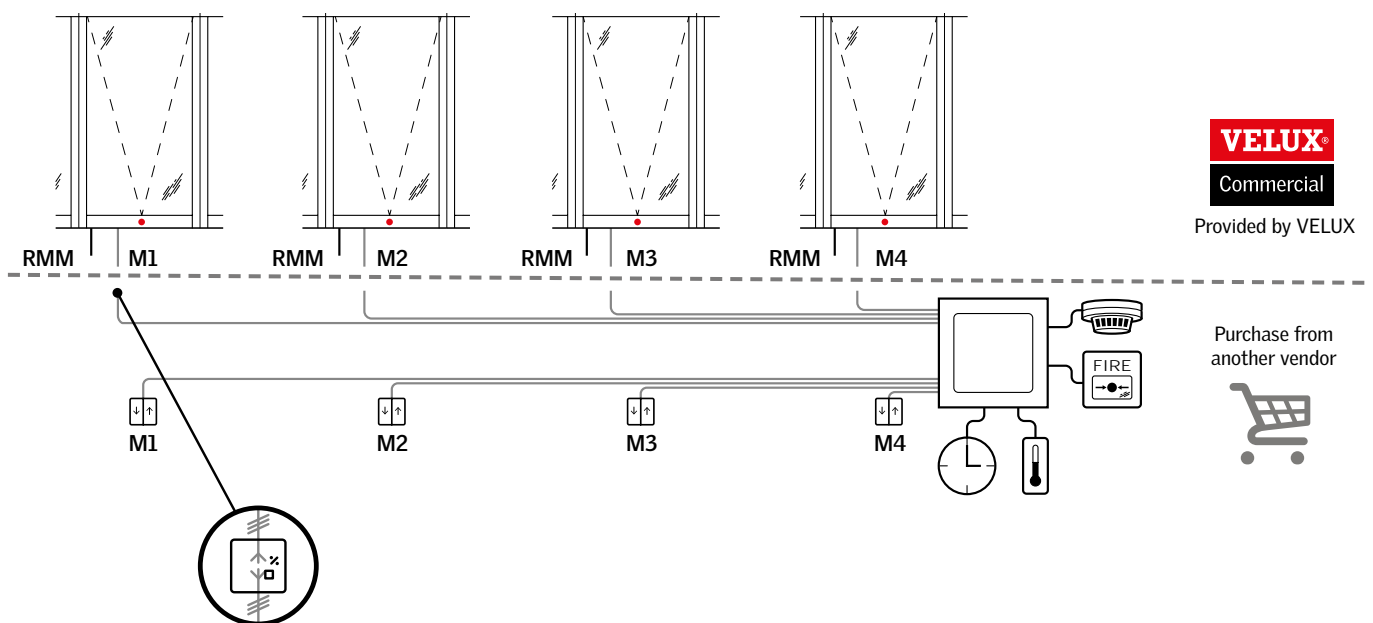

Provided by VELUX

Purchase from another vendor



M1-M4 = Actuator groups

Roller blind – RMM



VELUX io-homecontrol® and Open System		
Materials (visible parts)	Fabric	Polyester
	Wire	Stainless steel
	Bottom rail	Anodized aluminium
	Top pulley wheels	Stainless steel
Colours (cloth)	Grey, white and black (silver on the backside of the black)	
Weight	Max 3.4 kg	
Installation	Please see installation instructions	
Compatibility	All VELUX Modular Skylights with VELUX io-homecontrol® and ±24 V DC control systems	
Control system	VELUX io-homecontrol® or ±24 V DC	
Supply cable	0.2 m cable, 2-core, 0.75 mm ² (white, brown)	
RMM cable on skylight module*, ***	0.35 - 1.35 m cable, 3-core, 0.75 mm ² (white, brown, green**)	
Running speed	70 mm/sec.	
IP rating	IPX0	
Sound level	< 70 dB	
Operating conditions	-5°C - +75°C, max. 90% relative humidity (not condensing)	
Nominal voltage	24 V DC (max 10% ripple)	
Voltage	19-24 V DC	
Switch-on-duration	ED max 20% (2 minutes per 10 minutes)	
Power consumption	Max 1A	
Service	It is recommended to carry out a function test of the roller blind at least once a year and to make sure that the roller blind runs correctly.	
CE marking	The product is tested with genuine VELUX control units and a ±24 V DC control system and complies with the EMC directive's requirements for use in residential, commercial and light commercial buildings.	
UL approval	VELUX roller blind RMM is approved in accordance with UL 325, Door, Drapery, Gate, Louver, and Window Operators and Systems.	
Reservation	The VELUX Group reserves the right to make technical changes.	

* For Open system ± 24 V DC connection, the maximum distance from roller blind to power supply is in accordance with the following calculation:

$$\text{Max.cable length} = \frac{(\text{admissible voltage drop (UL)} \times \text{conductivity of copper (56)} \times \text{cable cross-section (a)})}{(\text{total max. actuator current (I) in amps} \times 2)}$$

Admissible voltage drop (UL) = 2 V

** Green cable has no function

*** Only valid for pre-wired modules

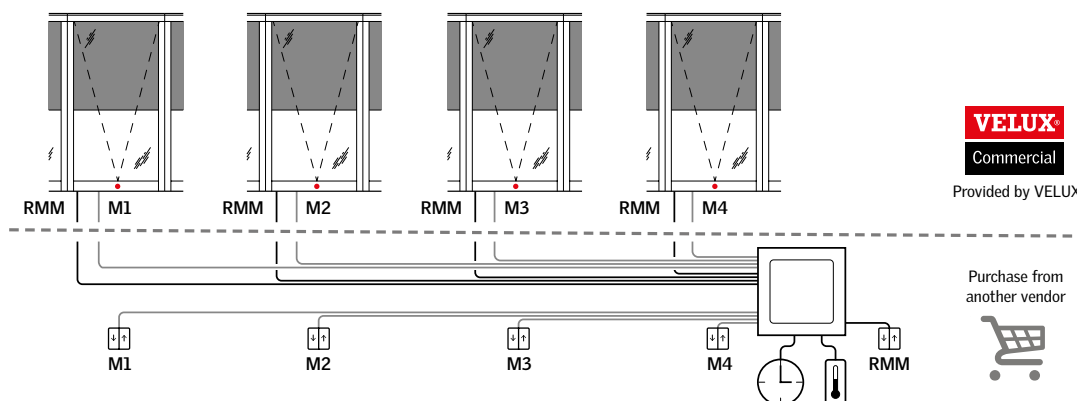

Provided by VELUX

Purchase from another vendor





Open System

Max cable length when actuator is connected to power supply								
Cable cross-section (a)	3 x 0.75 mm ²	3 x 1.50 mm ²	3 x 2.50 mm ²	3 x 4.00 mm ²	3 x 6.00 mm ²	5 x 1.50 mm ² 2 cords in parallel	5 x 2.50 mm ² 2 cords in parallel	
Total RMM current (I)								
1A	42	84	140	224	336	168	280	metres
2A	21	42	70	112	168	84	140	metres
3A	14	28	47	75	112	56	93	metres
4A	11	21	35	56	84	42	70	metres

Connection of roller blind (RMM)

For correct connection to control system, see control system instructions.

		White	Brown
±24V DC	UP	-	+
	DOWN	+	-

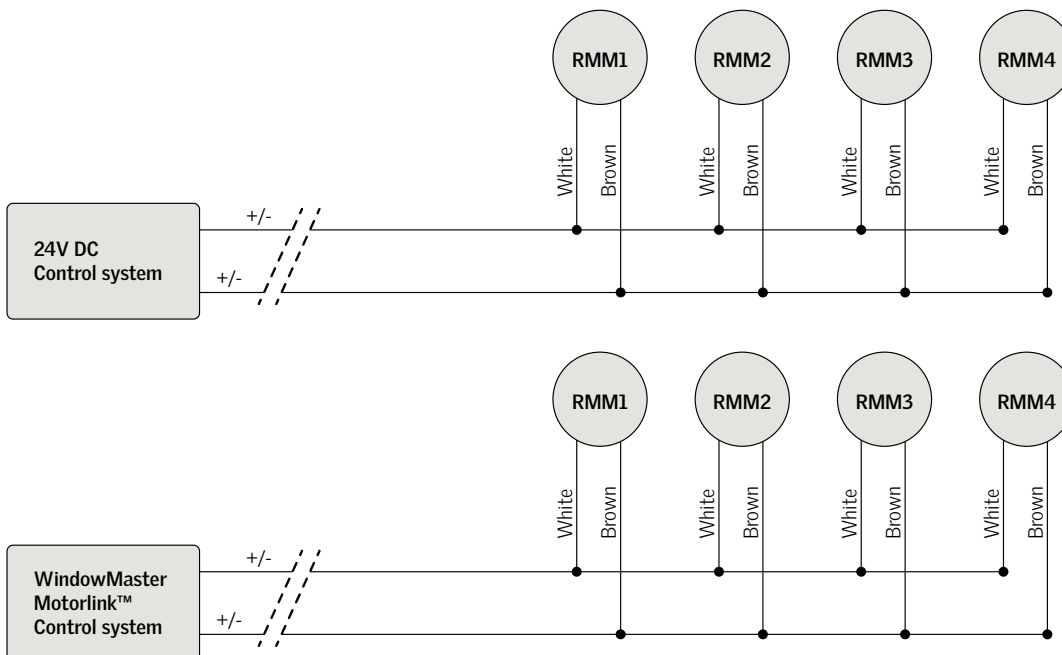

Open System



Initialization

±24V DC

1. Connect the white and brown cords on the modules' RMM cable to a power supply.
2. The RMM is now ready for operation.

Calibration

The motor must be adjusted to the size of the module before the roller blind can be operated. The adjustment will take place automatically the first time the roller blind is operated and again after 10 operations.

An automatic calibration also occurs with every 250 operations.

Before the roller blind runs to the desired position, it runs all the way up and down. Do not interrupt the adjustment!

In rare occasions, the RMM will have to be calibrated manually, if it e.g. does not stop at the right position at the top or bottom.

To manually calibrate the roller blind:

- ensure that the roller blind is in the top position
- press the UP function on your wall switch 5 times in a row, for at least one second at a time
- press DOWN on your wall switch.

Important information

- All information in the RMM Declaration of Conformity applies!
- The smoke ventilators are tested and CE-marked in accordance with EN 12101-2. The tests were carried out without roller blinds by default. If a customer wishes to install roller blinds on the smoke ventilators subsequently, the VELUX Group recommends that the customer obtains written approval from the local fire authorities.
- The fire resistant modules are tested in accordance with EN 1365-2. The classifications are expressed in accordance with EN 13501-2+A1. The tests are carried out without roller blinds by default. If a customer wishes to install roller blinds on the fire resistant modules subsequently, the VELUX Group recommends that the customer obtains written approval from the local fire authorities.



The blind cloth of VELUX roller blinds is pulled on two tension steel wires on pulley wheels, which are accessible, when the roller blinds are installed on skylights within reach and therefore can cause serious injury, if a person gets in contact with this during the electrical operation of the blind. VELUX roller blinds have a recommended minimum installation height of 2.5 m above floor level (inside) and ground level (outside). In case of installation below that level, safety measures must be applied by the installer/user to prevent serious injury. No instruction or measure can eliminate the inherent hazards resulting from installation heights below 2.5 m.

We recommend you to observe national regulations and consider if the planned specific use of the building requires that additional safety measures must be applied by the installer/user to prevent serious injury.

The VELUX Group will not accept responsibility for damages, injury or death resulting from such installation. The installer/user is ultimately responsible for own omissions and actions. Measures could for instance be to install a motion sensor that is able to disconnect power from the control unit in case of any movement in the immediate vicinity of the VELUX Modular Skylights.

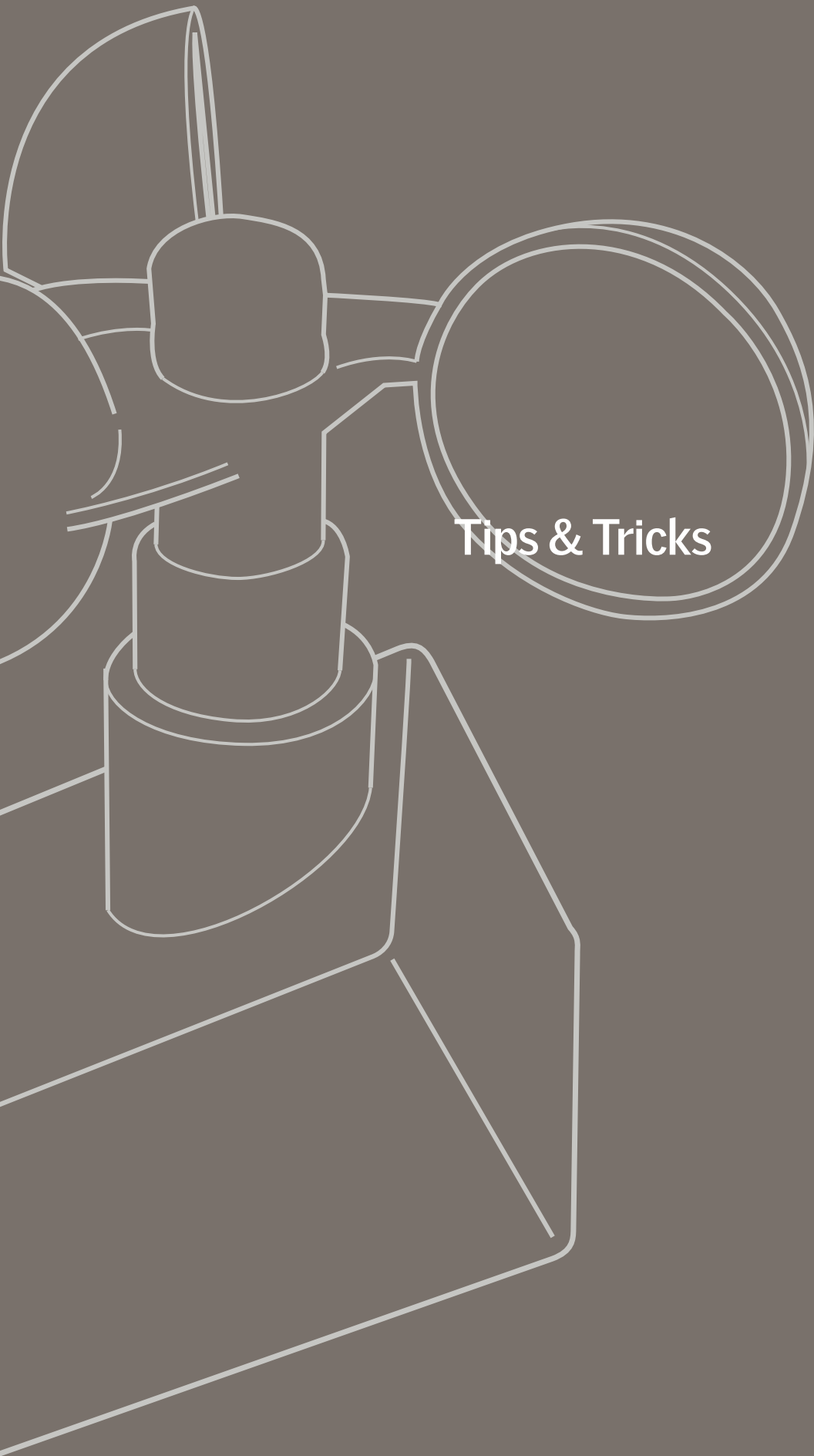

Tips & Tricks

Combining VELUX io-homecontrol® and Open System

It is possible to combine VELUX io-homecontrol® with the open system and have the following combinations:

Actuators in open system with comfort ventilation and roller blinds in VELUX io-homecontrol®:

Can be used if you have a building management system to control the modules to open and close and if you want the control of the roller blinds only to be local.

Actuators in open system with smoke ventilation and roller blinds in VELUX io-homecontrol® system:

Can be used if you have a fire control system to control the modules to open and close in case of fire and if you want the control of the roller blinds only to be local.

Note: Smoke ventilation with roller blinds RMM are not covered by VELUX approvals. Therefore, the local authorities should be consulted if roller blinds are required with smoke ventilation. The configuration can only be done by a certified technician (not VELUX).

If the above combinations are required please contact your Technical Market Support and they will provide the necessary electrical diagrams and documentation.

Recommended placement of rain and wind sensor

Best placement of KLA S105 is minimum 2 metres above roof level.

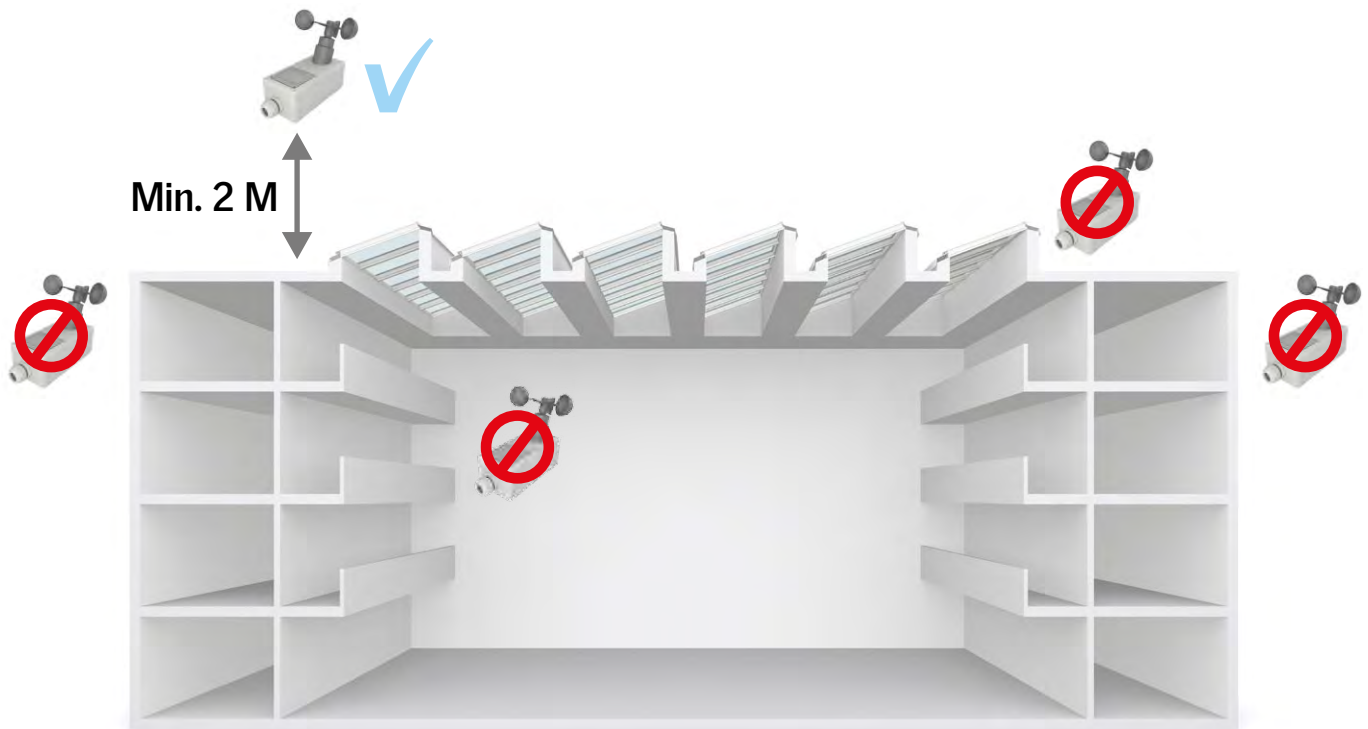

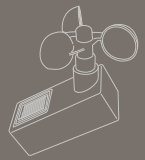

Wind deviation by building (side view)

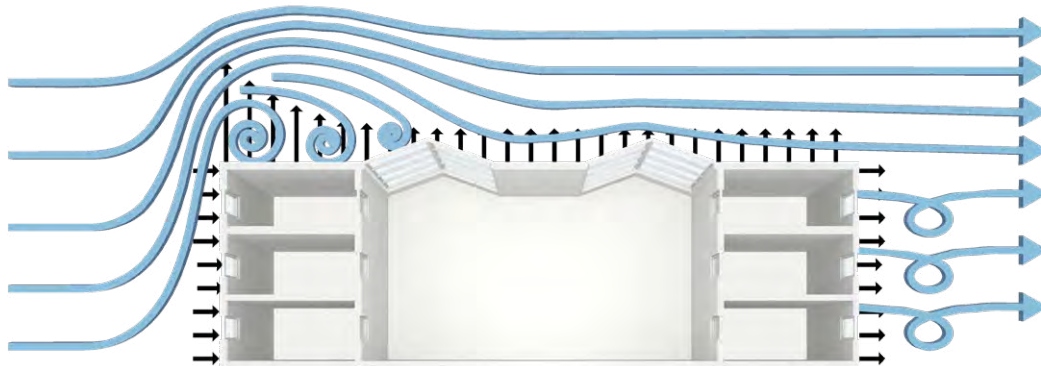

Source of images: DE 611XB549 Report, page 2, figure 1 and page 11

Recommended placement of interface KLF 200 as repeater in VELUX io-homecontrol®



Dos – Up to three repeaters can be connected to one interface.

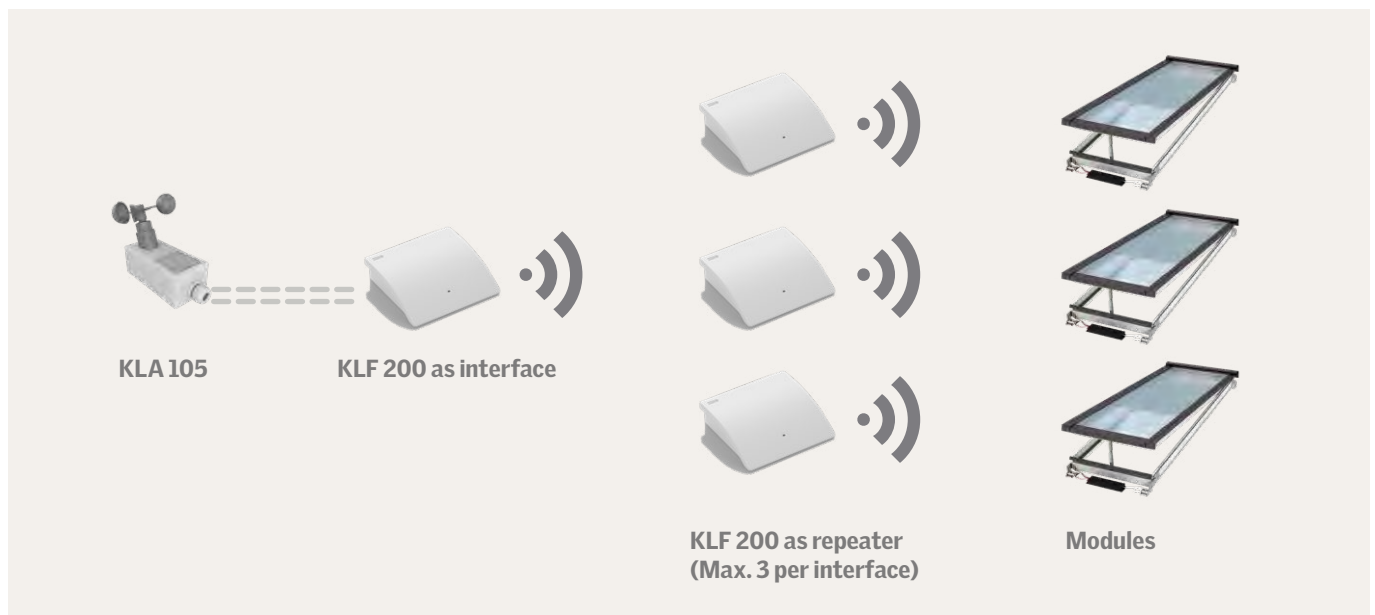

Don'ts – Signal can only be repeated one time in one direction.



Placement of interface KLF 200 in complicated building layout

- Longlights
- Roof
- Interface KLF 200
- Signal max. radius 30 m
- Interface KLF 200 (repeater)
- Signal max. radius 30 m

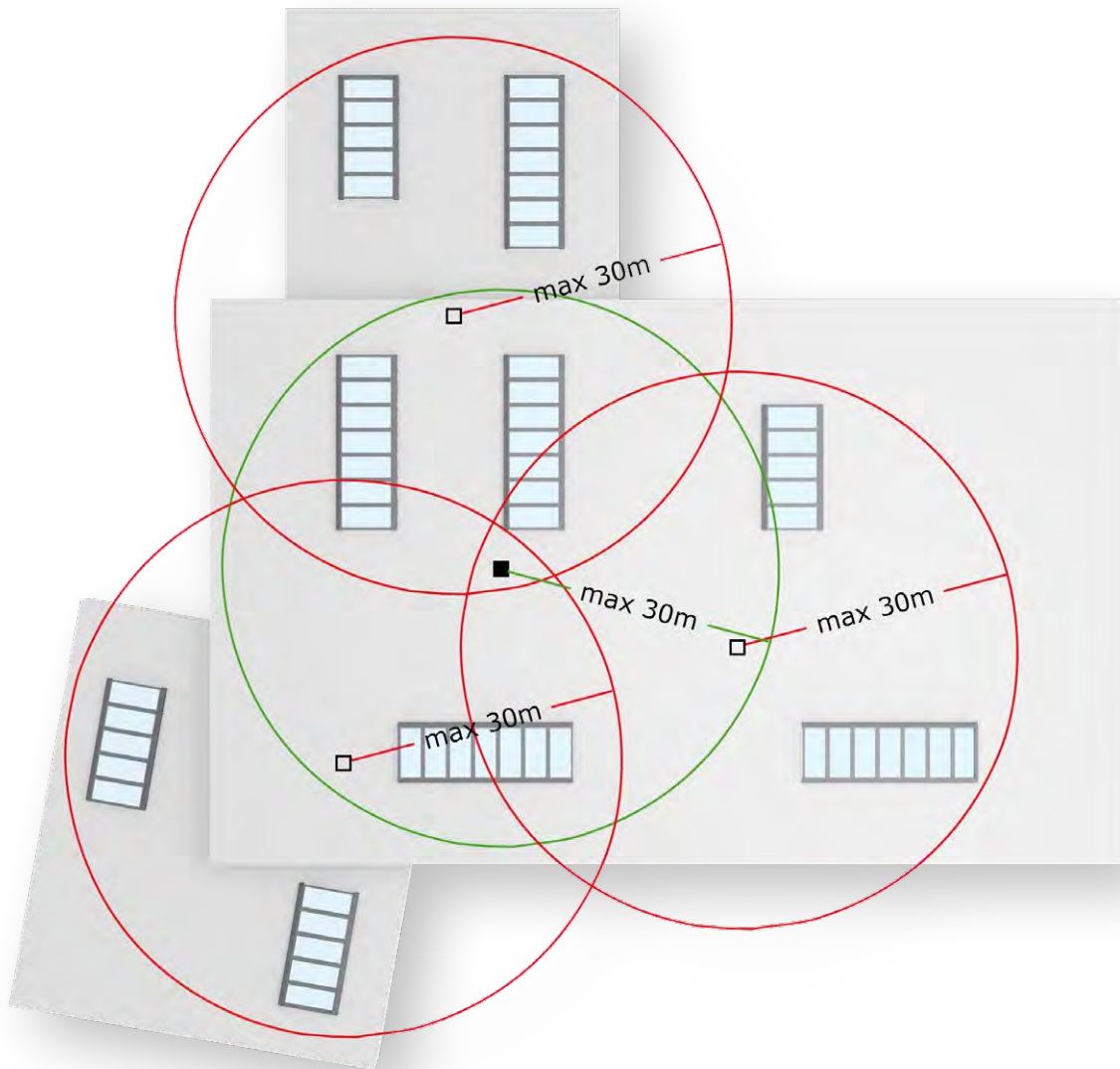

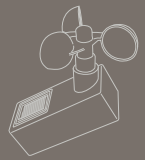

Reduction of IO signal

Some building materials will cause a reduction of the IO signal.
This should also be considered when planning the control system.

The rule of thumb is: 30 m in buildings

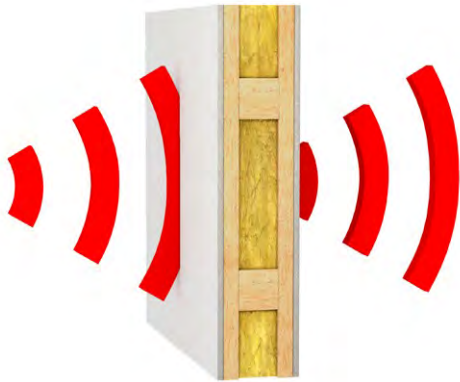

Wood, plaster walls.
Loss: 5 to 20%

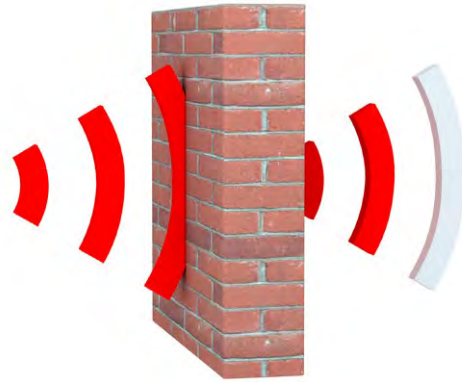

Brick, concrete.
Loss: 20 to 40%

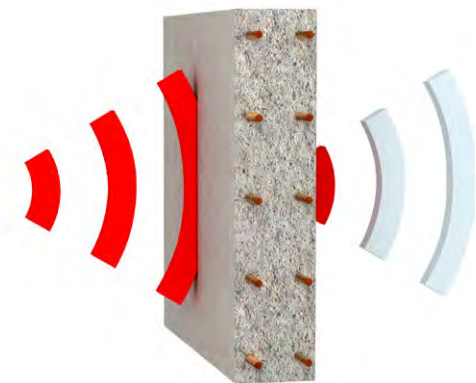

Reinforced concrete.
Loss: 40 to 90%



Enclosure in metal.
Loss: 90 to 100%

Your preferred partner for
daylight and ventilation solutions

VELUX®

Commercial

Version 4.3

17090-8-4 ELECTRICAL HANDBOOK BENELUX VERSION 4.3, JUNE 2023 © VELUX GROUP 2023. © VELUX AND THE VELUX LOGO ARE REGISTERED TRADEMARKS USED UNDER LICENSE BY THE VELUX GROUP. THE INFORMATION CONTAINED IN THIS HANDBOOK IS SUBJECT TO CHANGE WITHOUT NOTICE. PRINT ERRORS CAN OCCUR.