

VELUX electric roof window GGL

Glazing 70



The VELUX electric, centre-pivot roof window GGL is a wired solution that operates remotely using a wall switch – perfect for both in-reach and out-of-reach installations. The roof window has an integrated and silent motor. And if it rains, the rain sensor automatically closes the window.

- Rain sensor automatically closes the window in the event of rain.
- Electric-powered to allow for complete, seamless integration of your roof window into your home.
- The motor is hidden in the top cover and totally invisible from view.
- Easily control your roof window with the wireless wall switch that offers simple open/close/stop functionality.
- Compatible with VELUX ACTIVE with NETATMO for a better indoor climate with sensor-based ventilation. Remote controlled via smartphone or voice.
- Entrapment control detects objects in the path of the window.
- Silent motor keeps rooms quiet for sleeping children or simply for improved well-being.



Application guidance

The window can be installed in roof pitches between 15° and 90°.



VELUX electric and solar roof windows are easily operated by a wireless wall switch, providing fresh air at the touch of a button. Perfect for both within-reach and out-of-reach applications where extra comfort and convenient operation is required. For optimum view, choose longer roof windows for lower roof pitches.

Available sizes and daylight area

	472 mm	550 mm	660 mm	780 mm	942 mm	1140 mm	1340 mm
550 mm					GGL PK25 (0.027) [0.09]		
698 mm		GGL CK01 (0.19) [0.11]				GGL SK01 (0.48) [0.23]	
778 mm		GGL CK02 (0.22) [0.10]					
978 mm	GGL BK04 (0.23) [0.17]	GGL CK04 (0.29) [0.20]	GGL FK04 (0.38) [0.24]	GGL MK04 (0.47) [0.28]	GGL PK04 (0.60) [0.33]		GGL UK04 (0.91) [0.47]
1178 mm		GGL CK06 (0.37) [0.20]	GGL FK06 (0.47) [0.24]	GGL MK06 (0.59) [0.28]	GGL PK06 (0.75) [0.33]	GGL SK06 (0.95) [0.39]	
1398 mm			GGL FK08 (0.58) [0.24]	GGL MK08 (0.72) [0.28]	GGL PK08 (0.92) [0.33]	GGL SK08 (1.16) [0.39]	GGL UK08 (1.40) [0.46]
1600 mm				GGL MK10 (0.85) [0.28]	GGL PK10 (1.07) [0.34]	GGL SK10 (1.35) [0.40]	GGL UK10 (1.63) [0.46]

All measurements are in mm. () = Effective daylight area, m² [] = Geometric free area, m²

Cross section dimensions



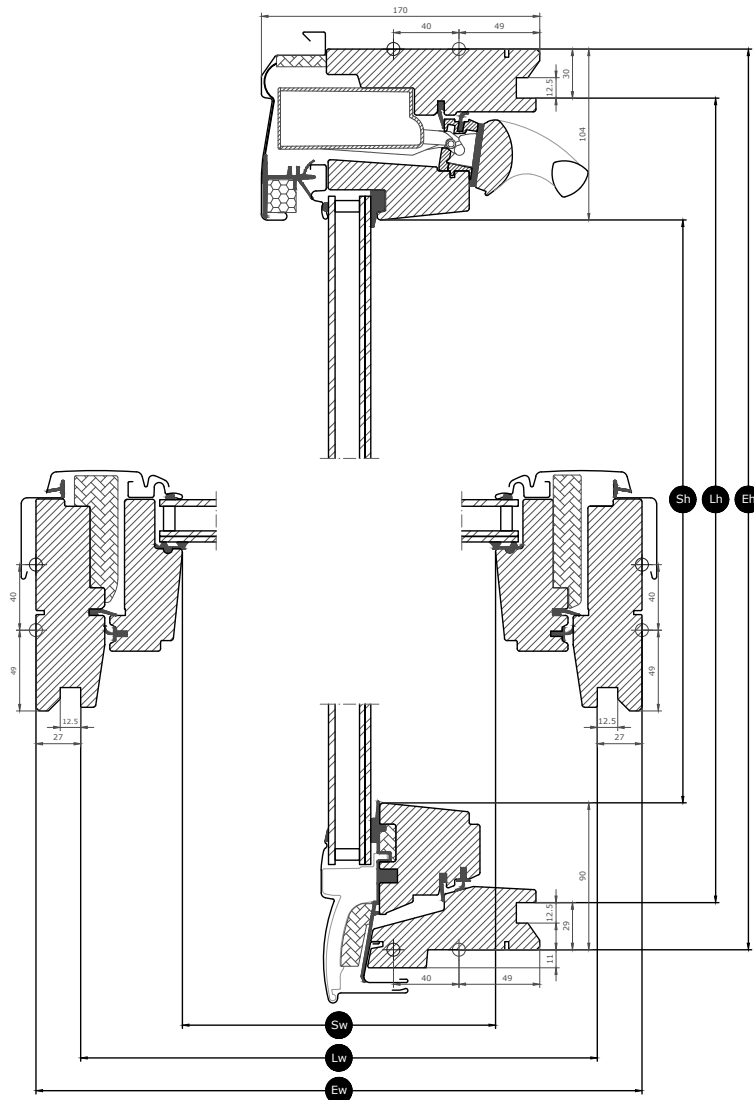







Please note that the view of the cross section is from bottom to top.



Width		BK--	CK--	FK--	MK--	PK--	SK--	UK--
Sw	Sash aperture width	293	371	481	601	763	961	1161
Lw	Distance between lining grooves, width	417	495	605	725	887	1085	1285
Ew	External frame width	472	550	660	780	942	1140	1340

Height		--01	--02	--04	--06	--08	--10	--25
Sh	Sash aperture height	504	584	784	984	1204	1406	356
Lh	Distance between lining grooves, height	639	719	919	1119	1339	1541	491
Eh	External frame height	698	778	978	1178	1398	1600	550

Glazing features

Glazing 70		
	Heat insulation The low energy glazing unit reduces heat loss through the window and enhanced indoor comfort.	$U_g = 1.0$
	Solar gain In colder climates and in rooms with large window areas, solar gain provides a better indoor climate during winter periods.	0.46
	Solar protection In warm climates and in rooms with large window areas, a sun protective glazing unit provides a better indoor climate during summer periods.	★★★★☆
	Security Thicker laminated inner glass increases resistance to manual attack (burglary).	★★★★☆
	Safety lamination Prevents glass from falling into the room in case of accidental breakage.	✓
	Toughened glass Adds strength to the outer glass surface to protect from wayward balls and extreme weather such as heavy storms and hail.	✓
	UV filter Protects your interior furnishings from fading due to the sun's harmful UV rays.	✓
	Rain noise reduction Rain noise reduction creates a barrier between the window and the weather outside for undisturbed moments during rainy days – or nights.	✓
	Easy-to-clean Dirt-repellent coating lets you spend less time cleaning and more time enjoying the view.	
	Anti-dew The anti-dew coating significantly reduces the days with dew on the outer glass and thus gives you a clear view.	

Glazing structure

Glazing unit	Variant composition
Double-glazed	6.8 mm laminated float glass - 16 mm Argon - 4 mm toughened glass

Technical values for the window

Overview of technical values for the product, covering among other, CE marking in accordance with EN 14351-1.

Window characteristics	Performance
Thermal transmittance	1.3 W/(m ² K)
Light transmittance	0.68
Total solar energy transmittance	0.46
Sound insulation	35(-1;-3)
Air permeability	4
External fire performance - British	AC
External fire performance - European	npd
Impact resistance	3
Load-bearing capacity of safety devices	✓
Reaction to fire	C-s1,d2
Resistance to snow load	See glazing composition
Resistance to wind load	C3 (>SK08: NPD)
Water tightness	E900

NPD: No performance determined

Visible features



Window operator, electric

Fully-integrated mains-powered motor is hidden from view in the top of the frame and is operated by remote control.



Integrated rain sensor

The window closes automatically in the event of rain or is prevented from opening thanks to the rain sensor.



Ventilation flap

The full-width ventilation flap can be used for ventilation even with a closed window. The ventilation flap is connected to the top sash with the lock casing.



Blind bracket, electric

Easily install electric blinds on the window without the need for extra tools. Simply click on the blinds in the pre-fitted brackets and they are connected for remote control.



Frame hinge, centre-pivot, side

Durable hinge design allows for reliable operation and enables the sash to be rotated for easy cleaning of the outer glass.



Barrel bolt

The barrel bolt can be placed into the integrated barrel bolt bushing to secure the window for cleaning of outer glass surface or for safe ventilation.



Interior insulation, frame top sides

Innovative ThermoTechnology™ insulation is integrated into the top frame sides of the window to increase energy-efficiency.



Data plate

Every VELUX roof window has a unique data plate with information that can be used to look up CE marking documentation, when purchasing accessories or in case of service or replacement.

Interior finish

Material Description	Clear lacquer Finished with triple coat, clear lacquered.	White-painted Finished with triple coat, white painted.
Colour code NCS, inner surface	No colour code	S 0500-N
Colour code nearest RAL, inner surface	No colour code	9003

Exterior covers

The availability of the variants listed below may change. For the most accurate and up to date information, please refer to the current product catalogue or price list.

Material Description	Aluminium, dark grey Dark grey	Titanium zinc	Untreated copper
Colour code NCS, outer surface	S 7500-N	No colour code	No colour code
Colour code nearest RAL, outer surface	7043	No colour code	No colour code

Cleaning and maintenance



To clean the outer glass surface from the inside, rotate sash manually and secure in cleaning position with barrel bolts.



VELUX repair and maintenance kits are available.

Guarantee period



All electrical components have a 3 year guarantee period. The full terms and conditions of the VELUX Product Guarantee are available on our website www.velux.co.uk or www.velux.ie

Flashings and installation products



Flashings

Install the VELUX roof window in virtually any roofing material by using genuine VELUX flashing solutions. Our flashings are designed specifically for the exact size and shape of the roof windows to create perfect, watertight fit. Flashings can also be used to combine multiple roof windows.

Installation products

Ensure a proper installation and an air- and watertight connection between the window and roof with VELUX installation products. All installation products are designed to perfectly fit the roof window for a reliable and durable result.

Blinds, awnings and shutters

Complete the VELUX roof window installation with roller shutters and awning blinds for heat protection and interior blinds for light dimming, blackout and insect protection. Choose from a wide range of manually operated or remote-controlled products that are made to fit the particular window type and size. Please contact your local VELUX sales company for more details about compatibility.

VELUX ACTIVE with NETATMO compatibility



Compatible with VELUX ACTIVE with NETATMO for a better indoor climate with sensor-based ventilation. Remote controlled via smartphone or voice.

Further information

We reserve the right to make technical changes.

For more information on our products, please visit <https://www.velux.co.uk> or <https://www.velux.ie>.

Technical information

VELUX electric roof window GGL	Installation and use	The window is classified in protection class IP44. The window operator is hidden in the top cover and functions at temperatures between -10 °C and +60 °C. Installation in rooms with a high level of humidity must comply with relevant regulations (contact a qualified electrician if necessary).
	Window opening	The window operator permits a maximum opening of 200mm within 35 seconds. Due to a shorter chain, small/special window sizes have a different window opening. Window opening for sizes --K01 and --K02 = 135 mm. Window opening for sizes --K25 and --K27 = 38 mm. The chain engages and disengages automatically when the window is closed.
	Compatibility	The roof window is based on radio frequency (RF) technology, 868 MHz range, and is compatible with other VELUX products with the io-homecontrol® logo. The roof window is prepared for subsequent installation of VELUX electric interior and exterior decoration and sunscreening products. It is compatible with all VELUX electric and solar decoration and suncreening products but we recommend using the electric ones. Connection to non-compatible products may cause damage or malfunction.
	Connection	The window is equipped with a 4m 2-core cable (H05VV-F) with a standard mains plug for connection to the mains supply (2.5m for the UK).
Pre-paired wall switch	Materials	ABS plastic, white (NCS S 1000-N)
	Size and weight description	8.2 cm x 8.2 cm x 1.7 cm, 0.125 kg.
	Installation and use	The wall switch is for indoor use only, between a minimum ambient temperature 5 °C and a maximum ambient temperature 45 °C. It can be used in a dry or humid environment (such as a living room or a bathroom). Radio frequency range: 300 m range open field. Depending on the building construction, the indoor range is approximately 30 m.
	Power consumption	2 x alkaline AAA (1.5V) batteries Expected battery lifetime: Up to 1 year.
Integrated rain sensor	Materials	Gold-coated sensor, Grey (RAL 7022)
	Size and weight description	N/A
	Power consumption	N/A
Window operator, electric	Materials	Motor casing of polybutulene terephthalate (PBT) with glass fibre, black (NCS S 9000-N). Stainless steel chain.
	Size and weight description	362 x 50 x 110 mm (W x H x D), 0.987 kg
	Power consumption	230/240 V a.c. – 50 Hz / 40 VA. Stand-by power consumption (including rain sensor): max 0.5 W. Additional stand-by power consumption for MML, SML or DML: 0.6 W. The operation of window and sunscreening product (3 cycles per day) will increase the energy consumption by approx 2 kWh/year.
	Motor capacity	Traction capacity: Min 225 N Pressure capacity: Min 150 N