

# VELUX manual top-hung roof window GPU

**VELUX®**



The VELUX bottom-operated, top-hung roof window GPU opens outwards to connect your home to the outside and bring panoramic views and a feeling of extra space inside. The durable, moisture-resistant finish looks great in any room and is ideal for humid rooms like kitchens.

- Open the window outwards up to 45° to enjoy a panoramic view and a feeling of space.
- Open the top control bar to the ventilation position for fresh air through a closed window.
- The glazing comes standard with premium features like safety lamination, toughened glass, UV filter and our unique rain noise reduction.
- Easily rotate the window 180° for safe cleaning of the outer glass from the inside.
- Adjust the bottom handle position to ventilate your home without opening the window.
- Removable and cleanable ventilation filter protects your home from dust and insects while ventilating.
- Quickly and easily add blinds by simply clicking them into the pre-fitted brackets.



## Application guidance

---

The window can be installed in roof pitches between 15° and 55° (75°) to the horizontal



Manual bottom-operated, top-hung roof windows open outwards for an unobstructed, panoramic view. To get the full benefit of the top-hung function, we recommend an installation height that allows for a clear sight line to the outside from both a standing and seated position. Please note that the optimum window height depends on the roof pitch.

## Available sizes and daylight area

---

The size overview shows the availability across the different glazing variants. Please note that the individual glazing variant may not be available in all the sizes shown.

<STEPTABLE O="Product-732-0" OT="Product" TF=" " TT="27997589" VC="Context4"  
VO="26405707" W="Approved" />

All measurements are in mm. ( ) = Effective daylight area, m<sup>2</sup>



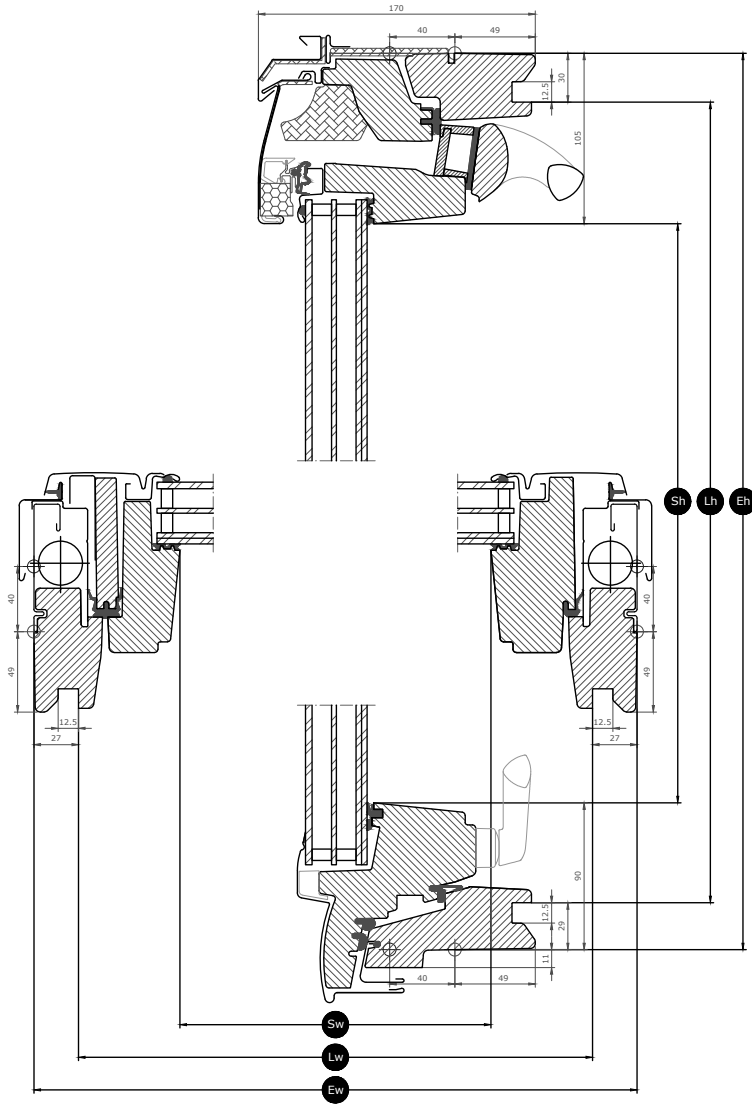





# Cross section dimensions



<STEPTABLE O="Product-732-0" OT="Product" TF=" " TT="32601067" VC="Context4" VO="26405707" W="Approved" />

<STEPTABLE O="Product-732-0" OT="Product" TF=" " TT="32490867" VC="Context4" VO="26405707" W="Approved" />

## Glazing features

 <b>Solar protection</b>
 <b>Security</b>
 <b>Safety lamination</b>
 <b>Toughened glass</b>
 <b>UV filter</b>
 <b>Rain noise reduction</b>
 <b>Easy-to-clean</b>
 <b>Anti-dew</b>

### Glazing structure

Glazing variant	Glazing unit	Variant composition
Glazing 62SG	Triple-glazed	6.8 mm laminated float glass - 11 mm Krypton - 3 mm heat strengthened glass - 11 mm Krypton - 8 mm toughened glass

## Technical values for the window

Overview of technical values for the product, covering among other, CE marking in accordance with EN 14351-1.

		<b>Glazing 62SG</b>
Window characteristics	Performance	
Thermal transmittance	0.96 W/(m <sup>2</sup> K)	
Light transmittance	0.68	
Total solar energy transmittance	0.47	
Sound insulation	42(-2;-5)	
Air permeability	4 (PK10: 3)	
External fire performance - British	AA	
External fire performance - European	npd	
Impact resistance	3	
Load-bearing capacity of safety devices	✓	
Reaction to fire	D-s3,d2	
Resistance to snow load	**	
Resistance to wind load	C3 (>SK08: NPD)	
Water tightness	E900	

Resistance to snow load = \*\* See glazing composition

NPD: No performance determined

<STEPTABLE 0="Product-732-0" OT="Product" TF=" " TT="26341590" VC="Context4" VO="26405707" W="Approved" />

## Interior finish

---

Material Description	White maintenance-free Finished with polyurethane lacquer.
Colour code NCS, inner surface	S 0500-N
Colour code nearest RAL, inner surface	9003

## Exterior covers

---

Material Description	Aluminium, dark grey Dark grey	Titanium zinc	Untreated copper
Colour code NCS, outer surface	S 7500-N	No colour code	
Colour code nearest RAL, outer surface	7043	No colour code	

## Cleaning and maintenance

---

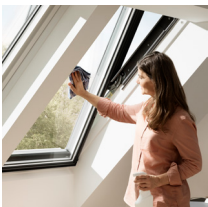

To clean the outer glass surface from the inside, rotate sash and secure in cleaning position with barrel bolts.



VELUX repair and maintenance kits are available.

## Guarantee period

---



The full terms and conditions of the VELUX Product Guarantee are available on our website [www.velux.co.uk](http://www.velux.co.uk) or [www.velux.ie](http://www.velux.ie)

## Flashings and installation products

---



### Flashings

Install the VELUX roof window in virtually any roofing material by using genuine VELUX flashing solutions. Our flashings are designed specifically for the exact size and shape of the roof windows to create perfect, watertight fit. Flashings can also be used to combine multiple roof windows.

### Installation products

Ensure a proper installation and an air- and watertight connection between the window and roof with VELUX installation products. All installation products are designed to perfectly fit the roof window for a reliable and durable result.

## Further information

---

We reserve the right to make technical changes.

For more information on our products, please visit <https://www.velux.co.uk> or <https://www.velux.ie>.

## Technical information

---

<STEPTABLE O="Product-732-0" OT="Product" TF=" " TT="834558" VC="Context4" V0="26405707" W="Approved" />