

# VELUX smoke ventilation roof window GGL

**VELUX®**

Glazing 70



Increase personal safety and building safety in the event of fire with a VELUX smoke ventilation window. The window automatically opens when smoke is detected to quickly release smoke and excess heat and meets EU requirements. Can also be opened to let in fresh air for comfort ventilation. Exterior design matches other VELUX roof windows. Requires a control system to be activated.

- Opens to full fire position in just 60 seconds when smoke ventilation is activated.
- Maintain the exterior look of your building with VELUX smoke ventilation windows.
- Fully complies with current and expected future CE standards and regulations.
- Wind deflector (add-on) enhances aerodynamic free areas to quickly let out heat and smoke. (Required in certain types of buildings).
- Fully compatible with VELUX smoke ventilation control systems KFX 210-214 or KFC 210/220 that are to be purchased separately.
- Prepared for connection to optional non-VELUX alarm systems for central control.
- Comes in a wide range of sizes for installation in virtually any building project.



## Application guidance

The window can be installed in roof pitches between 15° and 60° to the horizontal.

Note: Max 60° refers to EU standard measuring requirements.

In roof pitches between 60° and 90°, local building regulations may require a wind direction sensor to prevent the window from opening and letting in air.

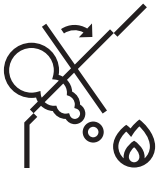

A VELUX smoke ventilation window is designed to quickly release smoke and excess heat. The window comes complete with a smoke ventilation motor and is compliant with all EU requirements. For operation and automatic opening, a VELUX smoke ventilation control system KFX 210-214 or KFC 210/220 must be purchased separately. The VELUX smoke ventilation control system can enable several functions including automatic opening of the smoke ventilation window. It can also be opened to let in fresh air for improved indoor comfort.











## Available sizes and daylight area

	780 mm	942 mm	1140 mm	1340 mm
978 mm	GGL MK04 (0.47) []			GGL UK04 (0.91) []
1178 mm	GGL MK06 (0.59) []	GGL PK06 (0.75) []	GGL SK06 (0.95) []	
1398 mm	GGL MK08 (0.72) []	GGL PK08 (0.92) []	GGL SK08 (1.16) []	GGL UK08 (1.40) []

All measurements are in mm. ( ) = Effective daylight area, m<sup>2</sup> [] = Geometric free area, m<sup>2</sup>



## Glazing features

Glazing 70		
	<b>Heat insulation</b> The low energy glazing unit reduces heat loss through the window and enhanced indoor comfort.	$U_g = 1.0$
	<b>Solar gain</b> In colder climates and in rooms with large window areas, solar gain provides a better indoor climate during winter periods.	0.46
	<b>Solar protection</b> In warm climates and in rooms with large window areas, a sun protective glazing unit provides a better indoor climate during summer periods.	★★★★☆
	<b>Security</b> Thicker laminated inner glass increases resistance to manual attack (burglary).	★★★★☆
	<b>Safety lamination</b> Prevents glass from falling into the room in case of accidental breakage.	✓
	<b>Toughened glass</b> Adds strength to the outer glass surface to protect from wayward balls and extreme weather such as heavy storms and hail.	✓
	<b>UV filter</b> Protects your interior furnishings from fading due to the sun's harmful UV rays.	✓
	<b>Rain noise reduction</b> Rain noise reduction creates a barrier between the window and the weather outside for undisturbed moments during rainy days – or nights.	✓
	<b>Easy-to-clean</b> Dirt-repellent coating lets you spend less time cleaning and more time enjoying the view.	
	<b>Anti-dew</b> The anti-dew coating significantly reduces the days with dew on the outer glass and thus gives you a clear view.	

### Glazing structure

Glazing unit	Variant composition
Double-glazed	6.8 mm laminated float glass - 16 mm Argon - 4 mm toughened glass

## Technical values for the window

Overview of technical values for the product, covering among other, CE marking in accordance with EN 14351-1 and EN 12101-2.

Window characteristics	Performance
Thermal transmittance	1.3 W/(m <sup>2</sup> K)
Light transmittance	0.68
Total solar energy transmittance	0.46
Sound insulation	35(-1;-3)
Air permeability	3
External fire performance - British	AC
External fire performance - European	npd
Impact resistance	npd
Load-bearing capacity of safety devices	npd
Reaction to fire	C-s1,d2
Resistance to snow load	See glazing composition
Resistance to wind load	C3 (>SK08: NPD)
Water tightness	E900
Low ambient temperature	T(-15)
Mechanical stability	√
Nominal activation system/sensitivity	√
Opening under load	SL 1000
Operational reliability	Re 1000 + 10000
Heat resistance	B300
Resistance to wind-induced vibration (Where included)	√
Response delay (Response time)	< 60 s
Stability under wind load	WL 3000 (UK08: WL1500)

NPD: No performance determined

	Aerodynamic smoke ventilation area with KFD (Aa)	Aerodynamic smoke ventilation area without KFD (Aa)	Geometric smoke ventilation area Av
MK04	0.36 m <sup>2</sup>	0.19 m <sup>2</sup>	0.63 m <sup>2</sup>
MK06	0.46 m <sup>2</sup>	0.29 m <sup>2</sup>	0.77 m <sup>2</sup>
MK08	0.59 m <sup>2</sup>	0.43 m <sup>2</sup>	0.92 m <sup>2</sup>
PK06	0.53 m <sup>2</sup>	0.30 m <sup>2</sup>	0.95 m <sup>2</sup>
PK08	0.68 m <sup>2</sup>	0.46 m <sup>2</sup>	1.14 m <sup>2</sup>
SK06	0.61 m <sup>2</sup>	0.28 m <sup>2</sup>	1.17 m <sup>2</sup>
SK08	0.77 m <sup>2</sup>	0.44 m <sup>2</sup>	1.40 m <sup>2</sup>
UK04	0.54 m <sup>2</sup>	0.16 m <sup>2</sup>	1.13 m <sup>2</sup>
UK08	0.83 m <sup>2</sup>	0.38 m <sup>2</sup>	1.67 m <sup>2</sup>

## Visible features

---

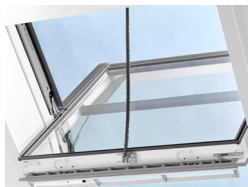

### Window operator, smoke ventilation

Fully-integrated electric motor in the top of the frame is operated by the control system or when the smoke detector detects smoke.



### Rain sensor (add on)

The window closes automatically in the event of rain. This function is overridden in case of fire.



### Frame hinge, centre-pivot, side

Durable hinge design allows for reliable operation and enables the sash to be rotated for easy cleaning of the outer glass.



### Barrel bolt

The barrel bolt can be placed into the integrated barrel bolt bushing to secure the window for cleaning of outer glass surface or for safe ventilation.



### Interior insulation, frame top sides

Innovative ThermoTechnology™ insulation is integrated into the top frame sides of the window to increase energy-efficiency.



### Data plate

Every VELUX roof window has a unique data plate with information that can be used to look up CE marking documentation, when purchasing accessories or in case of service or replacement.

## Interior finish

Material Description	Clear lacquer Finished with triple coat, clear lacquered.	White-painted Finished with triple coat, white painted.
Colour code NCS, inner surface	No colour code	S 0500-N
Colour code nearest RAL, inner surface	No colour code	9003

## Exterior covers

The availability of the variants listed below may change. For the most accurate and up to date information, please refer to the current product catalogue or price list.

Material Description	Aluminium, dark grey Dark grey
Colour code NCS, outer surface	S 7500-N
Colour code nearest RAL, outer surface	7043

## Cleaning and maintenance



Frame and sash can be cleaned with ordinary household cleaners. If necessary, the outer glass surface is cleaned from the outside.



VELUX repair and maintenance kits are available.

## Guarantee period



All electrical components have a 3 year guarantee period. The full terms and conditions of the VELUX Product Guarantee are available on our website [www.velux.co.uk](http://www.velux.co.uk) or [www.velux.ie](http://www.velux.ie)

## Flashings and installation products

---



### **Flashings**

Install the VELUX roof window in virtually any roofing material by using genuine VELUX flashing solutions. Our flashings are designed specifically for the exact size and shape of the roof windows to create perfect, watertight fit. Flashings can also be used to combine multiple roof windows.

### **Installation products**

Ensure a proper installation and an air- and watertight connection between the window and roof with VELUX installation products. All installation products are designed to perfectly fit the roof window for a reliable and durable result.

## Further information

---

We reserve the right to make technical changes.

For more information on our products, please visit <https://www.velux.co.uk> or <https://www.velux.ie>.

## Technical information

<b>VELUX smoke ventilation roof window GGL</b>	<b>Installation and use</b>	<p>The window comes complete with installation instructions, two-level installation brackets and screws (in Beipack) to be used for installation. The window is classified in protection class IP44. The window operator is hidden in the top cover and functions at temperatures between -10 °C and +60 °C.</p> <p>Installation in rooms with a high level of humidity must comply with relevant regulations (contact a qualified electrician if necessary).</p>
	<b>Window opening</b>	<p>Opens (electrically) 200 mm for comfort ventilation. Opens approximately 90° when activated by smoke ventilation system.</p>
	<b>Compatibility</b>	<p>Compatible with VELUX smoke ventilation control systems KFX 210-214 or KFC 210/220. For safety reasons, It is not recommended to fit any blinds or shutters on our smoke ventilation roof windows. Not compatible with io-homecontrol®</p>
	<b>Connection</b>	<p>The motor is supplied with a 4 m long, 2-wire, silicone cable (2 x 0.75 mm<sup>2</sup>).</p> <p>The cable can be connected to control units KFX 210-214 or KFC 210/220 with an isolated 3-core cable to allow for cable monitoring. The maximum cable length and prescribed cross-sectional sizes are:</p> <p>Length up to 33 m: 3 x 1,5 mm<sup>2</sup>            Length up to 56 m: 3 x 2,5 mm<sup>2</sup>            Length up to 89 m: 3 x 4 mm<sup>2</sup>            Length up to 134 m: 3 x 6 mm<sup>2</sup></p>
<b>Rain sensor (add on)</b>	<b>Materials</b>	Gold-coated sensor, Grey (RAL 7022)
	<b>Size and weight description</b>	N/A
	<b>Power consumption</b>	24V DC
<b>Window operator, smoke ventilation</b>	<b>Materials</b>	Zinc housing, Signal grey, anti-slip bow chain of steel, Dacromet coating
	<b>Size and weight description</b>	576 x 124 x 68 mm (W x H x D) – 3,654 kg
	<b>Power consumption</b>	If the window is connected to an external control system, the requirements to the connection are 24 V dc and 2.5 A.
	<b>Motor capacity</b>	Traction capacity: Min 600 N Pressure capacity: Min 500 N