

VELUX electric roof window GGU

Glazing 66SG



The VELUX electric, centre-pivot roof window GGU is a wired solution that operates remotely using a control pad – perfect for both in- and out-of-reach installations. The roof window has an integrated motor and a rain sensor that automatically closes the window if it rains. Moisture-resistance makes it ideal for kitchens and bathrooms.

- Rain sensor automatically closes the window in the event of rain.
- Electric-powered to allow for complete, seamless integration of your roof window into your home.
- The motor is hidden in the top cover and totally invisible from view.
- Entrapment control detects objects in the path of the window.
- Compatible with VELUX ACTIVE with NETATMO for a better indoor climate with sensor-based ventilation. Remote controlled via smartphone or voice.
- Silent motor keeps rooms quiet for sleeping children or simply for improved well-being.
- The io-homecontrol® platform ensures very high and future-proof system security.



Application guidance

The window can be installed in roof pitches between 15° and 90° to the horizontal.



VELUX electric and solar roof windows are easily operated by a control pad, providing fresh air at the touch of a button. Perfect for both within-reach and out-of-reach applications where extra comfort and convenient operation is required. For optimum daylight, choose larger windows for lower roof pitches.

Available sizes and daylight area

	780 mm
1398	GGU MK08 0.72 m ²

All measurements are in mm. () = Effective daylight area, m²



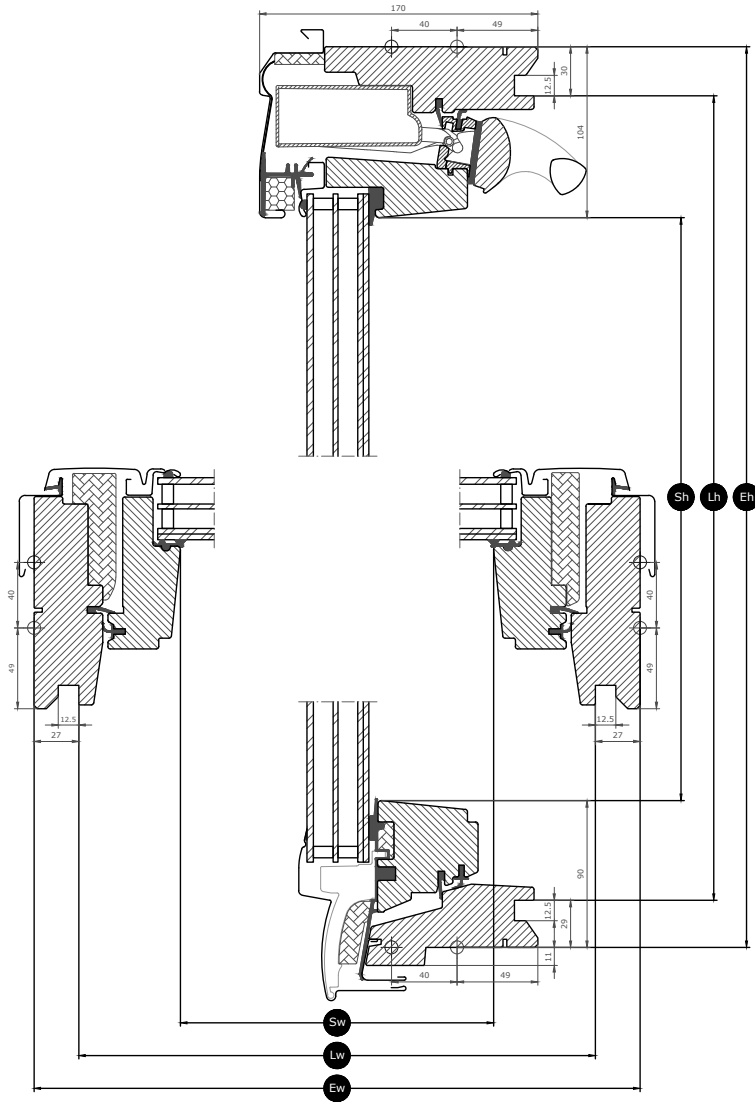





Cross section dimensions

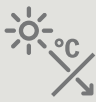

<STEPTABLE O="Product-3986-0" OT="Product" TF=" " TT="478978" VC="Context4" VO="26405707" W="Approved" />

<STEPTABLE O="Product-3986-0" OT="Product" TF=" " TT="478966" VC="Context4" VO="26405707" W="Approved" />

Glazing features

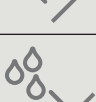
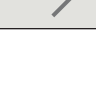
Glazing 66SG		
	Heat insulation The low energy glazing unit reduces heat loss through the window and enhanced indoor comfort.	$U_g = 0.6$
	Solar gain In colder climates and in rooms with large window areas, solar gain provides a better indoor climate during winter periods.	0.44
	Solar protection In warm climates and in rooms with large window areas, a sun protective glazing unit provides a better indoor climate during summer periods.	★★★★☆
	Security Thicker laminated inner glass increases resistance to manual attack (burglary).	★★★★☆
	Safety lamination Prevents glass from falling into the room in case of accidental breakage.	✓
	Toughened glass Adds strength to the outer glass surface to protect from wayward balls and extreme weather such as heavy storms and hail.	✓
	UV filter Protects your interior furnishings from fading due to the sun's harmful UV rays.	✓
	Rain noise reduction Rain noise reduction creates a barrier between the window and the weather outside for undisturbed moments during rainy days – or nights.	✓
	Easy-to-clean Dirt-repellent coating lets you spend less time cleaning and more time enjoying the view.	✓
	Anti-dew The anti-dew coating significantly reduces the days with dew on the outer glass and thus gives you a clear view.	✓

Glazing structure

Glazing unit	Variant composition
Triple-glazed	6.8mm laminated float glass - 13mm Argon - 3mm heat strengthened glass - 13mm Argon - 4mm toughened glass

Technical values for the window

Overview of technical values for the product, covering among other, CE marking in accordance with EN 14351-1.

Window characteristics	Performance
Thermal transmittance	1.0 W/(m ² K)
Light transmittance	0.62
Total solar energy transmittance	0.44
Sound insulation	37(-2;-4)
Air permeability	4 (PK10: 3)
External fire performance - British	AC
External fire performance - European	npd
Impact resistance	3
Load-bearing capacity of safety devices	√
Reaction to fire	D-s3,d2
Resistance to snow load	See glazing composition
Resistance to wind load	C3 (>SK08: NPD)
Water tightness	E900

NPD: No performance determined

Visible features



Window operator, electric

Fully-integrated mains-powered motor is hidden from view in the top of the frame and is operated by remote control.

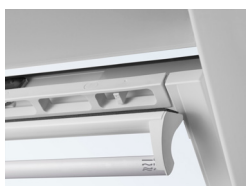

Ventilation flap

The full-width ventilation flap can be used for ventilation even with a closed window.



Blind bracket, electric

Easily install electric blinds on the window without the need for extra tools. Simply click on the blinds in the pre-fitted brackets and they are connected for remote control.



Frame hinge, centre-pivot, side

Durable hinge design allows for reliable operation and enables the sash to be rotated for easy cleaning of the outer glass.



Barrel bolt

The barrel bolt can be placed into the integrated barrel bolt bushing to secure the window for cleaning of outer glass surface or for safe ventilation.

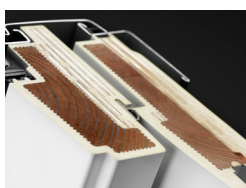

Excellent insulation

High performance insulation materials in the window construction and thermally modified timber core increase the energy efficiency of the window.



Data plate

Every VELUX roof window has a unique data plate with information that can be used to look up CE marking documentation, when purchasing accessories or in case of service or replacement.

Interior finish

Material Description	White maintenance-free Finished with polyurethane lacquer.
Colour code NCS, inner surface	S 0500-N
Colour code nearest RAL, inner surface	9003

Exterior covers

Material Description	Aluminium, dark grey Dark grey
Colour code NCS, outer surface	S 7500-N
Colour code nearest RAL, outer surface	7043

Cleaning and maintenance



To clean the outer glass surface from the inside, rotate sash and secure in cleaning position with barrel bolts.



VELUX repair and maintenance kits are available.

Guarantee period



All electrical components have a 3 year guarantee period.

Flashings and installation products



Flashings

Install the VELUX roof window in virtually any roofing material by using genuine VELUX flashing solutions. Our flashings are designed specifically for the exact size and shape of the roof windows to create perfect, watertight fit. Flashings can also be used to combine multiple roof windows.

Installation products

Ensure a proper installation and an air- and watertight connection between the window and roof with VELUX installation products. All installation products are designed to perfectly fit the roof window for a reliable and durable result.

Blinds, awnings and shutters

Complete the VELUX roof window installation with roller shutters and awning blinds for heat protection and interior blinds for light dimming, blackout and insect protection. Choose from a wide range of manually operated or remote-controlled products that are made to fit the particular window type and size. Please contact your local VELUX sales company for more details about compatibility.

VELUX ACTIVE with NETATMO compatible



Compatible with VELUX ACTIVE with NETATMO for a better indoor climate with sensor-based ventilation. Remote controlled via smartphone or voice.

Further information

We reserve the right to make technical changes.

For more information on our products, please visit <https://www.velux.co.uk> or <https://www.velux.ie>.

Technical information

VELUX electric roof window GGU	Installation and use	The window is classified in protection class IP44. The window operator is hidden in the top cover and functions at temperatures between -10 °C and +60 °C. Installation in rooms with a high level of humidity must comply with relevant regulations (contact a qualified electrician if necessary).
	Window opening	The window operator permits a maximum opening of 200 mm within 35 seconds. Due to a shorter chain, small/special window sizes have a different window opening. Window opening for sizes --K01 and --K02 = 135 mm. Window opening for sizes --K25 and --K27 = 38 mm. The chain engages and disengages automatically when the window is closed.
	Compatibility	The roof window is based on radio frequency (RF) technology, 868 MHz range, and is compatible with other VELUX products with the io-homecontrol® logo. The roof window is prepared for subsequent installation of VELUX electric interior and exterior decoration and sunscreening products. It is compatible with all VELUX electric and solar decoration and sunscreening products but we recommend using the electric ones. Connection to non-compatible products may cause damage or malfunction.
Control pad	Connection	The window is equipped with a 7.5 m 2-core cable (H05VV-F) with a standard mains plug for connection to the mains supply (2.5 m for the UK).
	Materials	ABS plastic, white (NCS S 1000-N), black (RAL 9005) and metallic grey.
	Size and weight description	95 x 95 x 23 mm (W x H x D), 114 g (with batteries 184 g).
Integrated rain sensor	Installation and use	The control pad is for indoor use, maximum ambient temperature 50 °C. Radio frequency range: 200 m free field. Depending on building construction, the indoor range is approximately 20 m.
	Power consumption	3 x alkaline AA/LR6 (1.5 V) batteries. Expected battery lifetime: Approximately 1 year.
	Materials	Gold-coated sensor, Grey (RAL 7022)
Window operator, electric	Size and weight description	N/A
	Power consumption	N/A
	Materials	Motor casing of polybutulene terephthalate (PBT) with glass fibre, black (NCS S 9000-N). Stainless steel chain.
Window operator, electric	Size and weight description	362 x 50 x 110 mm (W x H x D), 0.987 kg
	Power consumption	230/240 V a.c. – 50 Hz / 40 VA. Stand-by power consumption (including rain sensor): max 0.5 W. Additional stand-by power consumption for MML, SML or DML: 0.6 W. The operation of window and suncreening product (3 cycles per day) will increase the energy consumption by approx 2 kWh/year.
	Motor capacity	Traction capacity: Min 225 N Pressure capacity: Min 150 N