

VELUX electric roof window GPU

Glazing 70



The VELUX electric top-hung roof window gives a panorama view and the feeling of space combined with convenient electrical operation for installation within reach.

- The electrical top-hung window provides a panorama view combined with convenient electrical operation.
- The wall switch is pre-paired to work with your window right out of the box.
- Rain sensor automatically closes the window in the event of rain.
- Entrapment control detects objects in the bottom of the window
- The motors are hidden in the side frames and totally invisible from view.
- Easily open and close the roof window – even with furniture placed underneath.
- Electric-powered to allow for complete, seamless integration of your roof window into your home.



Application guidance

The window can be installed in roof pitches between 15° and 65° to the horizontal.



VELUX electric top-hung roof windows effortlessly open wide to create a balcony-like feeling with uninterrupted panoramic views. You can easily open the window using the convenient remote control, or add VELUX ACTIVE with NETATMO for a healthier indoor climate that can be controlled via the smartphone app.

Available sizes and daylight area

	660 mm	780 mm	942 mm	1140 mm
1178	GPU FK06 (0.47) [0.60]	GPU MK06 (0.59) [0.72]	GPU PK06 (0.75) [0.89]	GPU SK06 (0.95) [1.09]
1398	GPU FK08 (0.58) [0.72]	GPU MK08 (0.72) [0.87]	GPU PK08 (0.91) [1.08]	GPU SK08 (1.14) [1.32]

All measurements are in mm. () = Effective daylight area, m² [] = Geometric free area, m²

Cross section dimensions



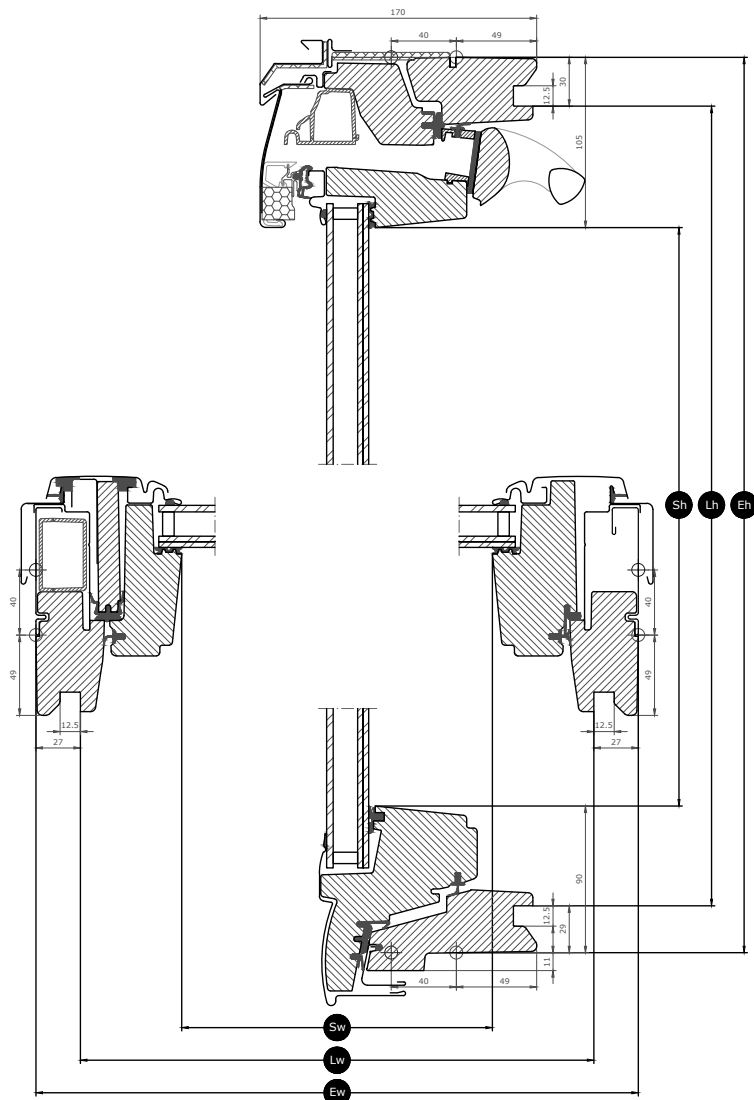







Please note that the view of the cross section is from bottom to top.



Width		FK--	MK--	PK--	SK--
Sw	Sash aperture width	481	601	763	961
Lw	Distance between lining grooves, width	605	725	887	1085
Ew	External frame width	660	780	942	1140

Height		--06	--08
Sh	Sash aperture height	984	1204
Lh	Distance between lining grooves, height	1119	1339
Eh	External frame height	1178	1398

Glazing features

Glazing 70		
	Heat insulation The low energy glazing unit reduces heat loss through the window and enhanced indoor comfort.	$U_g = 1.0$
	Solar gain In colder climates and in rooms with large window areas, solar gain provides a better indoor climate during winter periods.	0.46
	Solar protection In warm climates and in rooms with large window areas, a sun protective glazing unit provides a better indoor climate during summer periods.	★★★★☆
	Security Thicker laminated inner glass increases resistance to manual attack (burglary).	★★★★☆
	Safety lamination Prevents glass from falling into the room in case of accidental breakage.	✓
	Toughened glass Adds strength to the outer glass surface to protect from wayward balls and extreme weather such as heavy storms and hail.	✓
	UV filter Protects your interior furnishings from fading due to the sun's harmful UV rays.	✓
	Rain noise reduction Rain noise reduction creates a barrier between the window and the weather outside for undisturbed moments during rainy days – or nights.	✓
	Easy-to-clean Dirt-repellent coating lets you spend less time cleaning and more time enjoying the view.	
	Anti-dew The anti-dew coating significantly reduces the days with dew on the outer glass and thus gives you a clear view.	

Glazing structure

Glazing unit	Variant composition
Double-glazed	6.8 mm laminated float glass - 16 mm Argon - 4 mm toughened glass

Technical values for the window

Overview of technical values for the product, covering among other, CE marking in accordance with EN 14351-1.

Window characteristics	Performance
Thermal transmittance	1.3 W/(m ² K)
Light transmittance	0.68
Total solar energy transmittance	0.46
Sound insulation	35(-1;_3)
Air permeability	4 (PK10: 3)
External fire performance - British	npd
External fire performance - European	npd
Impact resistance	npd
Load-bearing capacity of safety devices	✓
Reaction to fire	D-s3,d2
Resistance to snow load	See glazing composition
Resistance to wind load	C3 (>SK08: NPD)
Water tightness	E900

NPD: No performance determined

Visible features



Motor, electric, top-hung

Fully integrated mains-powered motors are hidden from view in the side frames and activated by remote control.



Integrated rain sensor

The window closes automatically in the event of rain or is prevented from opening thanks to the rain sensor.



Ventilation flap

The full-width ventilation flap can be used for ventilation even with a closed window.



Blind bracket, manual

Easily install blinds on the window without the need for extra tools. Simply click on the blind in the pre-fitted brackets.



Frame hinge, centre-pivot, side

Durable hinge design allows for reliable operation and enables the sash to be rotated for easy cleaning of the outer glass.



Excellent insulation

High performance insulation materials in the window construction and thermally modified timber core increase the energy efficiency of the window.



Gas spring, top-hung, electric

Gas springs are integrated in the opening design of the electric top-hung roof window.



Data plate

Every VELUX roof window has a unique data plate with information that can be used to look up CE marking documentation, when purchasing accessories or in case of service or replacement.

Interior finish

Material Description	White maintenance-free Finished with polyurethane lacquer.
Colour code NCS, inner surface	S 0500-N
Colour code nearest RAL, inner surface	9003

Exterior covers

The availability of the variants listed below may change. For the most accurate and up to date information, please refer to the current product catalogue or price list.

Material Description	Aluminium, dark grey Dark grey
Colour code NCS, outer surface	S 7500-N
Colour code nearest RAL, outer surface	7043

Cleaning and maintenance



To clean the outer glass surface from the inside, ensure the window is closed. From closed position, the window can be opened manually and rotated to be secured in cleaning position with barrel bolts.



VELUX repair and maintenance kits are available.

Guarantee period



All electrical components have a 3 year guarantee period. The full terms and conditions of the VELUX Product Guarantee are available on our website www.velux.co.uk or www.velux.ie

Flashings and installation products



Flashings

Install the VELUX roof window in virtually any roofing material by using genuine VELUX flashing solutions. Our flashings are designed specifically for the exact size and shape of the roof windows to create perfect, watertight fit. Flashings can also be used to combine multiple roof windows.

Installation products

Ensure a proper installation and an air- and watertight connection between the window and roof with VELUX installation products. All installation products are designed to perfectly fit the roof window for a reliable and durable result.

Blinds, awnings and shutters

Complete the VELUX roof window installation with roller shutters and awning blinds for heat protection and interior blinds for light dimming, blackout and insect protection. Choose from a wide range of manually operated or remote-controlled products that are made to fit the particular window type and size. Please contact your local VELUX sales company for more details about compatibility.

VELUX ACTIVE with NETATMO compatibility



Compatible with VELUX ACTIVE with NETATMO for a better indoor climate with sensor-based ventilation. Remote controlled via smartphone or voice.

Further information

We reserve the right to make technical changes.

For more information on our products, please visit <https://www.velux.co.uk> or <https://www.velux.ie>.

Technical information

VELUX electric roof window GPU	Installation and use	The window is classified in protection class IP44. The window operators are integrated in the side frames and function at temperatures between -10 °C and +60 °C. Installation in rooms with a high level of humidity must comply with relevant regulations (contact a qualified electrician if necessary).
	Window opening	The window operator permits a maximum opening of 45° of the sash. It is possible to adjust the sash to open to horizontal position (+/- 2 degrees of accuracy) in roof pitches less than 45°.
	Compatibility	<p>The roof window is based on radio frequency (RF) technology, 868 MHz range, and is compatible with other VELUX products with the io-homecontrol® logo.</p> <p>The window comes complete with pre-fitted brackets to match interior standard sunscreening. (Be aware there is no bracket powered for electrical blinds: -M- so only manual and solar interior blinds can be installed).</p> <p>GPU electric is compatible with: Roller blinds, type: R-- (Not mains-powered) Pleated blinds, type: F-- (Not mains-powered) Blackout blinds, type: D-- (Not mains-powered) Venetian blinds, type: P-- Insect roller screens, type: ZIL</p> <p>Following exterior suncreening can also be installed: Roller shutters, type: SMH Awning blinds, type: MML and MSL. Both blinds require installation kit ZOZ 229S Soft shutter, type: SSS + installation kit ZOZ 229S</p> <p>Connection to non-compatible products may cause damage or malfunction.</p>
Pre-paired wall switch	Connection	The window is equipped with a 4 m 2-core cable (H05VV-F) with a standard mains plug for connection to the mains supply (2.5 m for the UK).
	Materials	ABS plastic, white (NCS S 1000-N)
	Size and weight description	8.2 cm x 8.2 cm x 1.7 cm, 0.125 kg.
Integrated rain sensor	Installation and use	<p>The wall switch is for indoor use only, between a minimum ambient temperature 5 °C and a maximum ambient temperature 45 °C. It can be used in a dry or humid environment (such as a living room or a bathroom).</p> <p>Radio frequency range: 300 m range open field. Depending on the building construction, the indoor range is approximately 30 m.</p>
	Power consumption	2 x alkaline AAA (1.5V) batteries Expected battery lifetime: Up to 1 year.
	Materials	Gold-coated sensor, Grey (RAL 7022)
Motor, electric, top-hung	Size and weight description	N/A
	Power consumption	N/A
	Materials	PPS-40GF, Black
Motor, electric, top-hung	Size and weight description	41.15 x 49.5 x 32.5 mm, 1.032 kg
	Power consumption	230VAC – 50Hz / 60W. Stand-by power consumption (including rain sensor; no heating): 0.5 W. Stand-by power consumption (including rain sensor; with heating): 1.1 W.
	Motor capacity	Pressure capacity: 800N Traction capacity: 900N