

VELUX electric roof window GGL

VELUX®

Glazing 86



The VELUX electric 230 V, centre-pivot roof window GGL is a wired solution that can be connected to any switch range or smart home system – perfect for both in-reach and out-of-reach installations. The roof window is designed for extreme weather conditions and has an integrated and silent motor. If it rains, the rain sensor automatically closes the window.

- The window connects seamlessly to any switch range and integrates effortlessly with any building management system
- Connect our electrical motor directly to your mains grid and improve your indoor air quality instantly.
- Rain sensor automatically closes the window in the event of rain.
- Mains-powered to allow for complete, seamless integration of your roof window into your home.
- The motor is hidden in the top cover and totally invisible from view.
- Entrapment control detects objects in the path of the window.
- Silent motor keeps rooms quiet for sleeping children or simply for improved well-being.



Application guidance

The window can be installed in roof pitches between 15° and 90° to the horizontal.



VELUX electric 230 V roof windows are easily integrated into any smart home control system or switch range. Please consult our wiring diagram for more detailed information. Perfect for both within-reach and out-of-reach applications where extra comfort and convenient operation are required. For optimum view, choose longer roof windows for lower roof pitches.

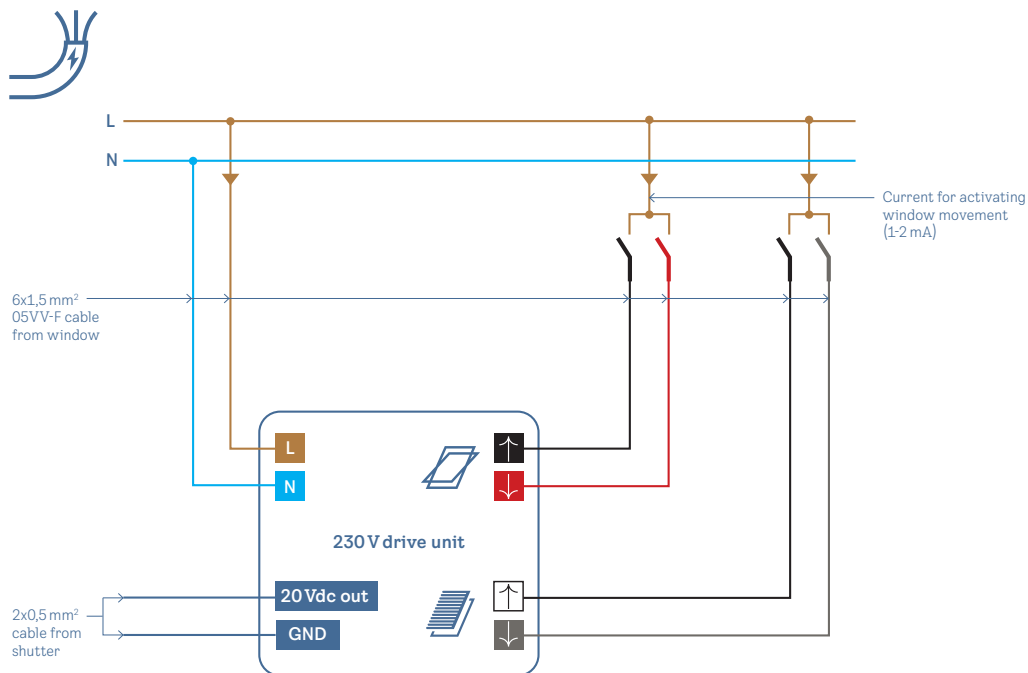

Available sizes and daylight area

	660 mm	780 mm	942 mm	1140 mm
1178	GGL FK06 (0.47) [0.24]	GGL MK06 (0.59) [0.28]	GGL PK06 (0.75) [0.33]	GGL SK06 (0.95) [0.39]
	GGL FK08 (0.58) [0.24]	GGL MK08 (0.72) [0.28]	GGL PK08 (0.92) [0.33]	GGL SK08 (1.16) [0.39]

All measurements are in mm. () = Effective daylight area, m² [] = Geometric free area, m²

Cross section dimensions



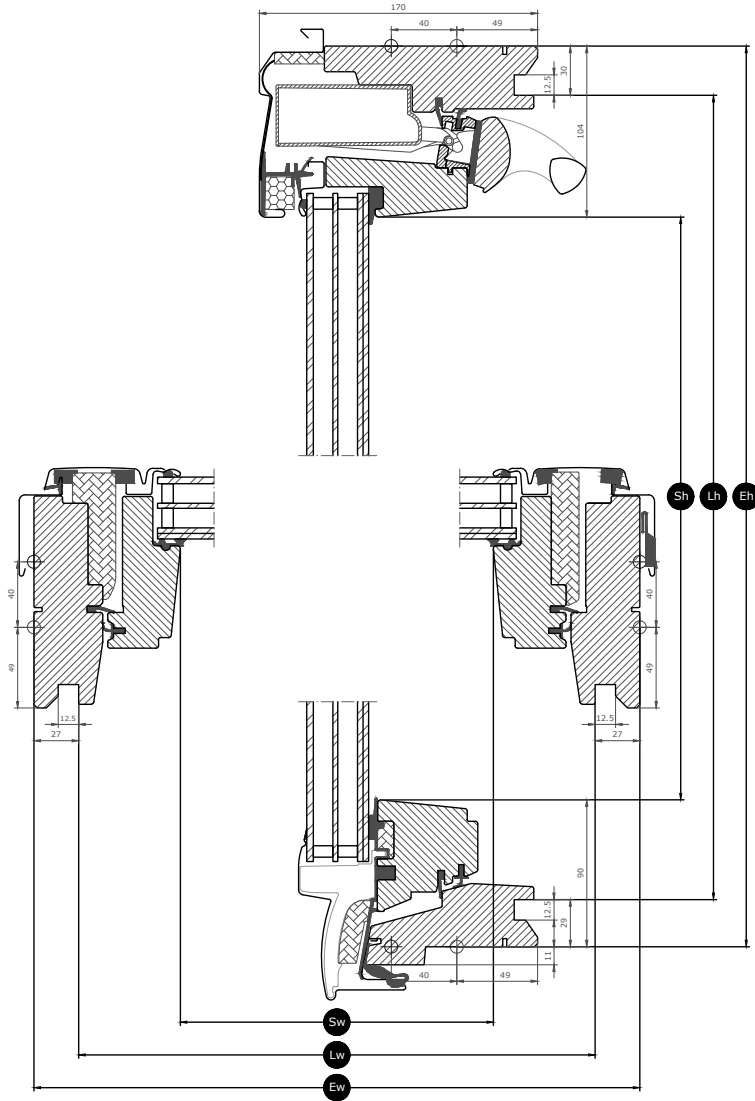







Please note that the view of the cross section is from bottom to top



Width		FK--	MK--	PK--	SK--
Sw	Sash aperture width	481	601	763	961
Lw	Distance between lining grooves, width	605	725	887	1085
Ew	Exterior frame width	660	780	942	1140

Height		--06	--08
Sh	Sash aperture height	984	1204
Lh	Distance between lining grooves, height	1119	1339
Eh	Exterior frame height	1178	1398

Glazing features

Glazing 86		
	Heat insulation The low energy glazing unit reduces heat loss through the window and enhanced indoor comfort.	$U_g = 0.6$
	Solar gain In colder climates and in rooms with large window areas, solar gain provides a better indoor climate during winter periods.	0.44
	Solar protection In warm climates and in rooms with large window areas, a sun protective glazing unit provides a better indoor climate during summer periods.	★★★★☆
	Security Thicker laminated inner glass increases resistance to manual attack (burglary).	★★★★☆
	Safety lamination Prevents glass from falling into the room in case of accidental breakage.	✓
	Toughened glass Adds strength to the outer glass surface to protect from wayward balls and extreme weather such as heavy storms and hail.	✓
	UV filter Protects your interior furnishings and flooring from fading due to the sun's harmful UV rays.	✓
	Rain noise reduction Rain noise reduction creates a barrier between the window and the weather outside for undisturbed moments during rainy days – or nights.	✓
	Easy-to-clean Dirt-repellent coating lets you spend less time cleaning and more time enjoying the view.	✓
	Anti-dew The anti-dew coating significantly reduces the days with dew on the outer glass and thus gives you a clear view.	✓

Glazing structure

Glazing unit	Composition (from inside to outside)
Triple-glazed	6.8 mm laminated float glass - 13 mm Argon - 3 mm heat strengthened glass - 13 mm Argon - 4 mm toughened glass

Technical values for the window

Overview of technical values for the product, covering among other, CE marking in accordance with EN 14351-1.

Window characteristics	Performance
Thermal transmittance (U-value)	1.0 W/(m ² K)
Light transmittance (τ _v)	0.62
Total solar energy transmittance (g-value)	0.44
Sound insulation (R _w)	37(-2;-4)
Air permeability, [class]	4
External fire performance - British [class]	AC
External fire performance - European [class]	npd
Impact resistance [class]	3
Load-bearing capacity of safety devices	✓
Reaction to fire [class]	C-s1,d2
Resistance to snow load	See glazing composition
Resistance to wind load [class]	C3 (>-SK08: NPD)
Water tightness [class]	E900

NPD: No Performance Determined

Visible features



Window operator, electric

Fully-integrated mains-powered motor is hidden from view in the top of the frame and is operated by remote control.



Integrated rain sensor

The window closes automatically in the event of rain or is prevented from opening thanks to the rain sensor.



TripleProtect gaskets

All TripleProtect roof windows include extra gaskets for special protection in cold climates.



Frame hinge, centre-pivot, side

Durable hinge design allows for reliable operation and enables the sash to be rotated for easy cleaning of the outer glass.



Interior insulation, frame top sides

Innovative ThermoTechnology™ insulation is integrated into the top frame sides of the window to increase energy-efficiency.



Barrel bolt

The barrel bolt can be placed into the integrated barrel bolt bushing to secure the window for cleaning of outer glass surface or for safe ventilation.



Data plate

Every VELUX roof window has a unique data plate with information that can be used to look up CE marking documentation, when purchasing accessories or in case of service or replacement.

Interior finish

Material Description	White-painted Finished with triple coat, white painted.
Colour code NCS, inner surface	S 0500-N
Colour code nearest RAL, inner surface	9003

Exterior covers

The availability of the variants listed below may change. For the most accurate and up to date information, please refer to the current product catalogue or price list.

Material Description	Aluminium, dark grey Dark grey	Untreated copper
Colour code NCS, outer surface	S 7500-N	No colour code
Colour code nearest RAL, outer surface	7043	No colour code

Cleaning and maintenance



To clean the outer glass surface from the inside, rotate sash manually and secure in cleaning position with barrel bolts.



VELUX repair and maintenance kits are available.

Guarantee period

Flashings and installation products

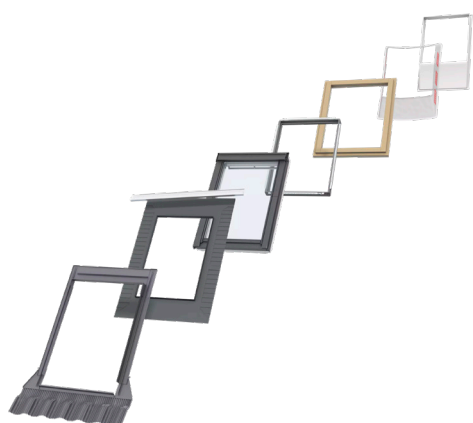

Flashings

Install the VELUX roof window in virtually any roofing material by using genuine VELUX flashing solutions. Our flashings are designed specifically for the exact size and shape of the roof windows to create perfect, watertight fit. Flashings can also be used to combine multiple roof windows.

Installation products

Ensure a proper installation and an air- and watertight connection between the window and roof with VELUX installation products. All installation products are designed to perfectly fit the roof window for a reliable and durable result.

Blinds, awnings and shutters

Complete the VELUX roof window installation with roller shutters and awning blinds for heat protection and interior blinds for light dimming, blackout and insect protection. Choose from a wide range of manually operated or remote-controlled products that are made to fit the particular window type and size. Please contact your local VELUX sales company for more details about compatibility.

VELUX ACTIVE with NETATMO compatibility

The VELUX electric 230 V roof windows GGL and GGU are wired solutions prepared for connection with a switch range or building management system and therefore not VELUX ACTIVE with NETATMO compatible.

If compatibility with VELUX ACTIVE with NETATMO is required, please choose our remote-controlled GGL/GGU complete with wall switch.

Further information

We reserve the right to make technical changes.

For more information on our products, please visit <https://velux.com>.

Technical information

VELUX electric roof window GGL	Installation and use	The window is classified in protection class IP44. The window operator is hidden in the top cover and functions at temperatures between -10 °C and +60 °C. Installation in rooms with a high level of humidity must comply with relevant regulations (contact a qualified electrician if necessary).
	Window opening	The window operator permits a maximum opening of 200 mm within 35 seconds. The chain engages and disengages automatically when the window is closed.
	Compatibility	The roof window is designed for integration into any building management system and can be controlled by a wide range of switches. The roof window is prepared for subsequent installation of VELUX electric exterior decoration and sunscreening products. Connection to non-compatible products may cause damage or malfunction.
	Connection	The window is equipped with a 4-m 6-core cable (H05VV-F) fitted with a plug used for testing the functionality of the window. Use ZZZ 275 Testkit for installation of electric window. After testing of the window, the final connection of the cable to the mains supply is done by a certified electrician.
Integrated rain sensor	Materials	Gold-coated sensor, Grey (RAL 7022)
	Size and weight description	N/A
	Power consumption	N/A
Window operator, electric	Materials	Motor casing of polybutulene terephthalate (PBT) with glass fibre, black (NCS S 9000-N). Stainless steel chain.
	Size and weight description	362 x 50 x 110 mm (W x H x D), 0.987 kg
	Power consumption	230/240 V a.c. – 50 Hz / 40 VA. Stand-by power consumption (including rain sensor): max 0.5 W. Additional stand-by power consumption for MML, SML or DML: 0,6 W. The operation of window and suncreening product (3 cycles per day) will increase the energy consumption by approx 2 kWh/year.
	Motor capacity	Traction capacity: Min 225 N Pressure capacity: Min 150 N