

# VELUX electric roof window GGL

Glazing 57F

**VELUX®**



15°-90°

The VELUX electric, centre-pivot roof window GGL is a wired solution that operates remotely using a wall switch – perfect for both in-reach and out-of-reach installations. The roof window has an integrated and silent motor. And if it rains, the rain sensor automatically closes the window.

- Rain sensor automatically closes the window in the event of rain.
- Mains-powered to allow for complete, seamless integration of your roof window into your home.
- The motor is hidden in the top cover and totally invisible from view.
- Easily control your roof window with the wireless wall switch that offers simple open/close/stop functionality.
- Entrapment control detects objects in the path of the window.
- Silent motor keeps rooms quiet for sleeping children or simply for improved well-being.
- Compatible with VELUX ACTIVE with NETATMO for a better indoor climate with sensor-based ventilation. Remote controlled via smartphone or voice.



**CEKAL**  
VITRAGE ISOLANT

## Application guidance

The window can be installed in roof pitches between 15° and 90° to the horizontal.



VELUX electric and solar roof windows are easily operated by a wireless wall switch, providing fresh air at the touch of a button. Perfect for both within-reach and out-of-reach applications where extra comfort and convenient operation is required. For optimum view, choose longer roof windows for lower roof pitches.

## Available sizes and daylight area

	550 mm	780 mm	942 mm	1140 mm	1340 mm
778 mm	GGL CK02 (0.22) [0.10]				
978 mm	GGL CK04 (0.29) [0.20]	GGL MK04 (0.47) [0.28]	GGL PK04 (0.60) [0.33]		GGL UK04 (0.91) [0.47]
1178 mm		GGL MK06 (0.59) [0.28]		GGL SK06 (0.95) [0.39]	
1398 mm		GGL MK08 (0.72) [0.28]		GGL SK08 (1.16) [0.39]	GGL UK08 (1.40) [0.46]

All measurements are in mm. ( ) = Effective daylight area, m<sup>2</sup> [ ] = Geometric free area, m<sup>2</sup>

# Cross section dimensions



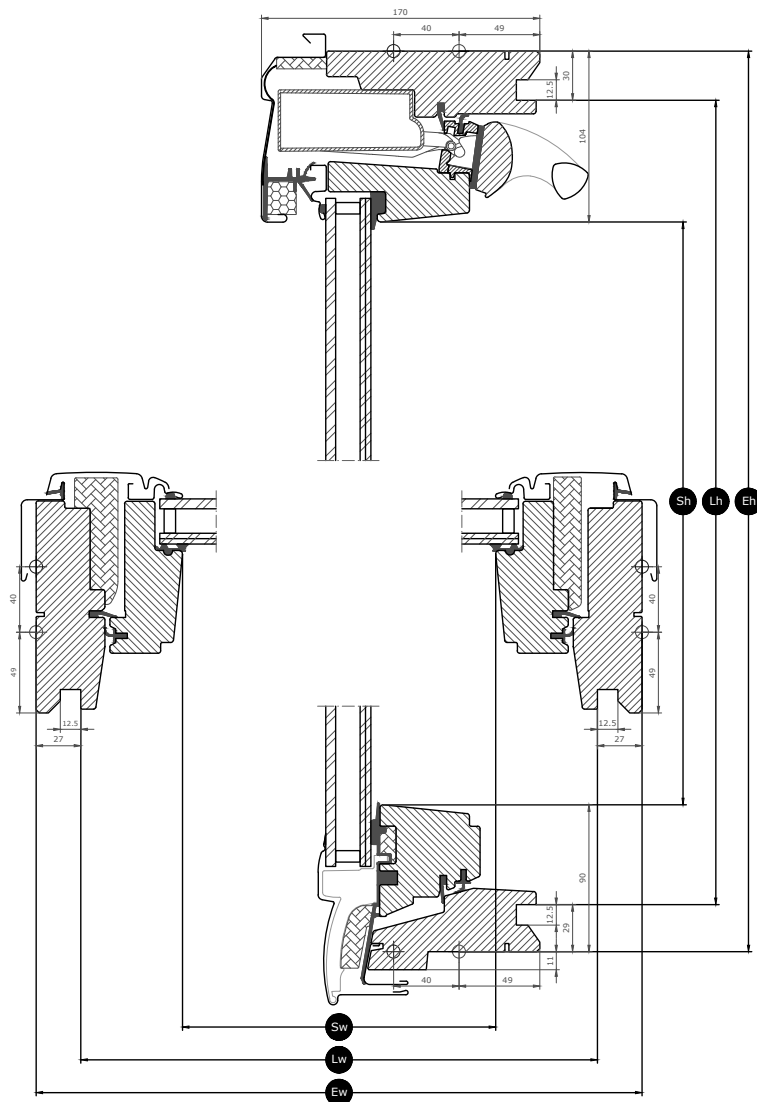







Please note that the view of the cross section is from bottom to top



Width		CK--	MK--	PK--	SK--	UK--
Sw	Sash aperture width	371	601	763	961	1161
Lw	Distance between lining grooves, width	495	725	887	1085	1285
Ew	Exterior frame width	550	780	942	1140	1340

Height		--02	--04	--06	--08
Sh	Sash aperture height	584	784	984	1204
Lh	Distance between lining grooves, height	719	919	1119	1339
Eh	Exterior frame height	778	978	1178	1398

## Glazing features

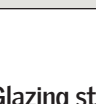
Glazing 57F		
	<b>Heat insulation</b> The low energy glazing unit reduces heat loss through the window and enhanced indoor comfort.	$U_g = 1.0$
	<b>Solar gain</b> In colder climates and in rooms with large window areas, solar gain provides a better indoor climate during winter periods.	<b>0.30</b>
	<b>Solar protection</b> In warm climates and in rooms with large window areas, a sun protective glazing unit provides a better indoor climate during summer periods.	★★★★
	<b>Security</b> Thicker laminated inner glass increases resistance to manual attack (burglary).	★★☆☆
	<b>Safety lamination</b> Prevents glass from falling into the room in case of accidental breakage.	✓
	<b>Toughened glass</b> Adds strength to the outer glass surface to protect from wayward balls and extreme weather such as heavy storms and hail.	✓
	<b>UV filter</b> Protects your interior furnishings from fading due to the sun's harmful UV rays.	✓
	<b>Rain noise reduction</b> Rain noise reduction creates a barrier between the window and the weather outside for undisturbed moments during rainy days – or nights.	✓
	<b>Easy-to-clean</b> Dirt-repellent coating lets you spend less time cleaning and more time enjoying the view.	✓
	<b>Anti-dew</b> The anti-dew coating significantly reduces the days with dew on the outer glass and thus gives you a clear view.	

### Glazing structure

Glazing unit	Composition (from inside to outside)
Double-glazed	6.8 mm laminated float glass - 16 mm Argon - 6 mm toughened glass

## Technical values for the window

---

Overview of technical values for the product, covering among other, CE marking in accordance with EN 14351-1.

Window characteristics	Performance
Thermal transmittance (U-value)	1.3 W/(m <sup>2</sup> K)
Light transmittance (τ <sub>v</sub> )	0.60
Total solar energy transmittance (g-value)	0.30
Sound insulation (R <sub>w</sub> )	37(-1;-3)
Air permeability, [class]	4
External fire performance - British [class]	AC
External fire performance - European [class]	npd
Impact resistance [class]	3
Load-bearing capacity of safety devices	√
Reaction to fire [class]	C-s1,d2
Resistance to snow load	See glazing composition
Resistance to wind load [class]	C3 (>SK08: NPD)
Water tightness [class]	E900

NPD: No Performance Determined

## Visible features

---



### Window operator, electric

Fully-integrated mains-powered motor is hidden from view in the top of the frame and is operated by remote control.



### Integrated rain sensor

The window closes automatically in the event of rain or is prevented from opening thanks to the rain sensor.



### Ventilation flap

The full-width ventilation flap can be used for ventilation even with a closed window. The ventilation flap is connected to the top sash with the lock casing.



### Blind bracket, electric

Easily install electric blinds on the window without the need for extra tools. Simply click on the blinds in the pre-fitted brackets and they are connected for remote control.



### Frame hinge, centre-pivot, side

Durable hinge design allows for reliable operation and enables the sash to be rotated for easy cleaning of the outer glass.



### Barrel bolt

The barrel bolt can be placed into the integrated barrel bolt bushing to secure the window for cleaning of outer glass surface or for safe ventilation.



### Interior insulation, frame top

Innovative ThermoTechnology™ insulation is integrated into the top frame of the window to increase energy-efficiency.



### Data plate

Every VELUX roof window has a unique data plate with information that can be used to look up CE marking documentation, when purchasing accessories or in case of service or replacement.

## Interior finish

---

Material Description	Clear lacquer Finished with triple coat, clear lacquered.	White-painted Finished with triple coat, white painted.
Colour code NCS, inner surface	No colour code	S 0500-N
Colour code nearest RAL, inner surface	No colour code	9003

## Exterior covers

---

Material Description	Aluminium, dark grey Dark grey
Colour code NCS, outer surface	S 7500-N
Colour code nearest RAL, outer surface	7043

## Cleaning and maintenance

---



To clean the outer glass surface from the inside, rotate sash manually and secure in cleaning position with barrel bolts.



VELUX repair and maintenance kits are available.

## Guarantee period

---

## Flashings and installation products

---



### Flashings

Install the VELUX roof window in virtually any roofing material by using genuine VELUX flashing solutions. Our flashings are designed specifically for the exact size and shape of the roof windows to create perfect, watertight fit. Flashings can also be used to combine multiple roof windows.

### Installation products

Ensure a proper installation and an air- and watertight connection between the window and roof with VELUX installation products. All installation products are designed to perfectly fit the roof window for a reliable and durable result.

## Blinds, awnings and shutters

---

Complete the VELUX roof window installation with roller shutters and awning blinds for heat protection and interior blinds for light dimming, blackout and insect protection. Choose from a wide range of manually operated or remote-controlled products that are made to fit the particular window type and size. Please contact your local VELUX sales company for more details about compatibility.

## VELUX ACTIVE with NETATMO compatible

---



Compatible with VELUX ACTIVE with NETATMO for a better indoor climate with sensor-based ventilation. Remote controlled via smartphone or voice.



## Further information

---

We reserve the right to make technical changes.

For more information on our products, please visit <https://velux.com>.

## Technical information

<b>VELUX electric roof window GGL</b>	<b>Installation and use</b>	The window is classified in protection class IP44. The window operator is hidden in the top cover and functions at temperatures between -10 °C and +60 °C. Installation in rooms with a high level of humidity must comply with relevant regulations (contact a qualified electrician if necessary).
	<b>Window opening</b>	The window operator permits a maximum opening of 200 mm within 35 seconds. Due to a shorter chain, small/special window sizes have a different window opening. Window opening for sizes --K01 and --K02 = 135 mm. Window opening for sizes --K25 and --K27 = 38 mm. The chain engages and disengages automatically when the window is closed.
	<b>Compatibility</b>	The roof window is based on radio frequency (RF) technology, 868 MHz range, and is compatible with other VELUX products with the io-homecontrol® logo. The roof window is prepared for subsequent installation of VELUX electric interior and exterior decoration and sunscreening products. It is compatible with all VELUX electric and solar decoration and sunscreening products but we recommend using the electric ones. Connection to non-compatible products may cause damage or malfunction.
<b>Pre-paired wall switch</b>	<b>Connection</b>	The window is equipped with a 4 m 2-core cable (H05VV-F) with a standard mains plug for connection to the mains supply (2.5 m for the UK).
	<b>Materials</b>	ABS plastic, white (NCS S 1000-N)
	<b>Size and weight description</b>	8.2 cm x 8.2 cm x 1.7 cm, 0.125 kg.
<b>Integrated rain sensor</b>	<b>Installation and use</b>	The wall switch is for indoor use only, between a minimum ambient temperature 5 °C and a maximum ambient temperature 45 °C. It can be used in a dry or humid environment (such as a living room or a bathroom). Radio frequency range: 300 m range open field. Depending on the building construction, the indoor range is approximately 30 m.
	<b>Power consumption</b>	2 x alkaline AAA (1.5V) batteries Expected battery lifetime: Up to 1 year.
	<b>Materials</b>	Gold-coated sensor, Grey (RAL 7022)
<b>Window operator, electric</b>	<b>Size and weight description</b>	N/A
	<b>Power consumption</b>	N/A
	<b>Materials</b>	Motor casing of polybutulene terephthalate (PBT) with glass fibre, black (NCS S 9000-N). Stainless steel chain.
<b>Window operator, electric</b>	<b>Size and weight description</b>	362 x 50 x 110 mm (W x H x D), 0.987 kg
	<b>Power consumption</b>	230/240 V a.c. – 50 Hz / 40 VA. Stand-by power consumption (including rain sensor): max 0.5 W. Additional stand-by power consumption for MML, SML or DML: 0.6 W. The operation of window and suncreening product (3 cycles per day) will increase the energy consumption by approx 2 kWh/year.
	<b>Motor capacity</b>	Traction capacity: Min 225 N Pressure capacity: Min 150 N