

VELUX 2in1 roof window GGLS

Glazing 70

VELUX®



With VELUX 2in1 daylight solution, you will experience an extensive view, increased influx of daylight and an aesthetic design due to extra slim profiles. With two windows in one frame, this daylight solution allows for easy installation.

- Enjoy an extensive view to the outside and more daylight due to extra slim frame profiles
- One frame module allows a simple well-known installation process with few components.
- One-piece top cover and slim profile covers feature a very aesthetic integration in the roof.
- The glazing comes standard with premium features like safety lamination, toughened glass, UV filter and our unique rain noise reduction.
- Upgrade to a remote-controlled mains- or solar-powered motor for extra convenience.
- Get more control over your indoor climate with our wide range of accessories.
- Quickly and easily add blinds by simply clicking them into the pre-fitted brackets.



Application guidance

The window can be installed in roof pitches between 15° and 90° to the horizontal.



Manually top-operated, centre-pivot roof windows make it possible to place furniture directly below the window without obstructing the window operation. The 2in1 roof window GGLS consists of one openable centre-pivot window and one fixed window in one frame to provide extra daylight and an extensive view while offering all the benefits of our centre-pivot window. To benefit optimally from the wide view, we recommend an installation height that allows for a clear sight line to the outside from both a standing and seated position.

Available sizes and daylight area

	1270 mm	1390 mm	1510 mm	1552 mm
1178 mm	GGLS FFK06 (0.94) [0.54]	GGLS FMK06 (1.06) [0.66]	GGLS MMK06 (1.18) [0.66]	GGLS FPK06 (1.22) [1.08]
1398 mm	GGLS FFK08 (1.16) [0.54]	GGLS FMK08 (1.30) [1.32]	GGLS MMK08 (1.44) [0.66]	GGLS FPK08 (1.50) [0.54]

All measurements are in mm. () = Effective daylight area, m² [] = Geometric free area, m²

Cross section dimensions



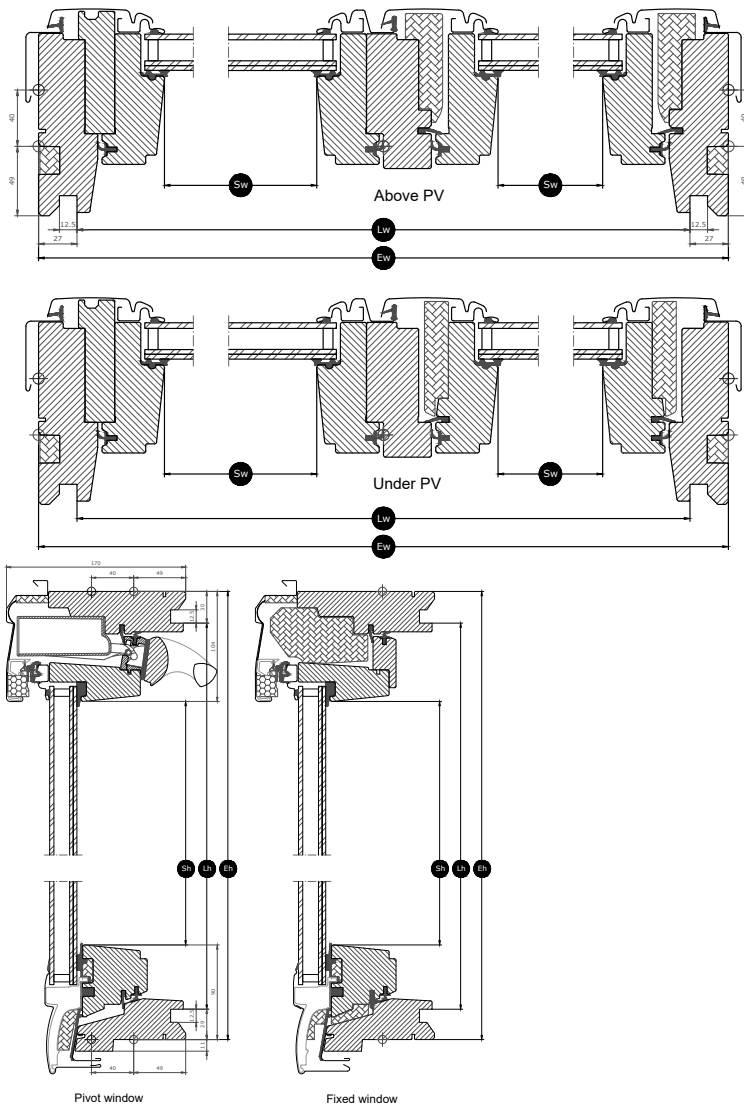





Please note that the view of the cross section is from bottom to top.

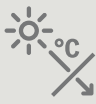

Width		FFK--	FMK--	FPK--	MMK--
Sw	Sash aperture width	481, 481	481, 601	481, 763	601, 601
Lw	Distance between lining grooves, width	1216	1336	1498	1456
Ew	External frame width	1270	1390	1552	1510

Height		--06	--08
Sh	Sash aperture height	984	1204
Lh	Distance between lining grooves, height	1119	1339
Eh	External frame height	1178	1398

Glazing features

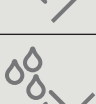
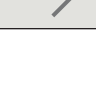
Glazing 70		
	Heat insulation The low energy glazing unit reduces heat loss through the window and enhanced indoor comfort.	$U_g = 1.0$
	Solar gain In colder climates and in rooms with large window areas, solar gain provides a better indoor climate during winter periods.	0.46
	Solar protection In warm climates and in rooms with large window areas, a sun protective glazing unit provides a better indoor climate during summer periods.	★★★★☆
	Security Thicker laminated inner glass increases resistance to manual attack (burglary).	★★★★☆
	Safety lamination Prevents glass from falling into the room in case of accidental breakage.	✓
	Toughened glass Adds strength to the outer glass surface to protect from wayward balls and extreme weather such as heavy storms and hail.	✓
	UV filter Protects your interior furnishings from fading due to the sun's harmful UV rays.	✓
	Rain noise reduction Rain noise reduction creates a barrier between the window and the weather outside for undisturbed moments during rainy days – or nights.	✓
	Easy-to-clean Dirt-repellent coating lets you spend less time cleaning and more time enjoying the view.	
	Anti-dew The anti-dew coating significantly reduces the days with dew on the outer glass and thus gives you a clear view.	

Glazing structure

Glazing unit	Variant composition
Double-glazed	6.8 mm laminated float glass - 16 mm Argon - 4 mm toughened glass

Technical values for the window

Overview of technical values for the product, covering among other, CE marking in accordance with EN 14351-1.

Window characteristics	Performance
Thermal transmittance	1.3 W/(m ² K)
Light transmittance	0.68
Total solar energy transmittance	0.46
Sound insulation	34(-1;-4)
Air permeability	4
External fire performance - British	npd
External fire performance - European	npd
Impact resistance	3
Load-bearing capacity of safety devices	√
Reaction to fire	C-s1,d2
Resistance to snow load	See glazing composition
Resistance to wind load	C3
Water tightness	9A

NPD: No performance determined

Visible features



Control bar

The ergonomic aluminum control bar allows effortless opening and closing of the window. It can also lock the ventilation flap in the ventilation position.



Detachable sash

The fixed sash is detachable and can be taken out for an easier process during service or installation from the inside.

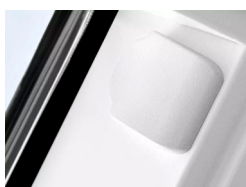

Blind bracket, manual

Easily install blinds on the window without the need for extra tools. Simply click on the blind in the pre-fitted brackets.



Ventilation flap

The full-width ventilation flap can be used for ventilation even with a closed window. The ventilation flap is connected to the top sash with the lock casing.



Frame hinge, centre-pivot, side

Durable hinge design allows for reliable operation and enables the sash to be rotated for easy cleaning of the outer glass.



Interior insulation, frame top sides

Innovative ThermoTechnology™ insulation is integrated into the top frame sides of the window to increase energy-efficiency.



Barrel bolt

The barrel bolt can be placed into the integrated barrel bolt bushing to secure the window for cleaning of outer glass surface or for safe ventilation.



Headlock

When closed, the window is locked firmly into place by the headlock.

Interior finish

Material Description	White-painted Finished with triple coat, white painted.
Colour code NCS, inner surface	S 0500-N
Colour code nearest RAL, inner surface	9003

Exterior covers

Material Description	Aluminium, dark grey Dark grey
Colour code NCS, outer surface	S 7500-N
Colour code nearest RAL, outer surface	7043

Cleaning and maintenance



To clean the outer glass surface from the inside, rotate sash and secure in cleaning position with barrel bolts. The fixed sash can be cleaned outside by opening the left sash (seen from the inside).



VELUX repair and maintenance kits are available.

Guarantee period



The full terms and conditions of the VELUX Product Guarantee are available on our website www.velux.co.uk or www.velux.ie

Flashings and installation products

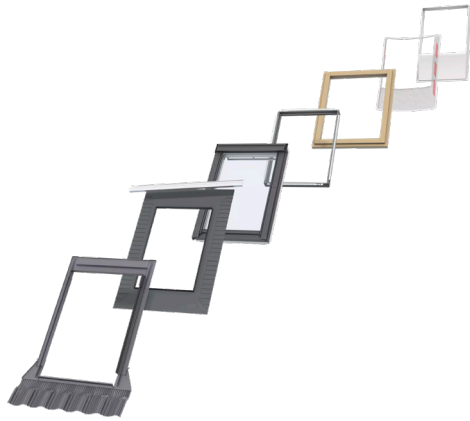

Flashings

Install the VELUX roof window in virtually any roofing material by using genuine VELUX flashing solutions. Our flashings are designed specifically for the exact size and shape of the roof windows to create perfect, watertight fit. Flashings can also be used to combine multiple roof windows.

Installation products

Ensure a proper installation and an air- and watertight connection between the window and roof with VELUX installation products. All installation products are designed to perfectly fit the roof window for a reliable and durable result.

Blinds, awnings and shutters

Complete the VELUX roof window installation with roller shutters and awning blinds for heat protection and interior blinds for light dimming, blackout and insect protection. Choose from a wide range of manually operated or remote-controlled products that are made to fit the particular window type and size. Please contact your local VELUX sales company for more details about compatibility.

Further information

We reserve the right to make technical changes.

For more information on our products, please visit <https://www.velux.co.uk> or <https://www.velux.ie>.